



U.S. DEPARTMENT OF  
**ENERGY**

Office of  
Science

## Science for Energy

31<sup>st</sup> Annual Joint NSLS and CFN User Meeting  
Brookhaven National Laboratory

May 25, 2010

Dr. William F. Brinkman  
Director, Office of Science  
U.S. Department of Energy

# The Office of Science

- **The Office of Science (SC), within DOE focuses on basic science for discovery, innovation, and national need.**
- **Research programs span physics, chemistry, materials science, biology, climate and environmental sciences, applied mathematics, computer science, high energy physics, nuclear physics, plasma physics, fusion energy and more.**
- **The Office of Science provides state-of-the-art open-access R&D user facilities—used by more than 26,000 researchers from universities, other government agencies, and private industry each year.**
- **SC stewards 10 of the 17 DOE national laboratories.**



# SC Request vs. Appropriation (FY 2010 Constant \$s)

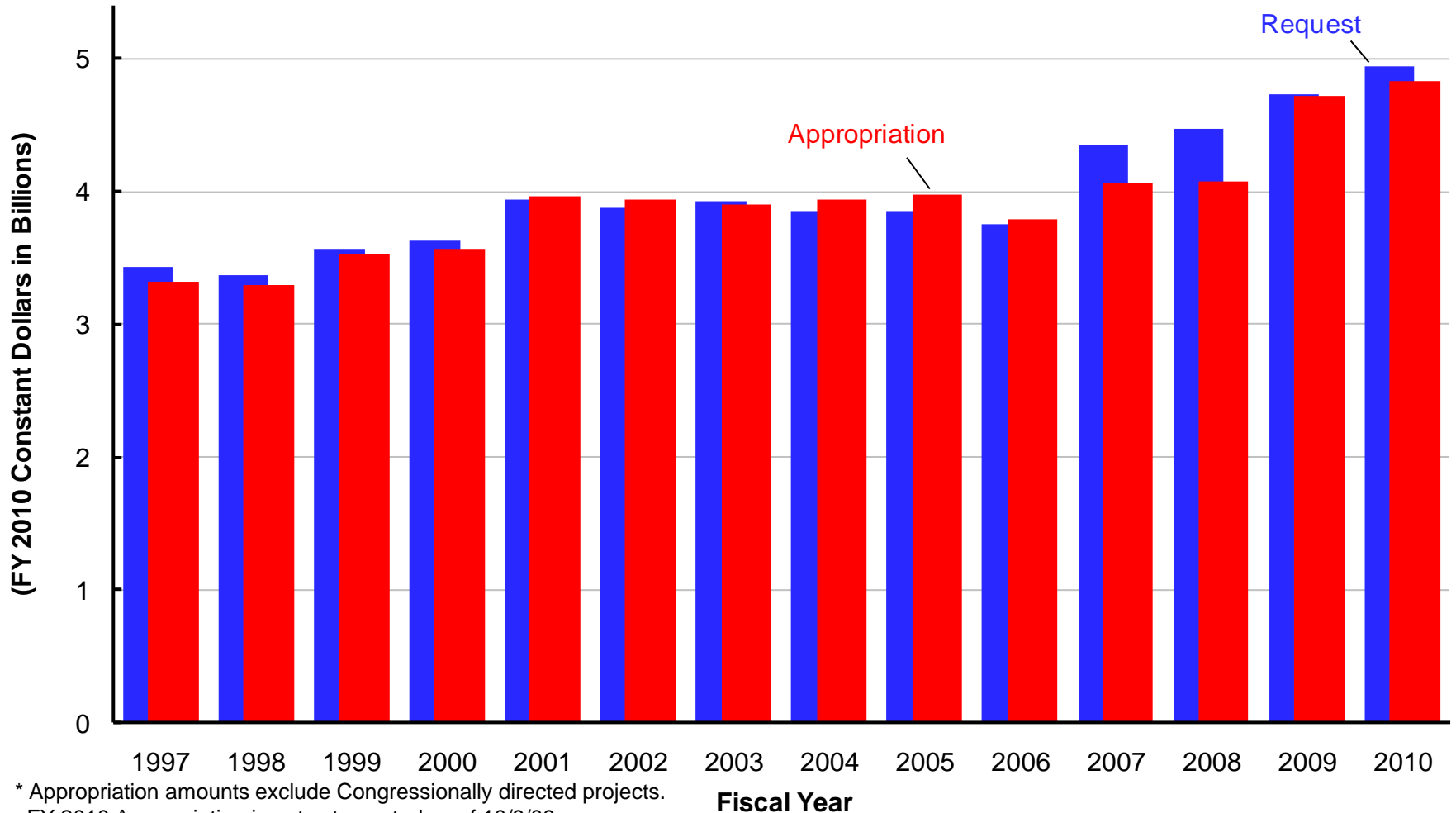

\* Appropriation amounts exclude Congressionally directed projects.  
FY 2010 Appropriation is not yet enacted as of 10/9/09.



# Office of Science (SC) FY 2011 Budget Request to Congress

(B/A in thousands)

	FY 2009		FY 2010	FY 2011		
	Current Base Approp.	Current Recovery Act	Current Approp.	Request to Congress	Request to Congress vs. FY 2010 Approp.	
Advanced Scientific Computing Research.....	358,772	161,795	394,000	426,000	+32,000	+8.1%
Basic Energy Sciences.....	1,535,765	555,406	1,636,500	1,835,000	+198,500	+12.1%
Biological & Environmental Research.....	585,176	165,653	604,182	626,900	+22,718	+3.8%
Fusion Energy Sciences.....	394,518	91,023	426,000	380,000	-46,000	-10.8%
High Energy Physics.....	775,868	232,390	810,483	829,000	+18,517	+2.3%
Nuclear Physics.....	500,307	154,800	535,000	562,000	+27,000	+5.0%
Workforce Development for Teachers & Scientists.....	13,583	12,500	20,678	35,600	+14,922	+72.2%
Science Laboratories Infrastructure.....	145,380	198,114	127,600	126,000	-1,600	-1.3%
Safeguards & Security.....	80,603	—	83,000	86,500	+3,500	+4.2%
Science Program Direction.....	186,695	5,600	189,377	214,437	+25,060	+13.2%
Small Business Innovation Research/Technology Transfer (SC).....	104,905	18,719	—	—	—	—
<b>Subtotal, Science.....</b>	<b>4,681,572</b>	<b>1,596,000</b>	<b>4,826,820</b>	<b>5,121,437</b>	<b>+294,617</b>	<b>+6.1%</b>
Congressionally-directed projects.....	91,064	—	76,890	—	-76,890	-100.0%
Small Business Innovation Research/ Technology Transfer (DOE).....	49,534	36,918	—	—	—	—
Use of prior year balances.....	-15,000	—	—	—	—	—
<b>Total, Office of Science.....</b>	<b>4,807,170</b>	<b>1,632,918</b>	<b>4,903,710</b>	<b>5,121,437</b>	<b>+217,727</b>	<b>+4.4%</b>



# COMPETES Reauthorization

- **The Administration supports House passage of H.R. 5116, as reported by the House Science and Technology Committee.**
- **Would authorize a funding trajectory for FY 2011-2015 that supports the doubling of the Office of Science, the NSF and the bureau of standards from FY 2006-2015.**



# SC Supports World-Leading, Open Access Scientific User Facilities

User numbers continue to increase with more than 26,000 users expected in FY 2011

Breakdown of the expected users in FY 2011 by facility.

Numbers of Users at SC Facilities

	FY 2009	FY 2010 (Est)	FY 2011 (Est)
--	---------	---------------	---------------

ASCR	3,696	3,850	4,025
BES	11,509	12,780	13,560
BER	2,716	2,690	2,690
FES	542	575	580
HEP	2,960	2,600	2,100
NP	3,170	3,260	3,300
<b>Total</b>	<b>24,593</b>	<b>25,755</b>	<b>26,255</b>

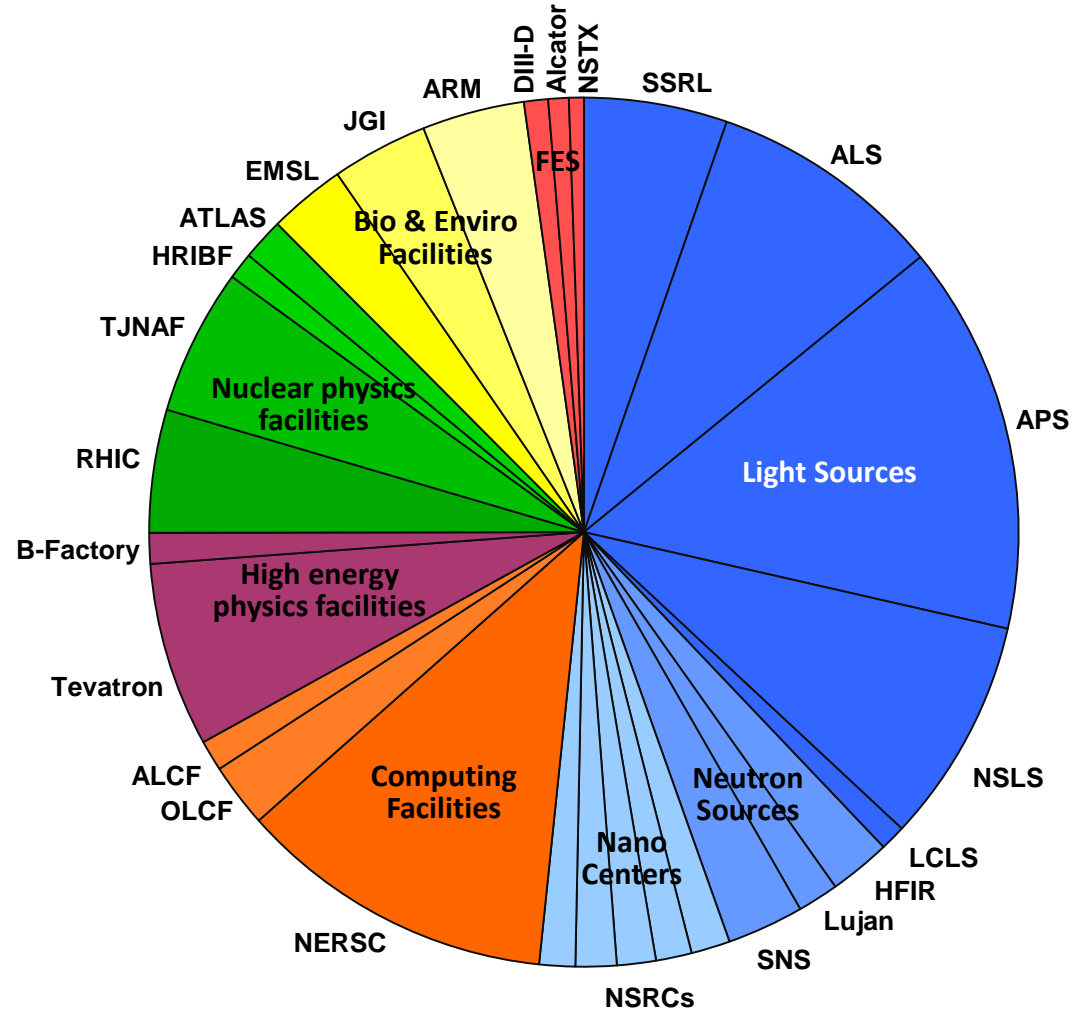

# SC Supports Research at More than 300 Institutions Across the U.S.

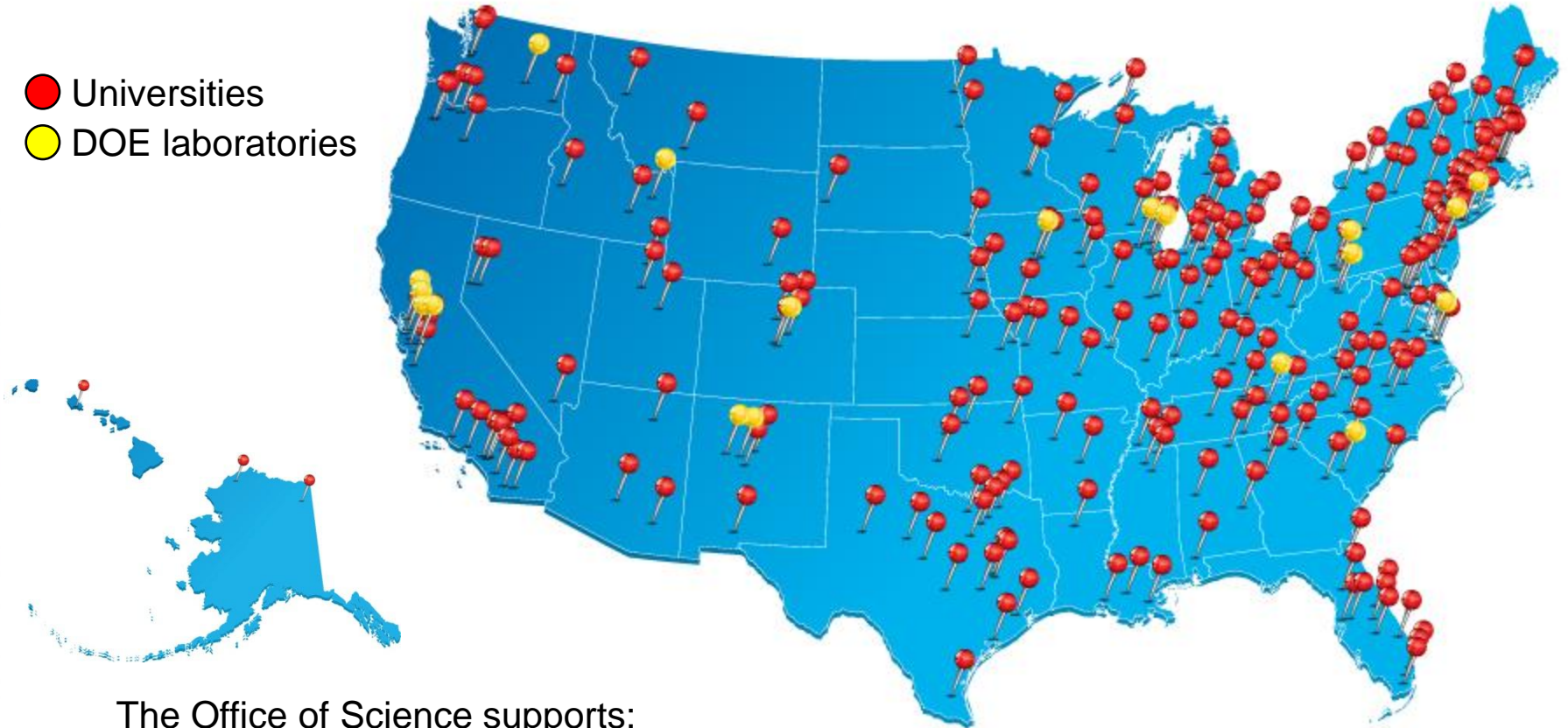

The Office of Science supports:

- **27,000** Ph.D.s, graduate students, undergraduates, engineers, and technicians
- **26,000** users of open-access user facilities
- **300** academic institutions
- **17** DOE laboratories



**New in  
2010!**

# Office of Science Early Career Research Program

*Proposed investment in FY 2011 would bring 60 new scientists into the program*

To support individual research programs of outstanding scientists early in their careers and to stimulate research careers in the disciplines supported by the Office of Science

**Eligibility:** Within 10 years of receiving a Ph.D., either untenured academic assistant professors on the tenure track or full-time DOE national lab employees

**Award Size:**

- University grants \$150,000 per year for 5 years to cover summer salary and expenses

**FY 2010 Results:**

- 69 awards funded via the American Recovery and Reinvestment Act
- 47 university grants and 22 DOE national laboratory awards

**FY 2011 Application Process:**

- Funding Opportunity Announcement issued in Spring 2010
- Awards made in the Second Quarter of 2011

[http://www.science.doe.gov/SC-2/early\\_career.htm](http://www.science.doe.gov/SC-2/early_career.htm)



**New in  
2010!**

# Office of Science Graduate Fellowship Program

*The FY 2011 request would double the number of graduate fellowships*

## **The Administration has requested \$10 million in FY 2011 to fund about 170 additional fellowships.**

**Purpose:** To educate and train a skilled scientific and technical workforce in order to stay at the forefront of science and innovation and to meet our energy and environmental challenges

### **Eligibility:**

- Candidates must be U.S. citizens and a senior undergraduate or first or second year graduate student to apply
- Candidates must be pursuing advanced degrees in areas of physics, chemistry, mathematics, biology, computational sciences, areas of climate and environmental sciences important to the Office of Science and DOE mission

### **Award Size:**

- The three-year fellowship award, totaling \$50,500 annually, provides support towards tuition, a stipend for living expenses, and support for expenses such as travel to conferences and to DOE user facilities.

### **FY 2010 Results:**

- ~150 awards will be made this Spring with FY 2010 and American Recovery and Reinvestment Act funds.

### **FY 2011 Application Process:**

- Funding Opportunity Announcement issued in Fall 2010
- Awards made in March 2011

<http://www.scied.science.doe.gov/SCGF.html>



# The Global Climate Crisis



# Modern CO<sub>2</sub> Concentrations are Increasing

The current concentration is the highest in 800,000 years, as determined by ice core data

## Atmospheric CO<sub>2</sub> at Mauna Loa Observatory

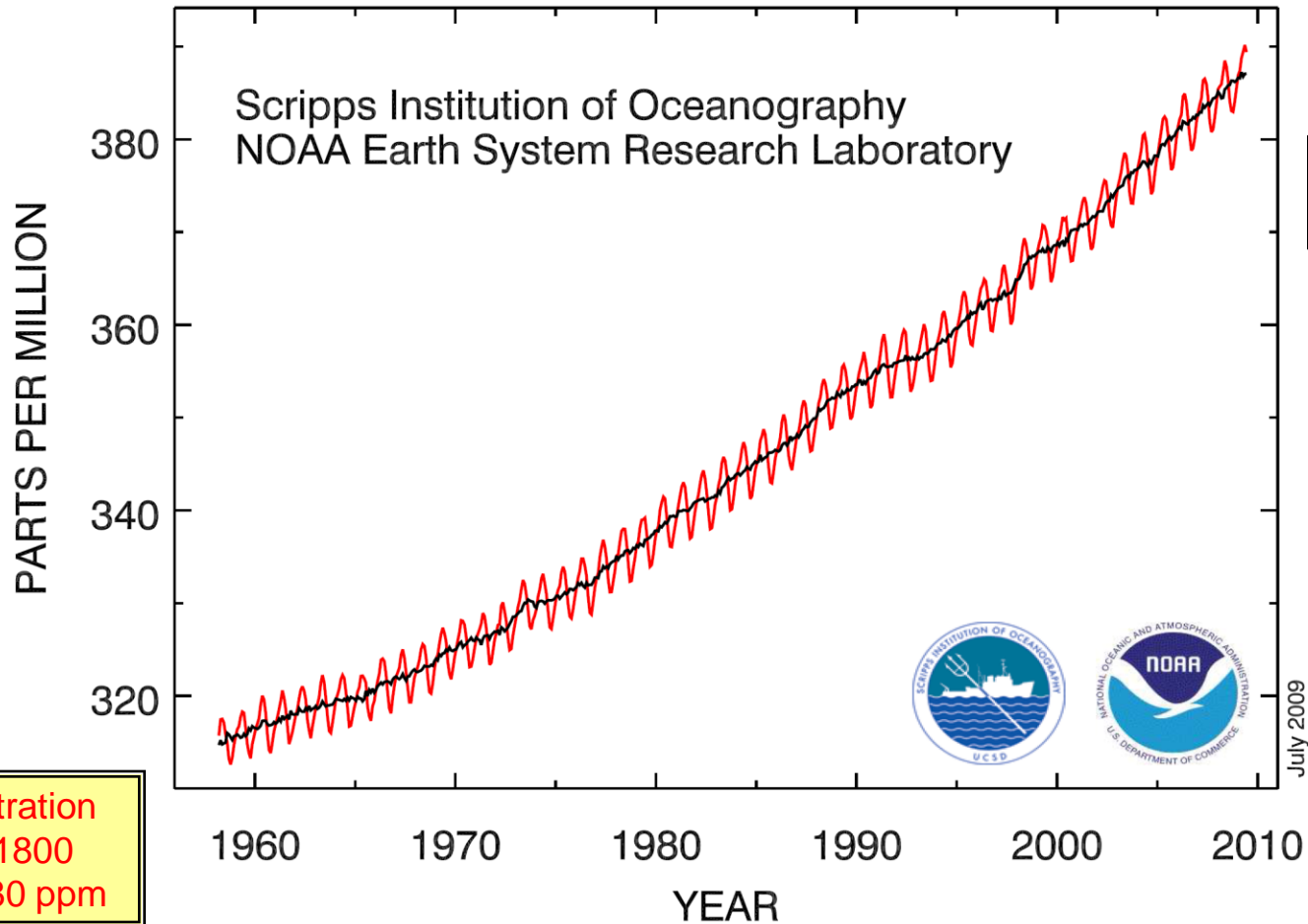

# Greenland Ice Mass Loss – 2002 to 2009

Increasing rates of ice mass loss from the Greenland and Antarctic ice sheets revealed by GRACE (Gravity Recovery and Climate Experiment) satellite:

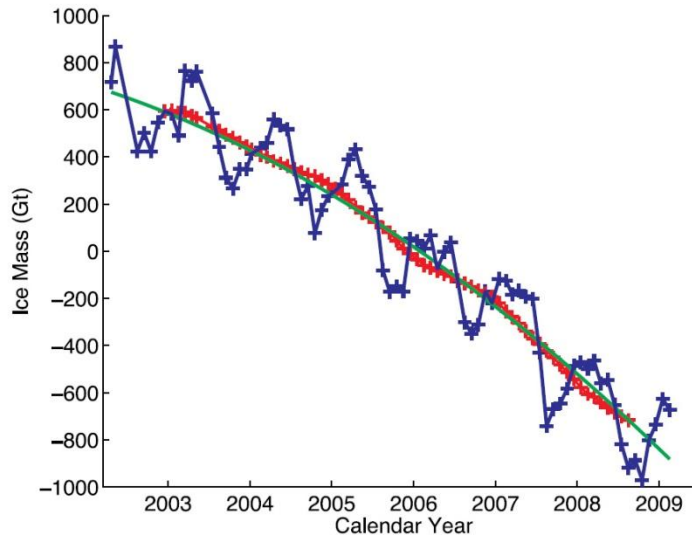

**Figure 1.** Time series of ice mass changes for the Greenland ice sheet estimated from GRACE monthly mass solutions for the period from April 2002 to February 2009. Unfiltered data are blue crosses. Data filtered for the seasonal dependence using a 13-month window are shown as red crosses. The best-fitting quadratic trend is shown (green line). The GRACE data have been corrected for leakage and GIA.

- In Greenland, the mass loss increased from 137 Gt/yr in 2002–2003 to 286 Gt/yr in 2007–2009
- In Antarctica, the mass loss increased from 104 Gt/yr in 2002–2006 to 246 Gt/yr in 2006–2009

I. Velicogna, *Geophysical Research Letters*, VOL. 36, L19503, 2009



# Accounting for Stagnation of Global Average Temperature: The Role of Climate Model Variability

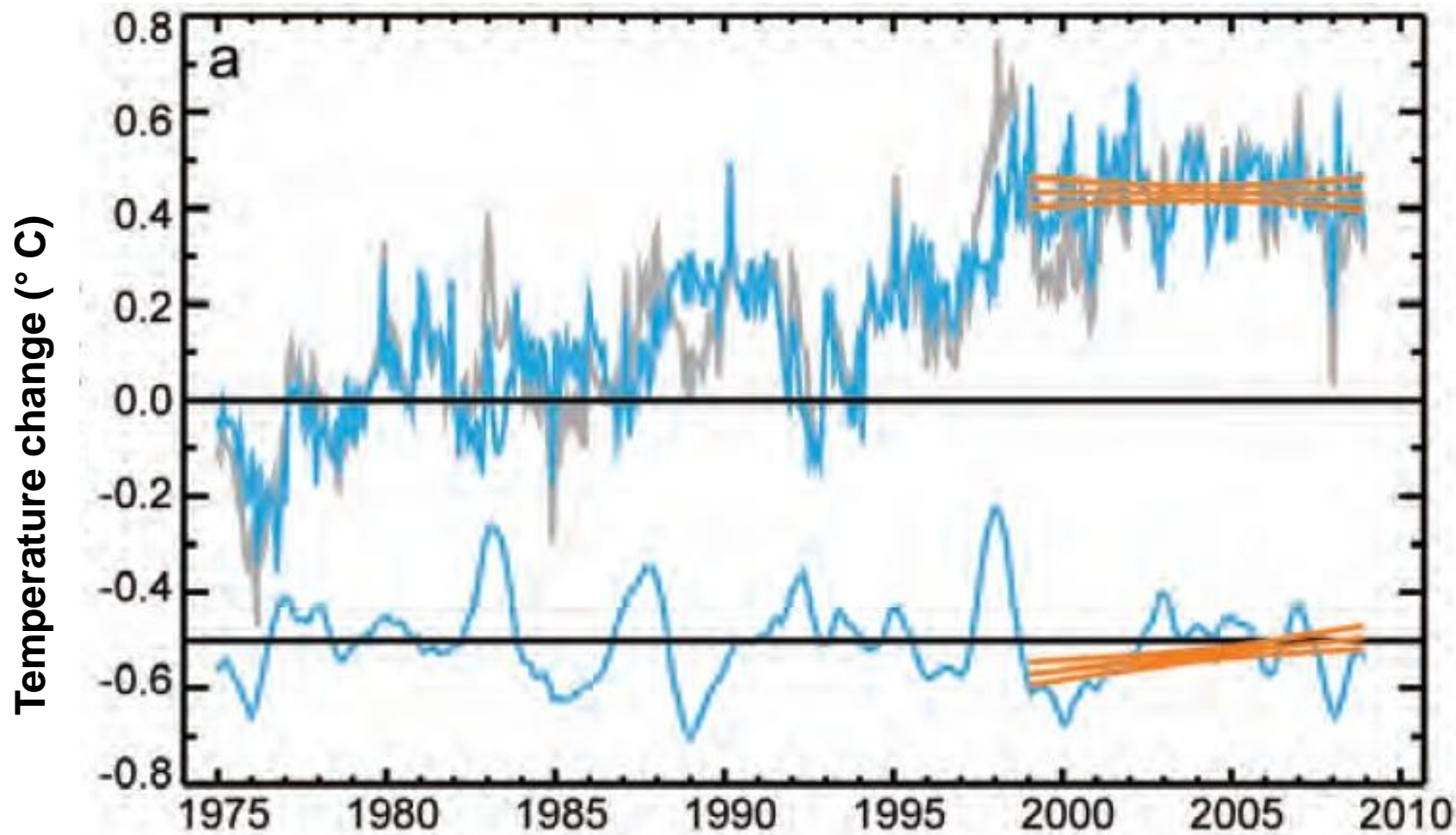

J. Knight et al., *Bull. Amer. Met. Soc.*, "State of the Climate" Supplement, August 2009



U.S. DEPARTMENT OF  
**ENERGY**

Office of  
Science

# Global Surface Temperature Does Not Always Rise

## Observations of Global Surface Temperature

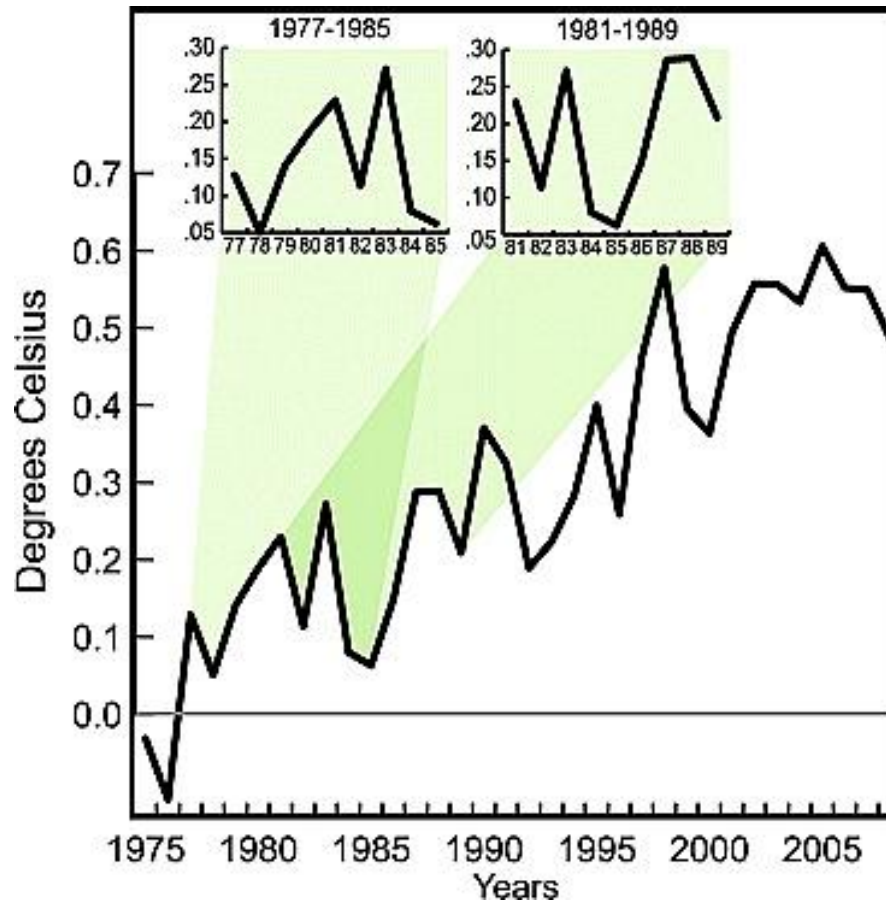

Easterling, D. R., and M. F. Wehner, *Geophys. Res. Lett.*, 36, L08706 (2009).



# Models Predict Flat Periods

## Model of Global Surface Temperature

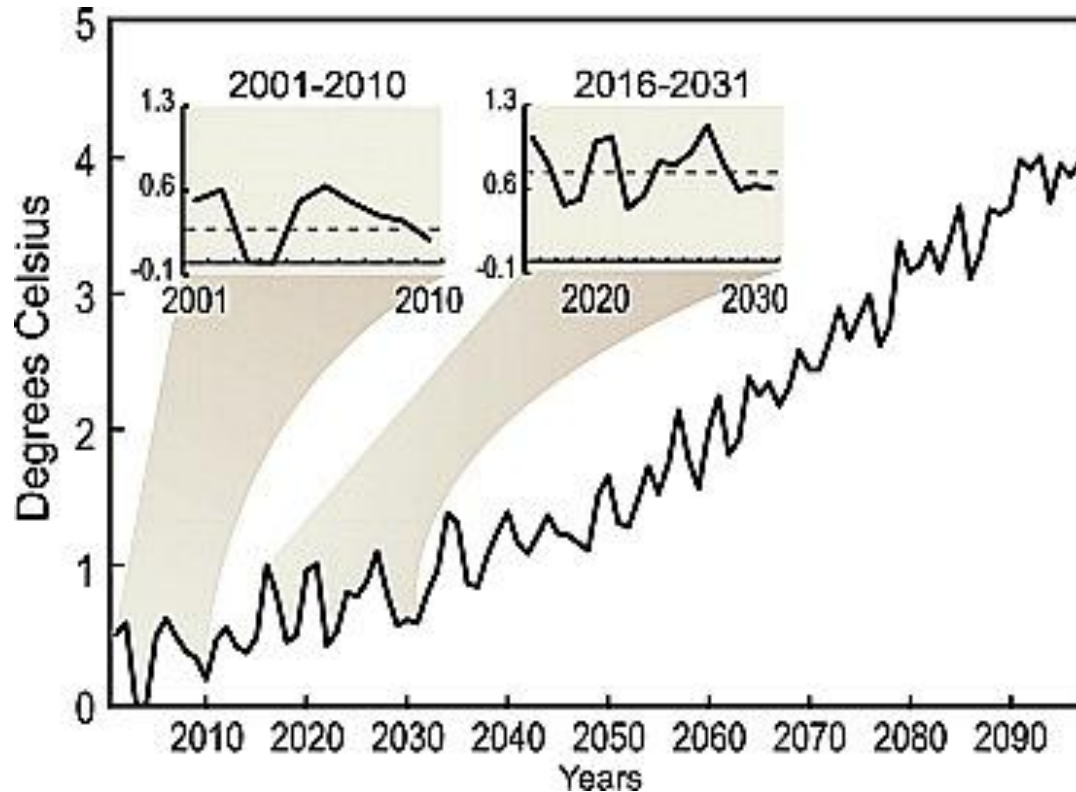

Easterling, D. R., and M. F. Wehner, *Geophys. Res. Lett.*, 36, L08706 (2009).



# Global and U.S. Energy Outlook





# Fossil Fuels Will Continue to Dominate World Energy Supply Under Business as Usual

## IEA World Energy Outlook 2009 Reference Case

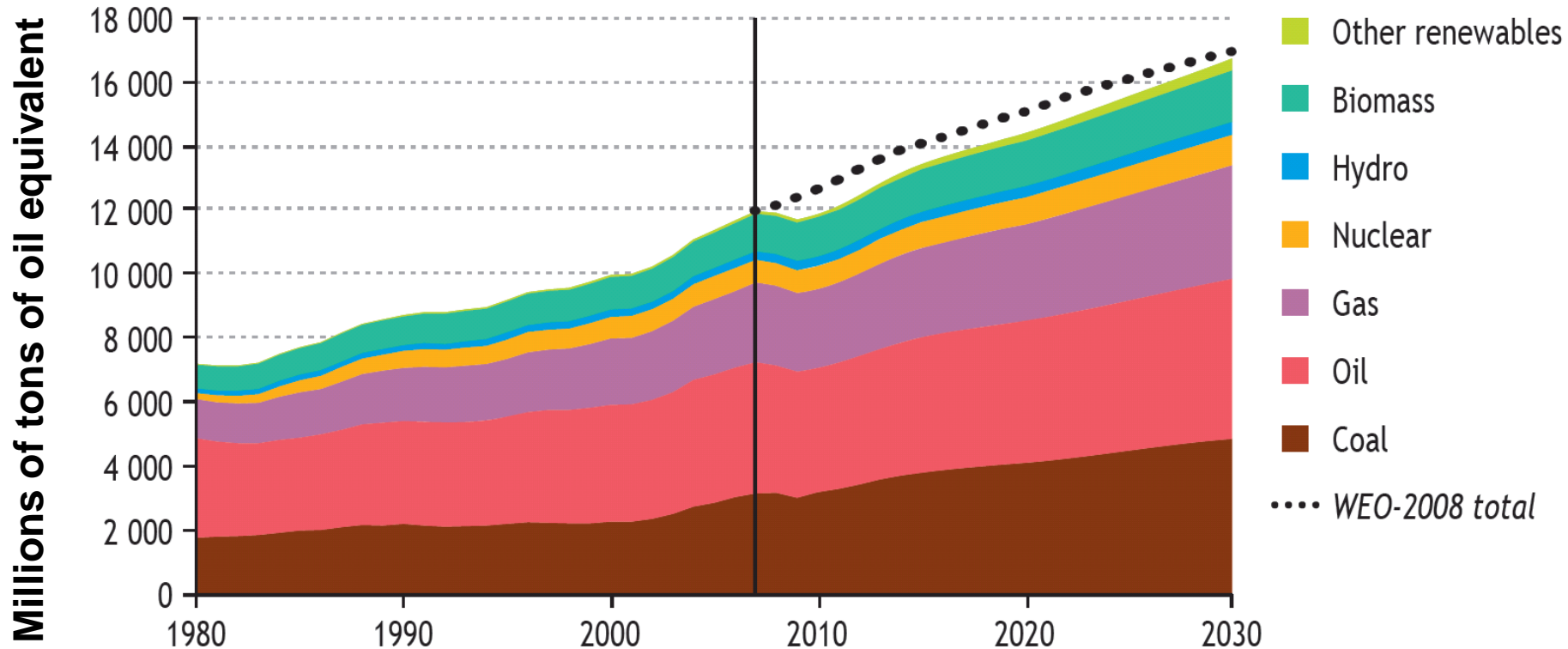

Over 90% of the increase in world primary energy demand between 2007 and 2030 is projected to come from non-OECD countries

Source: International Energy Agency World Energy Outlook, 2009.

# The Market Favors Expanded Use of Unconventional Natural Gas

Today, perhaps the biggest change to the energy system is not expanded use of nuclear or renewable energy, but the development of shale gas formations through horizontal drilling and hydraulic fracturing.

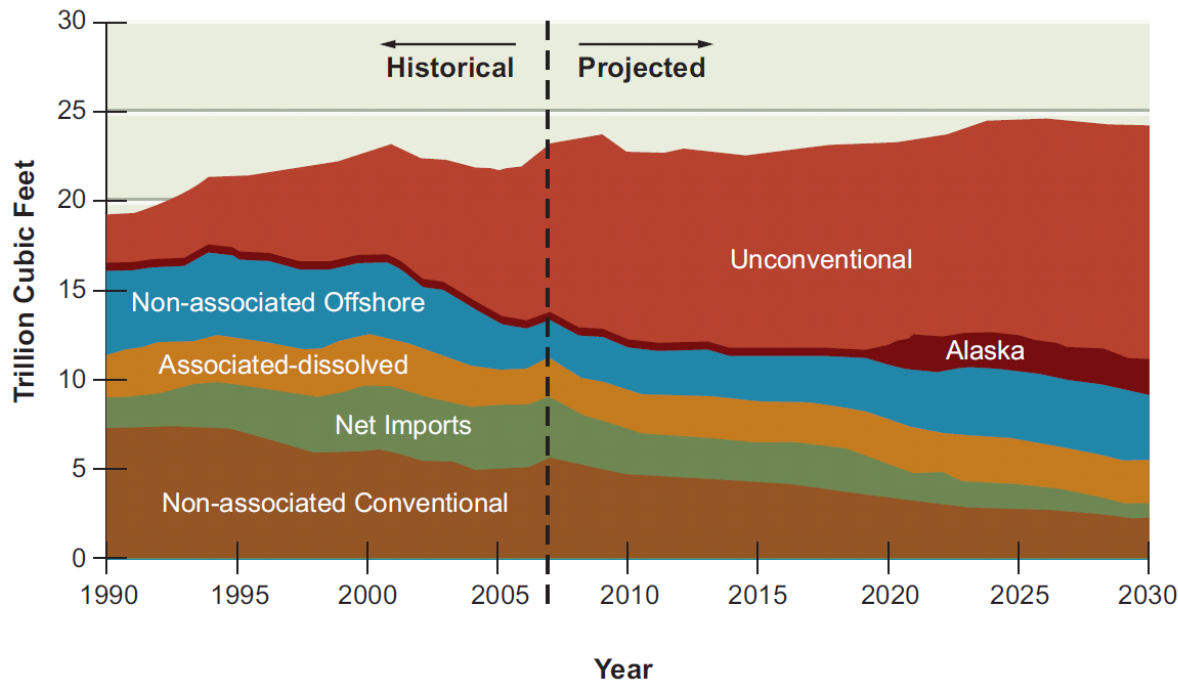

**Proved natural gas reserves at the end of last year were 244.7 trillion cubic feet (tcf), the highest level since reports commenced in 1977.**

**Proved reserves of shale gas grew by 8.9 tcf to 32.8 tcf.**

Source: Department of Energy, Energy Information Administration Annual Energy Outlook 2009, Reference Case.

# U.S. Energy Production and Usage in 2008

Units in Quadrillion BTUs (Quads)

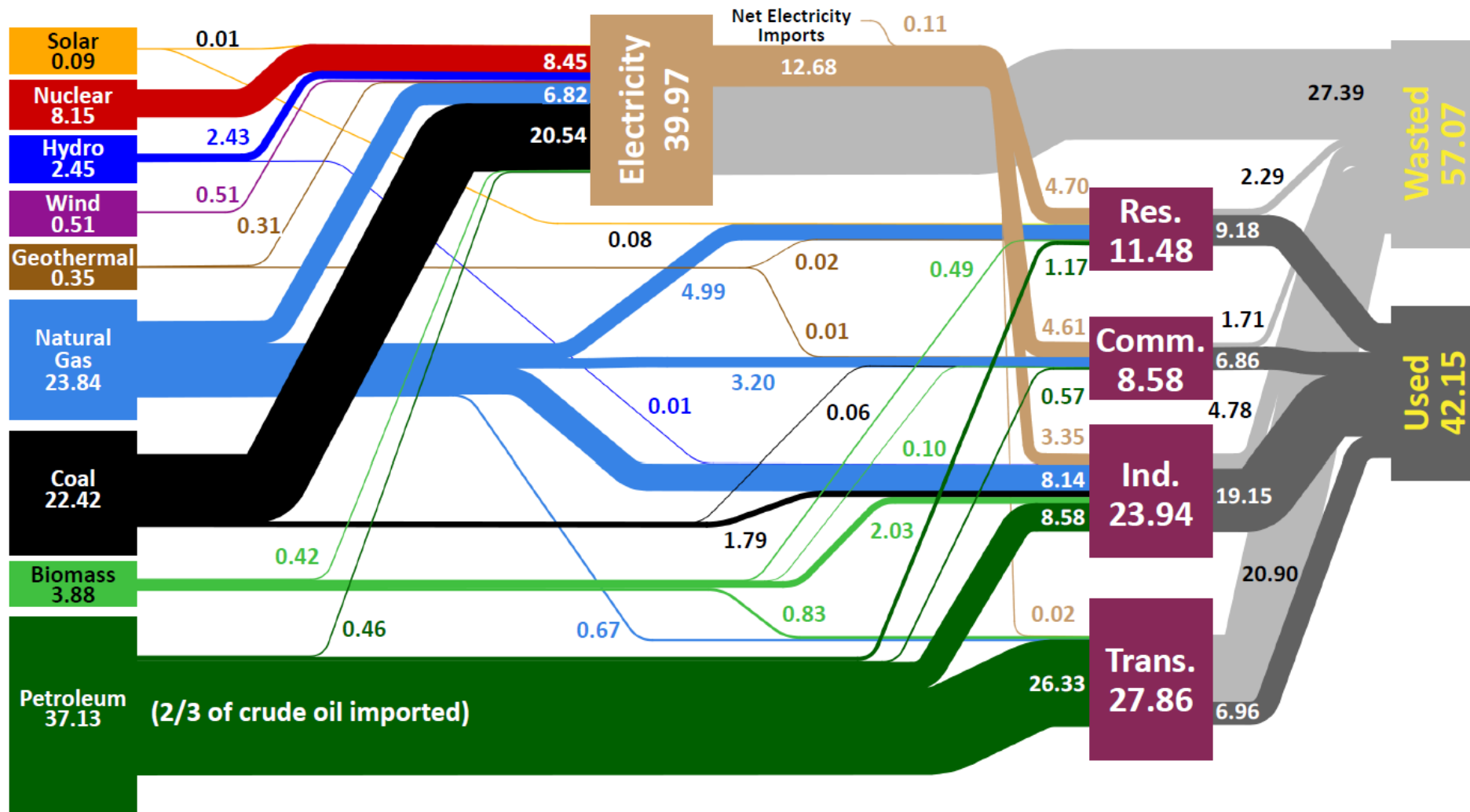

Source: Lawrence Livermore National Laboratory and the Department of Energy, Energy Information Administration, 2009 (based on data from DOE/EIA-0384(2008), June 2009).

# U.S. Carbon Dioxide Emissions in 2008

Units in Millions of Metric Tons

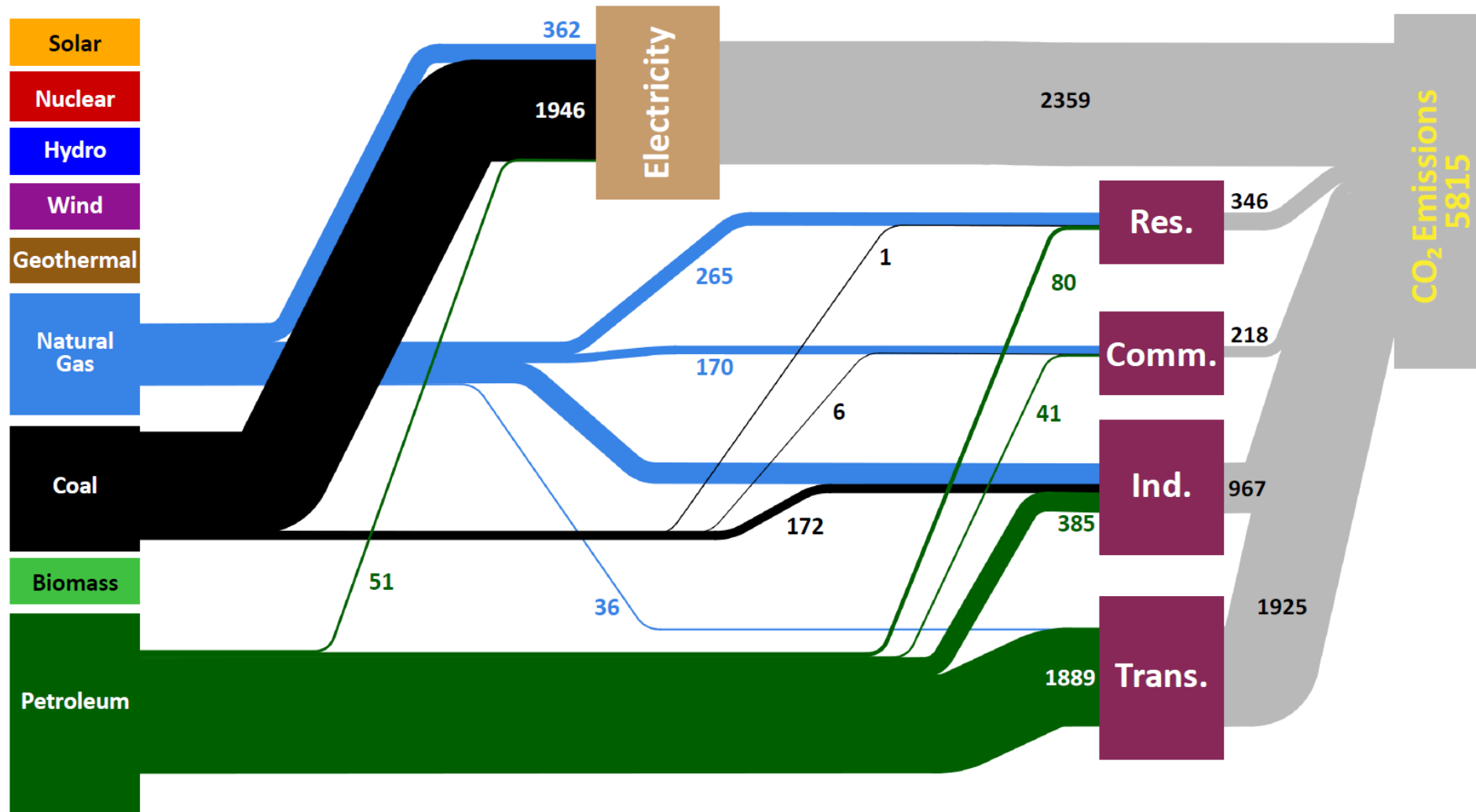

Source: Lawrence Livermore National Laboratory and the Department of Energy, Energy Information Administration, 2010 (based on data from DOE/EIA-0573(2008), December 2009).

# Major Changes are Required to Reduce Greenhouse Gas Pollution

To prevent global average surface temperature from rising more than 2.5 °C by 2050 . . .

. . . we must emit **less than 1000 GT** of CO<sub>2</sub> between 2000–2050 . . .

. . . but our emissions rate from 2000–2010 was **33 GT per year** . . .

. . . so we must reduce our emissions **by a factor of 8** between 2010-2050.



# Broad Expert Consensus on the Need for New Technologies

Scientific and technological advances will be required to make major changes to the energy system a “no brainer” for consumers and industry.

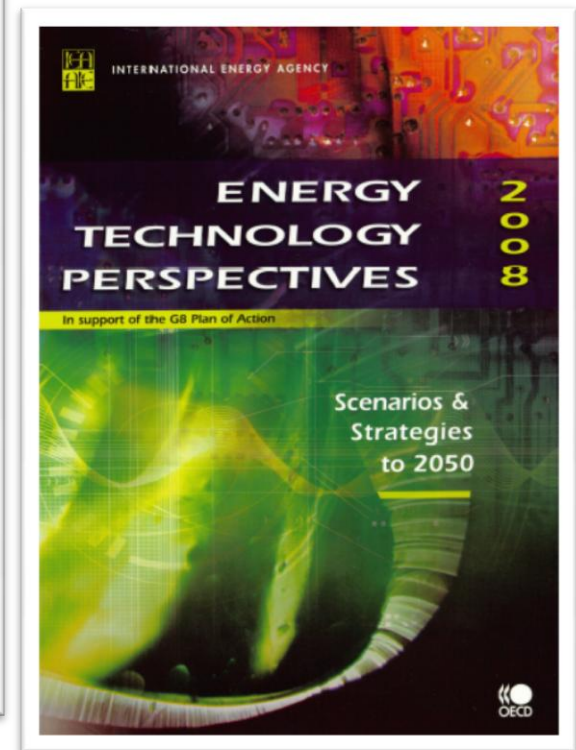
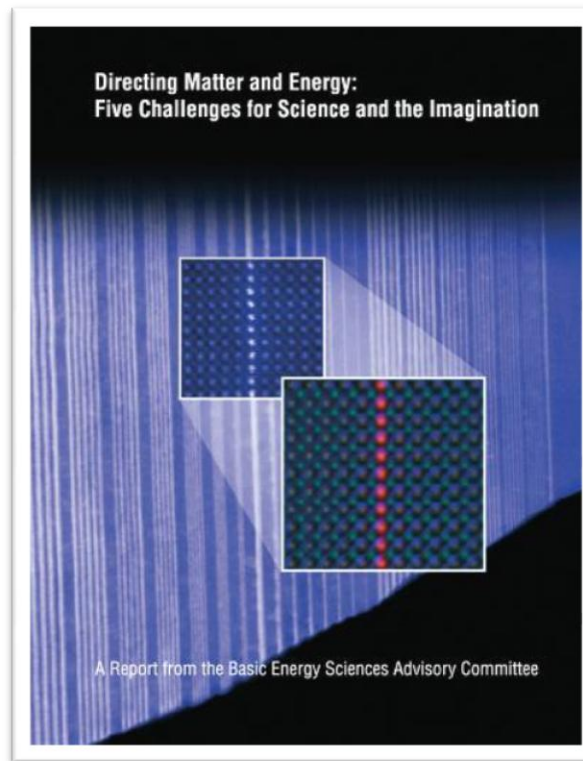
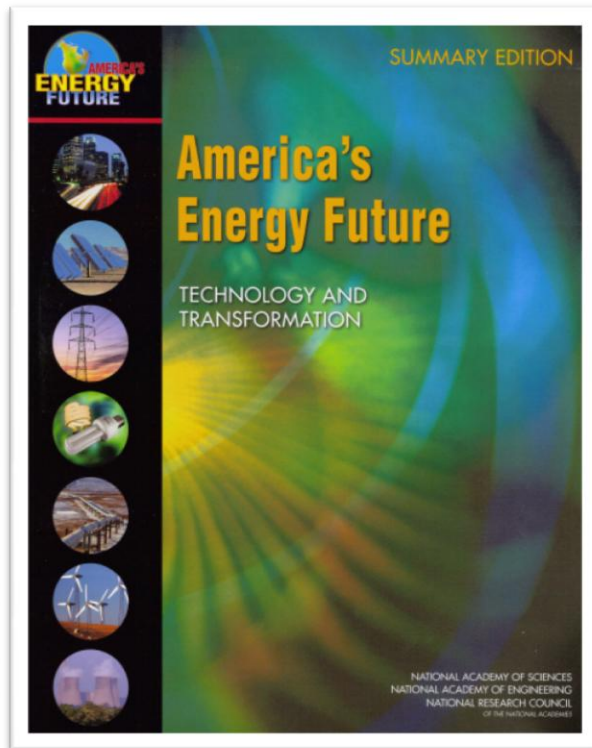

# A National Strategy for a New Energy Economy

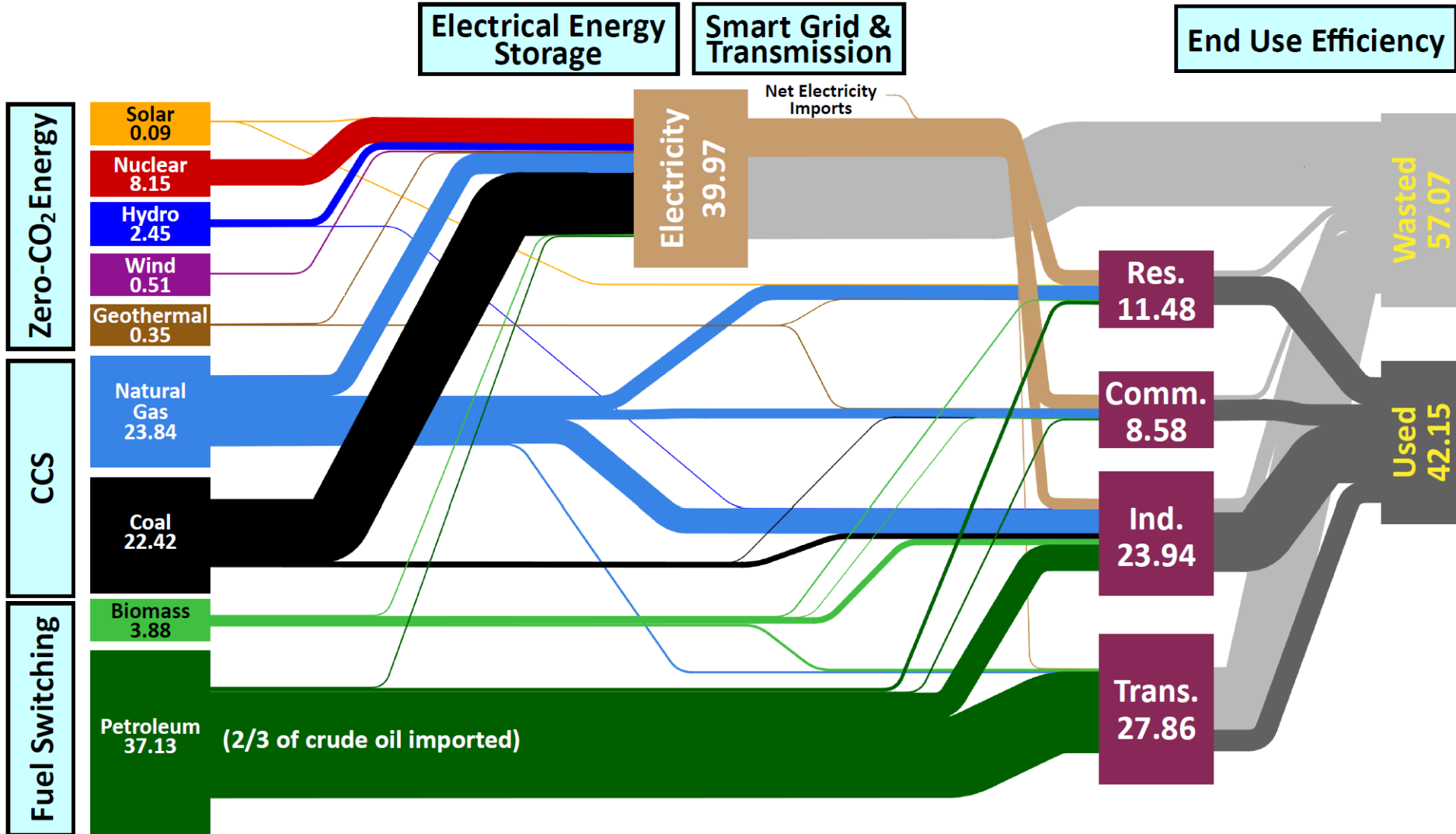

# Science for Zero Carbon Energy

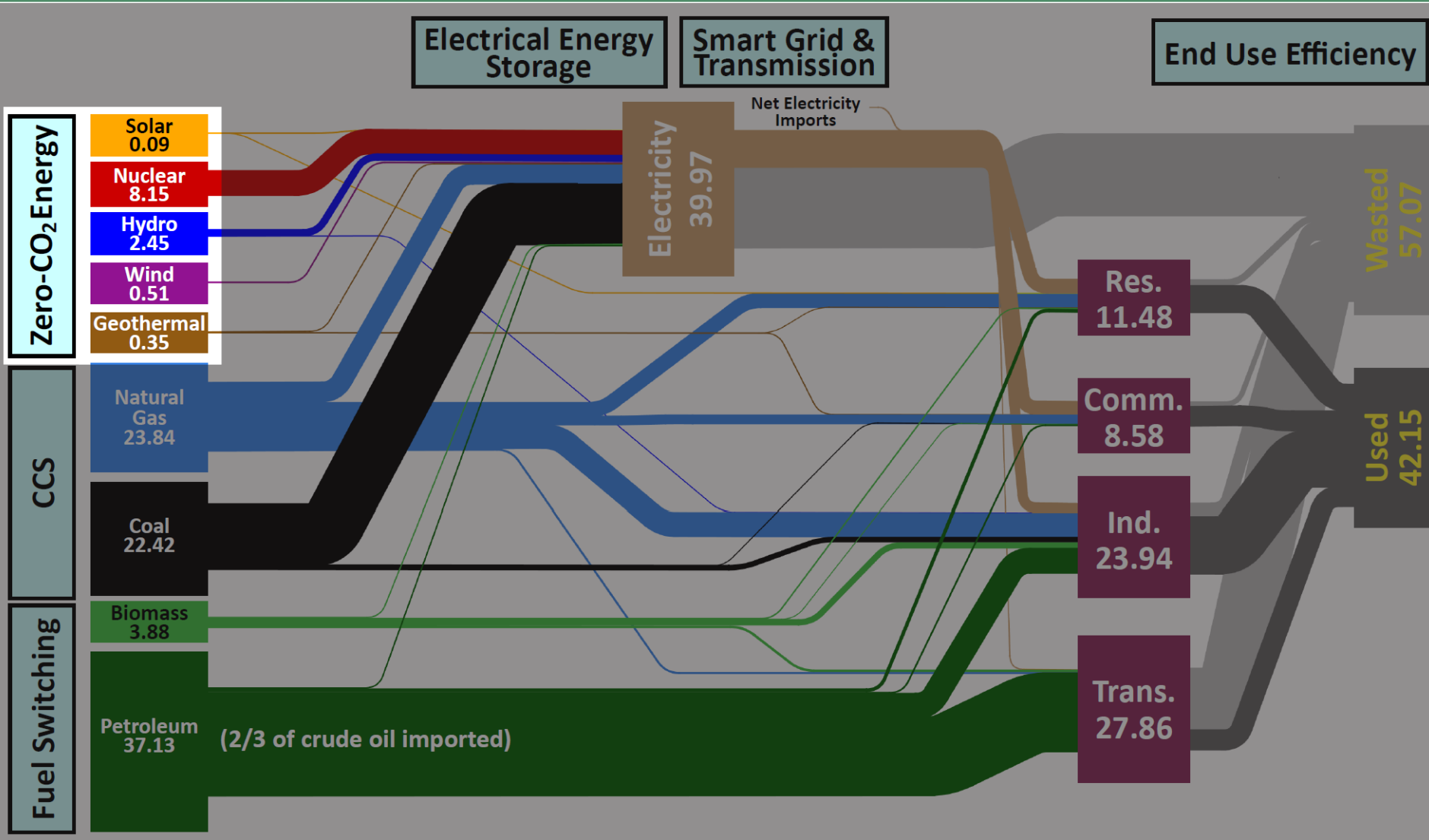



# Solar Photovoltaics



# Cost Competitiveness of Solar Energy is Improving

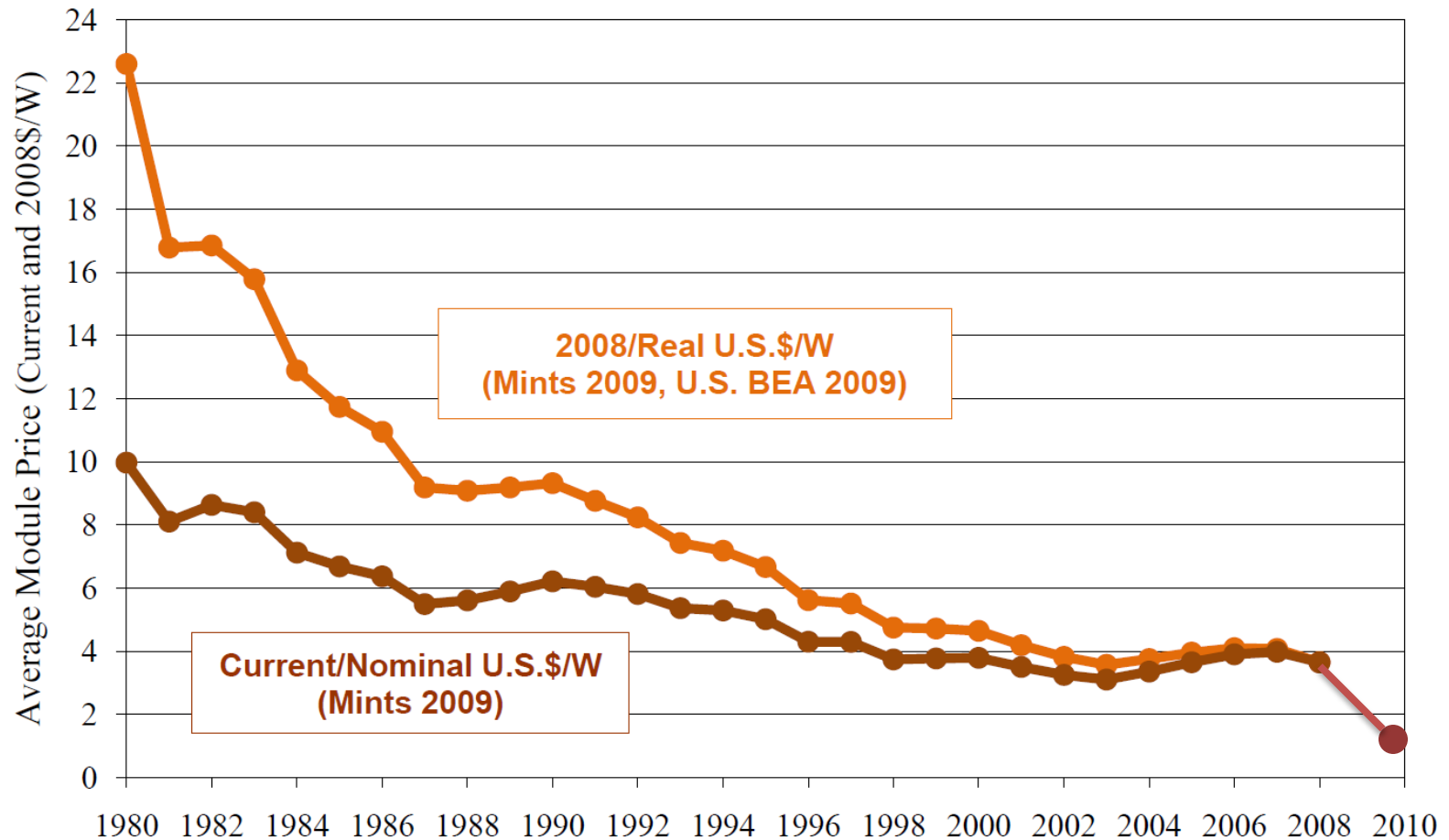

Source: Mints, P.; Tomlinson, D. (2008). *Photovoltaic Manufacturer Shipments & Competitive Analysis 2007/2008*. Report # NPS-Supply3. Palo Alto, CA: Navigant Consulting Photovoltaic Service Program and Mints, P. (2009). *Photovoltaic Manufacturer Shipments, Capacity, & Competitive Analysis 2008/2009*. Report # NPS-Supply4. Palo Alto, CA: Navigant Consulting Photovoltaic Service Program.

# Solar Photovoltaics: We Can Still Do Better

- **Technology Challenge:** Reduce costs and increase capacity for converting sunlight into electricity
- **Silicon:** Top commercial solar cells (single crystal silicon) have conversion efficiencies of ~18%; triple-junction cells with Fresnel lens concentrator technology are ~40%.
- **Science Challenges:** Cost-effective improvements in efficiency depend on understanding and controlling phenomena at the nanoscale.

# New Techniques for Improvement of PV Cell Efficiency

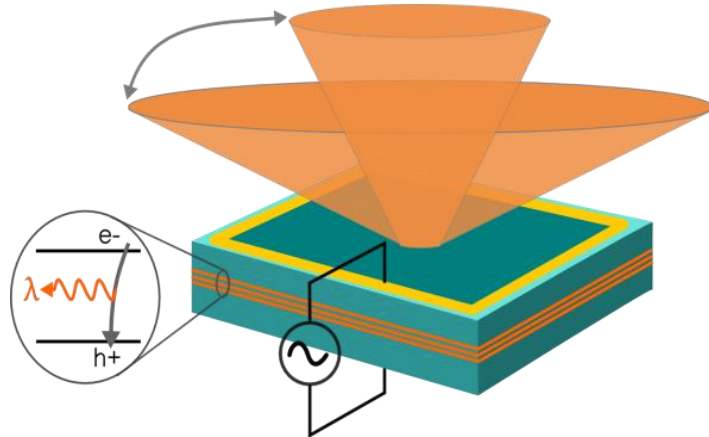

**Molding the flow of light: a novel photonic design for antireflection coatings for multiple wavelengths and light incident angles**

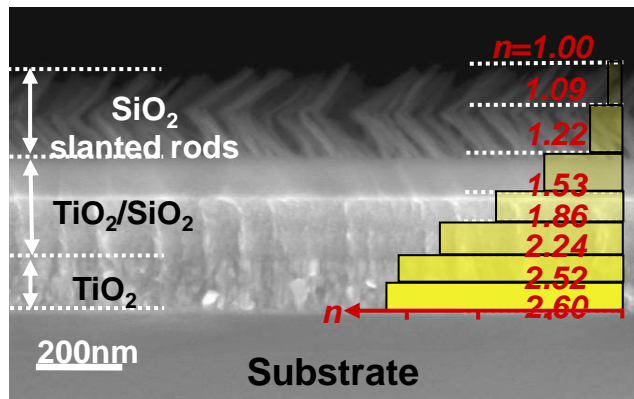

**SEM Image of a 7-layer graded anti-reflection coating structure**

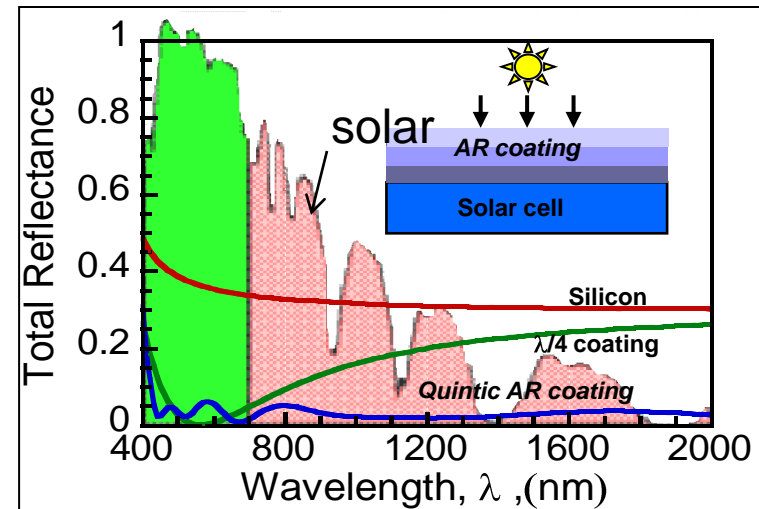

## Basic science breakthrough:

- A new architectural design for antireflection coating that solves, for the first time, both the multiple wavelength and incident light angles critical for efficient solar collection.
- The multi-layer nanostructure can produce a >20% solar efficiency enhancement and is universally applicable to many type of solar cells, including Si, III-V and organic cells.

Kuo and Lin et. al. *Optics Letters*, Nov. 2008



# Ultra High-Efficiency Solar Cells

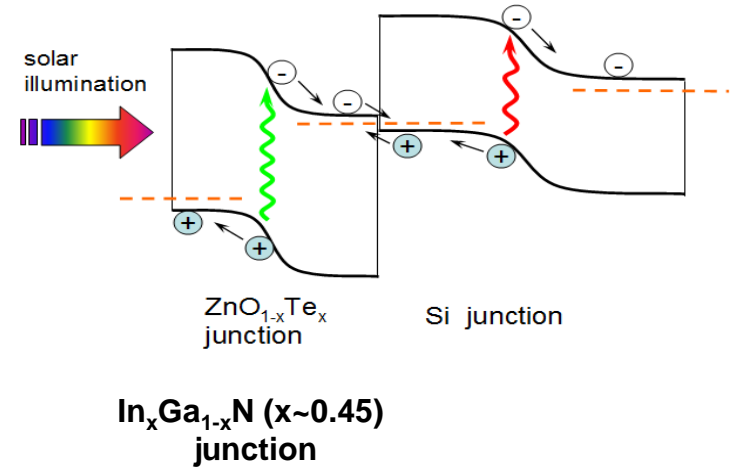
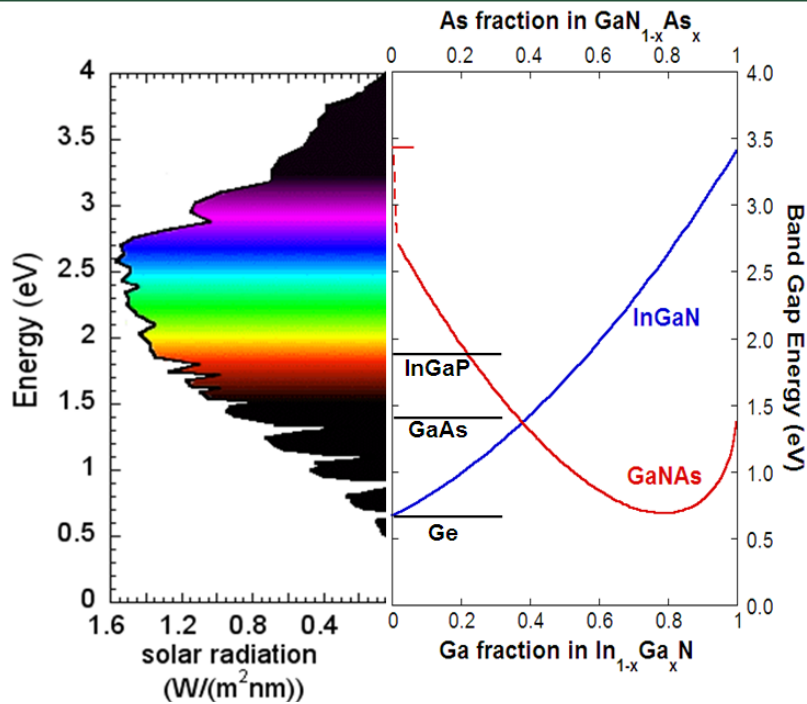

## Basic science breakthrough:

- Discovery of single alloy systems with wide band gap range: InGaN and GaNAs
- Low cost alternatives to conventional multi-junction cells

Ager et al., *Phys. Status Solidi C* **6**, S413 (2009). W. Walukiewicz et al., LBNL. Yu et al., *J. Appl. Phys.* **106**, 103709 (2009).



# Organic photovoltaics show promise for low cost flexible solar cells

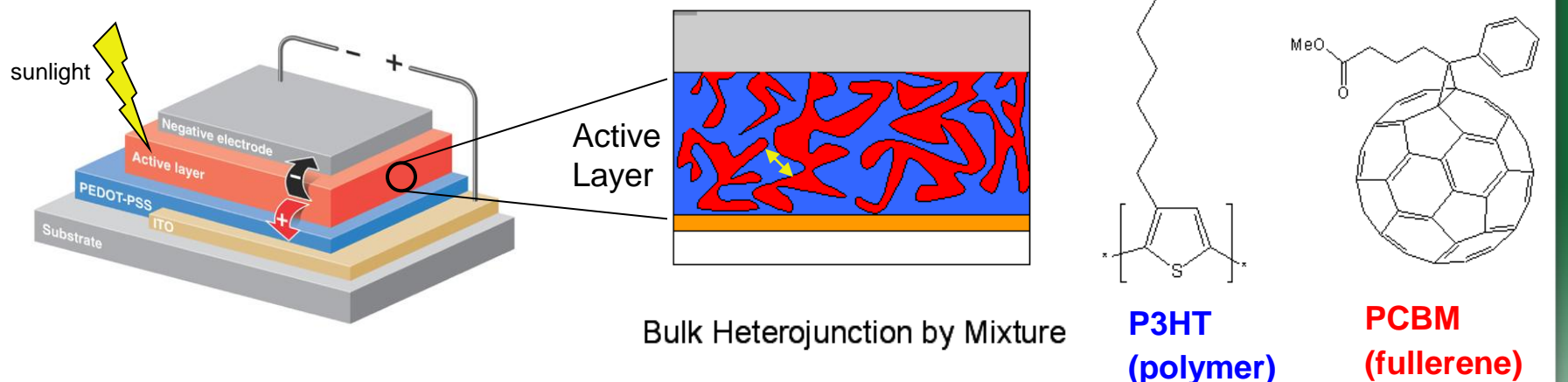

- For maximum efficiency, the polymer and fullerene (blue and red) must phase separate on 5-10 nm lengths, but so far this has been poorly characterized.
- Small angle x-ray scattering was used to **quantify** this morphology (plot at far right) including the average distance between polymer/fullerene interfaces & how this depends on solar cell processing
- X-ray diffraction was used to characterize polymer/fullerene molecular packing & how this affects solar cell performance
- These studies permit **rationale optimization** of solar cell processing and materials

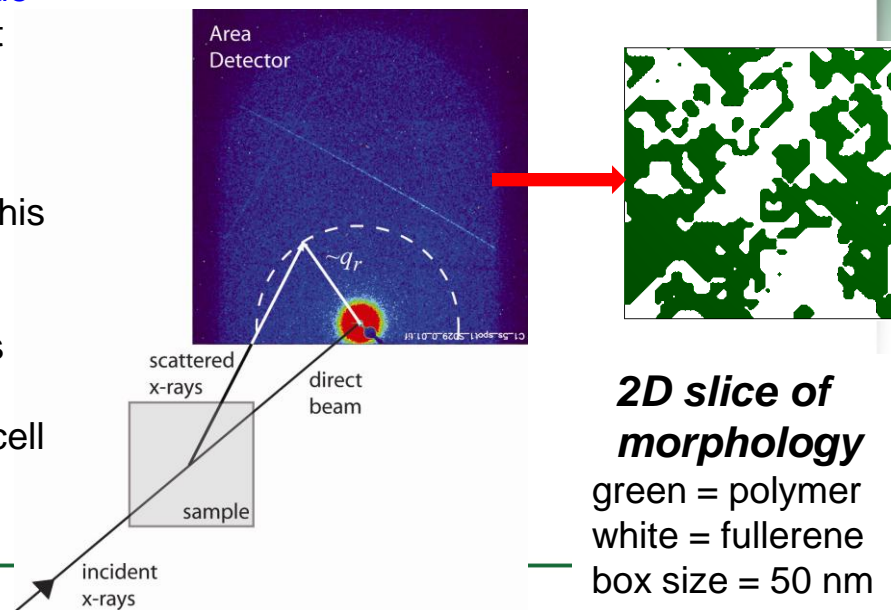

# Advanced Fission & Fusion Energy Systems



# Materials Science for Advanced Fission & Fusion Energy

Advanced fission and fusion reactors will operate at much higher temperatures than typical operating ranges of most materials today.

High temperatures are known to degrade strength over long time periods, especially when combined with other extreme conditions.

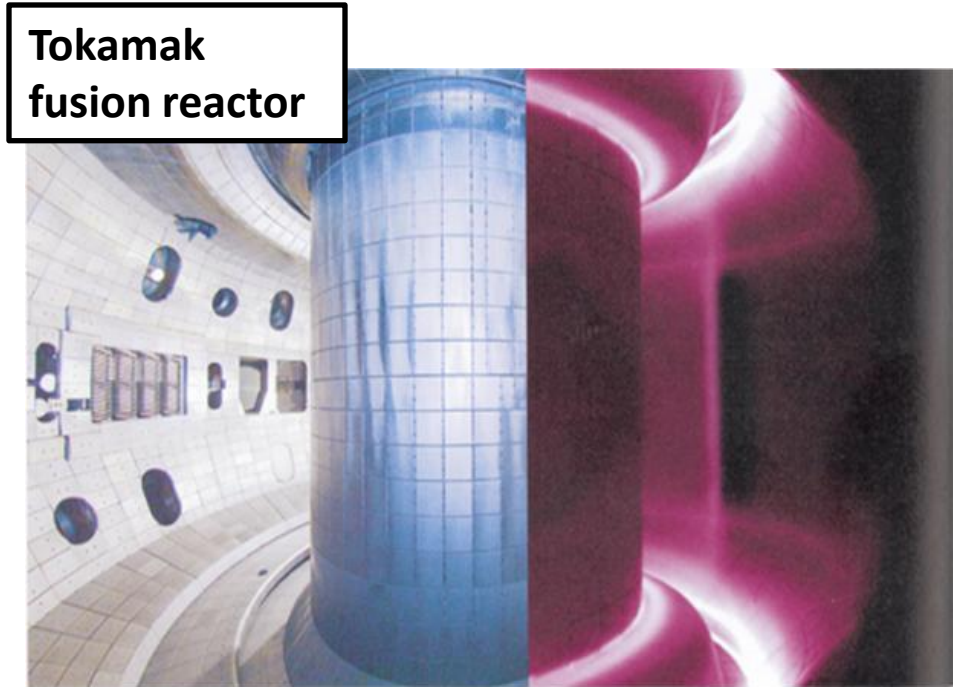
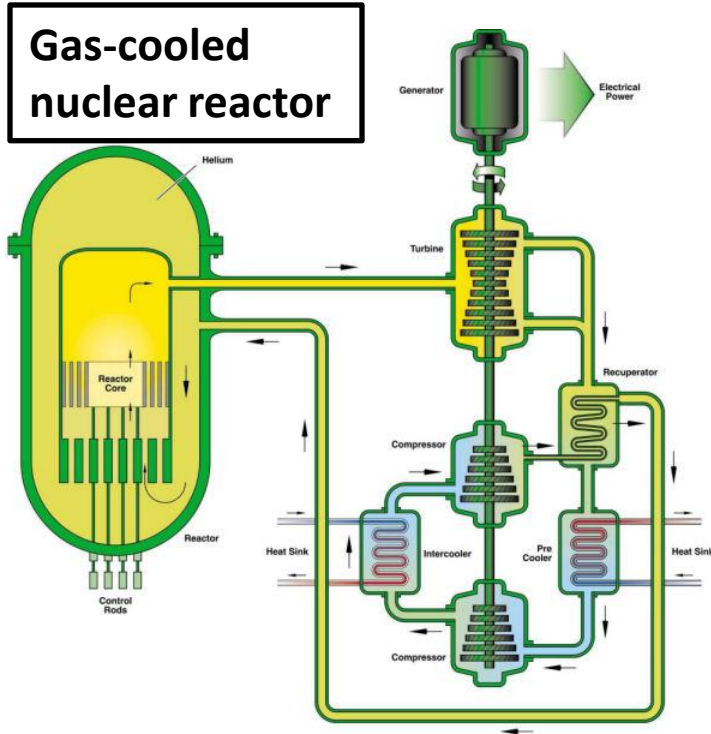



# Damage in Metals Due to Neutron Exposure

The neutrons emanating from fission and fusion reactions induce damage by disrupting the locations of atoms in the nearby materials.

Voids formed from clustering of vacancies lead to swelling in irradiated metals

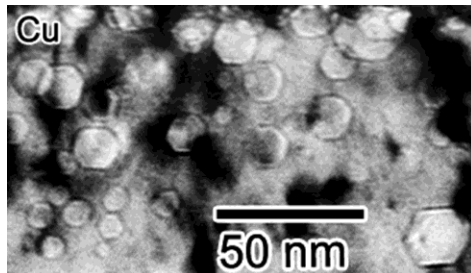

Materials have to be able to withstand fluences of 100 atomic displacements

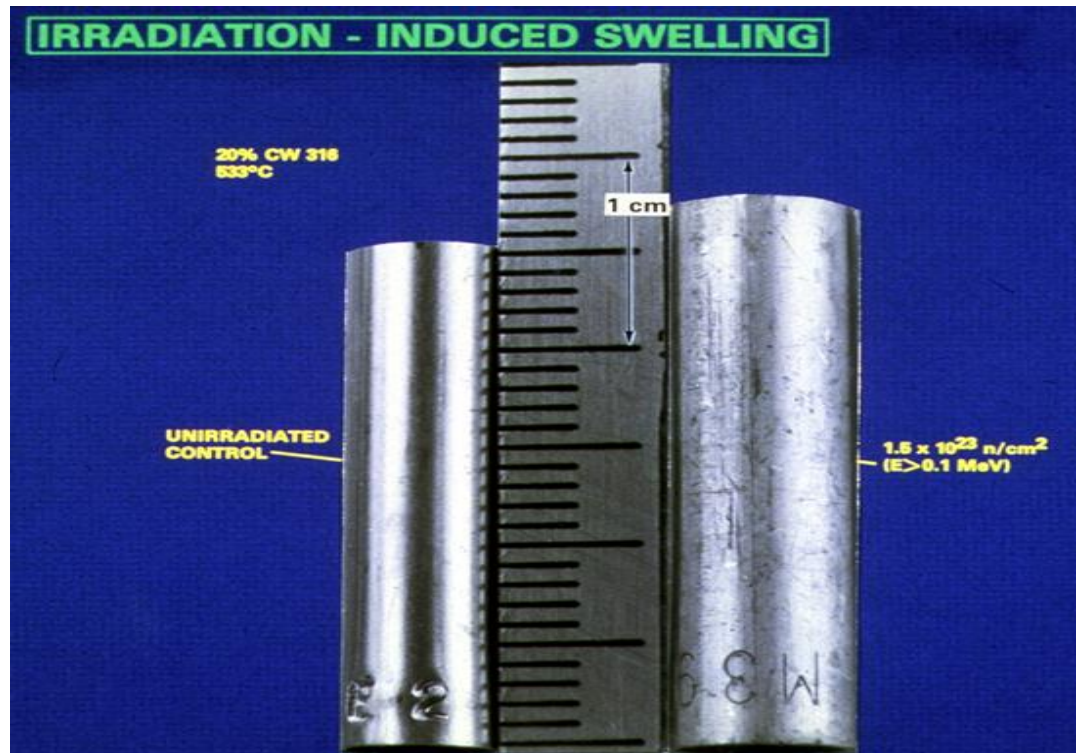

# New Radiation Resistant Materials

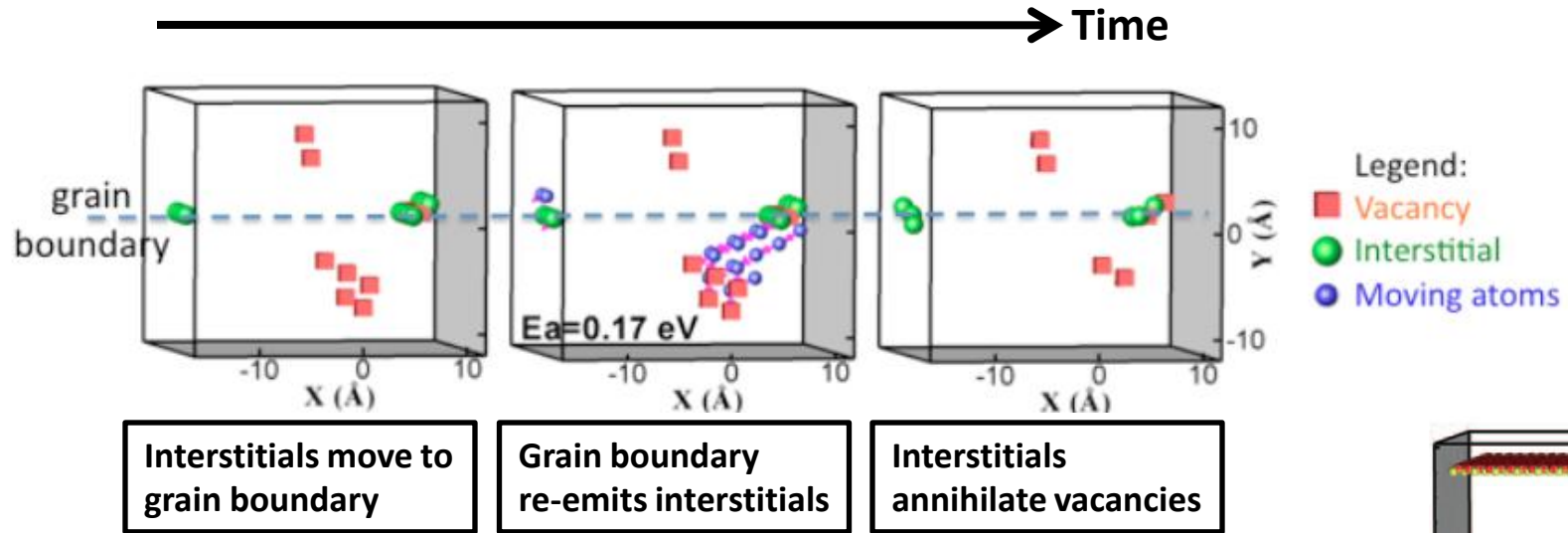

- A collision cascade displaces atoms, creating vacancies and interstitials (right, showing displaced atoms 0.5 ps after the cascade initiation).
- Fast-moving interstitials move quickly to a nearby boundary (above left). Slower-moving vacancies remain.
- A grain boundary loaded with interstitials emits them (above center)
- Nearby vacancies are annihilated (above right)
- This new mechanism may explain the enhanced radiation resistance observed in nanocrystalline materials with large numbers of grain boundaries.

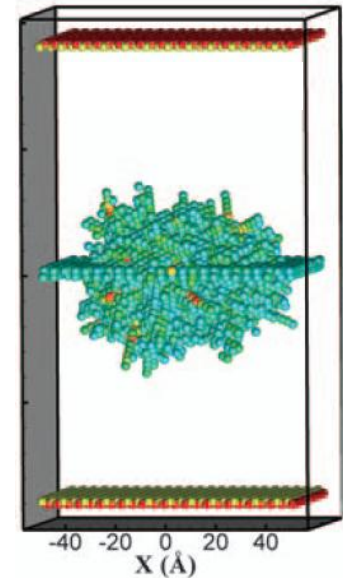

# Magnetic Fusion Energy: Controlling the Burning Plasma State

- **ITER will enable “burning plasmas”**

ITER, an international project being built in Cadarache, France, will create the world’s first sustained burning plasma fusion experiment.

- **Science challenge:**

Develop a robust and predictable approach to controlling the dynamics of this plasma state.

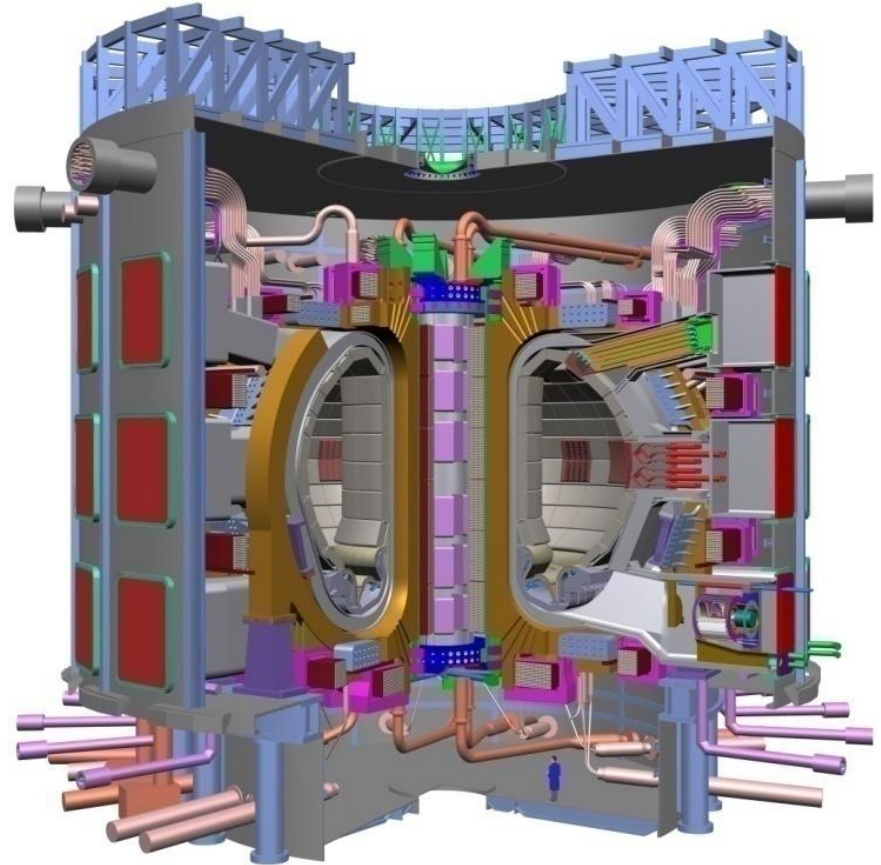

# Inertial Fusion Energy: Nearing Ignition

- The newly completed National Ignition Facility – the world’s most powerful laser system – recently began full operations
- NIF is on track to achieve the first laboratory demonstration of “ignition” or net energy gain

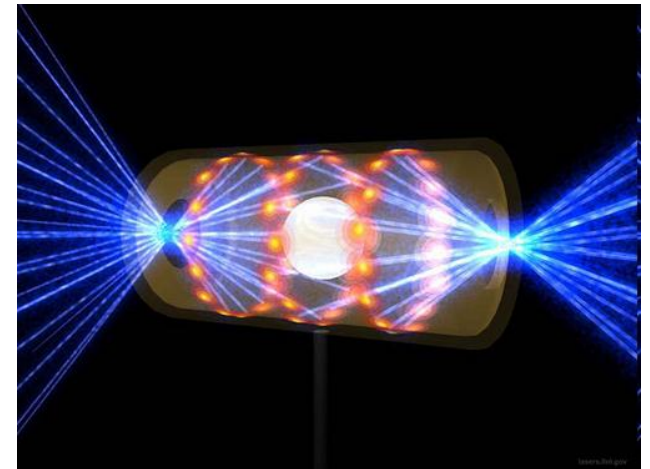

# Science for Carbon Capture and Sequestration

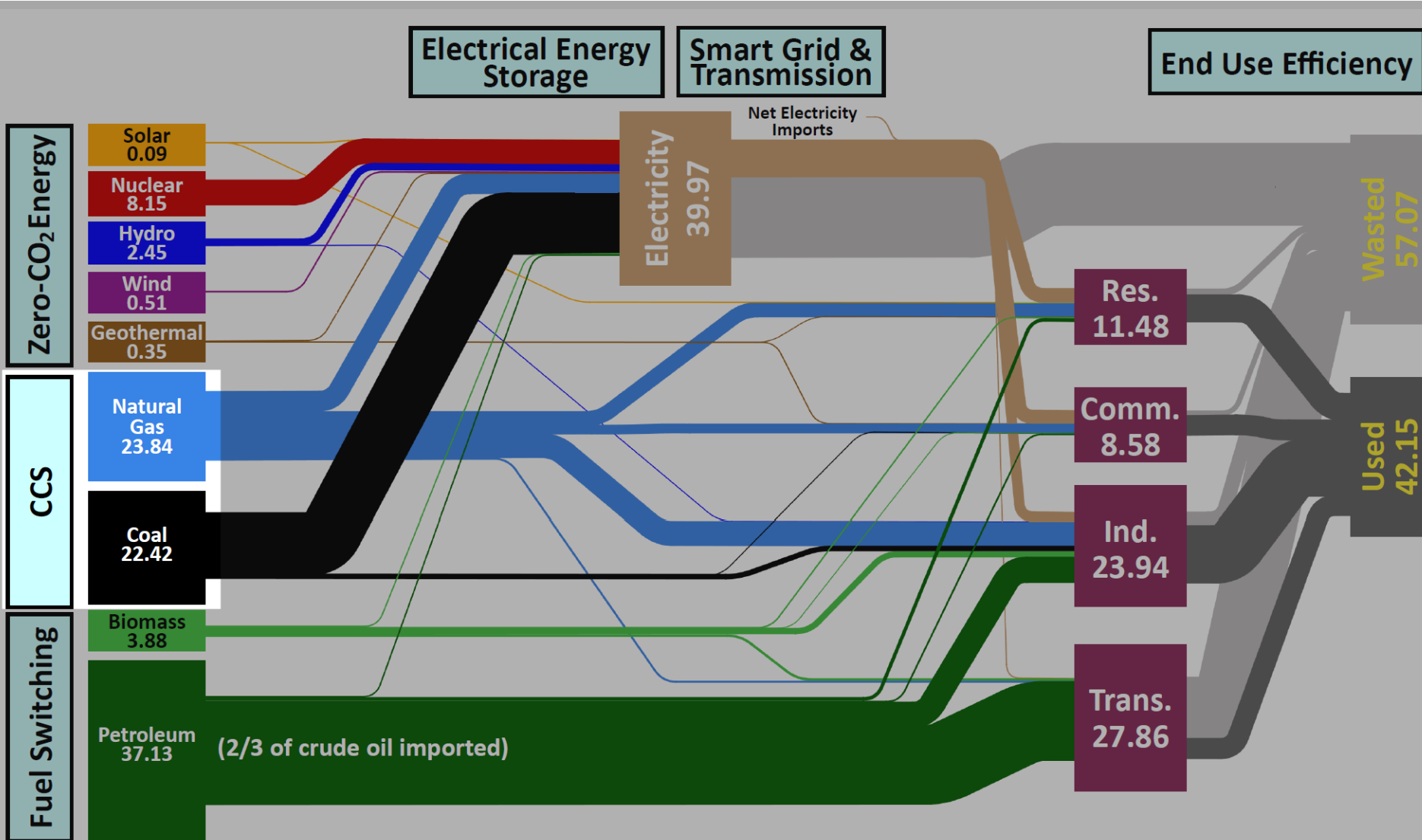

# Carbon Capture and Sequestration

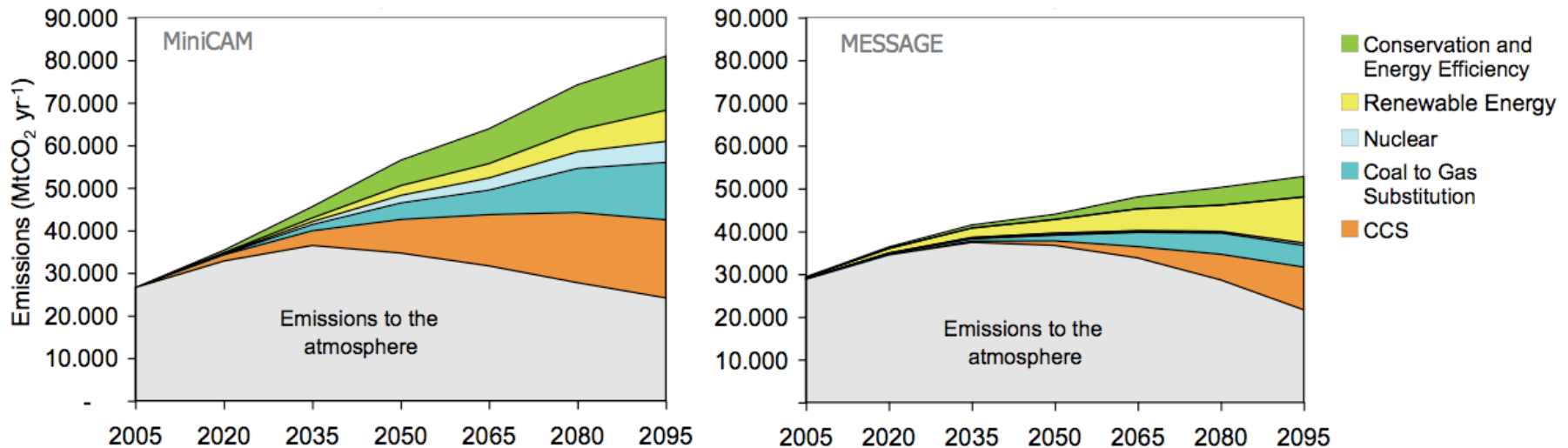

Two scenarios for reducing carbon dioxide emissions to keep atmospheric concentrations at 450-750 ppmv. Left: high-emission scenario, where nuclear plays an important role. Right: low-emission scenario. In both cases, carbon capture and storage (CCS) – the orange wedge – plays a critical role. (IPCC report, 2007)

- **Continued use of fossil fuel while capping the atmospheric concentration of carbon dioxide to about double the pre-industrial level requires the sequestration of ~10 GT of CO<sub>2</sub> per year.**
- **Current technologies for the post-combustion capture of CO<sub>2</sub> are too expensive.**
- **“Underground” as a long-term storage container**
  - **Advantages:** Enormous volume; distance from subsurface environment; pre-made container
  - **Disadvantages:** Designed by nature, only approximately fits the design criteria for containment; complex materials and processes; difficult to see and monitor; uncertainty about long-term performance



# Today's Carbon Capture Options

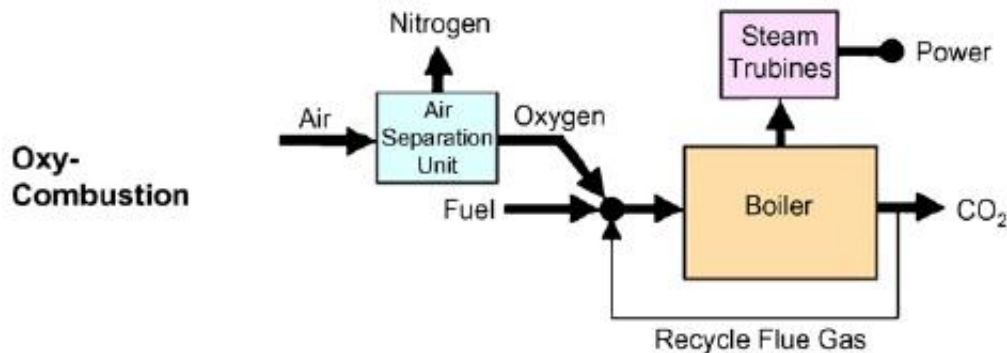
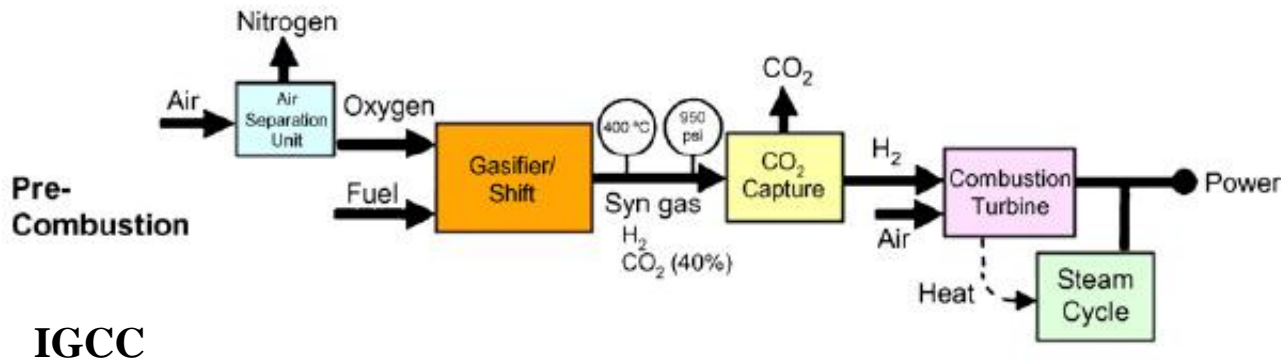
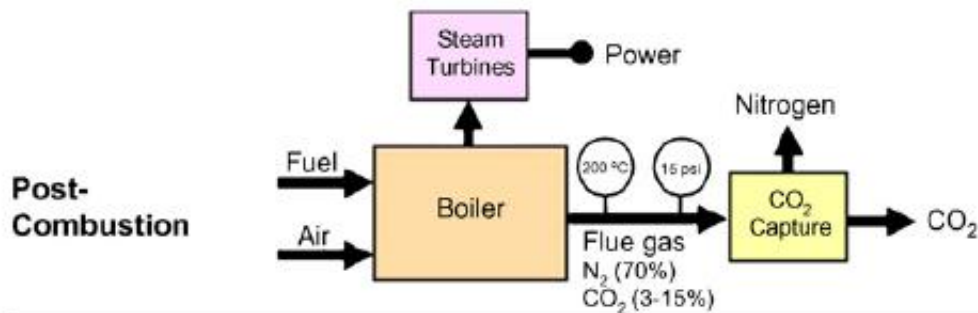

## Challenges

- Low CO<sub>2</sub> Concentration
- High energy for regeneration
- Mostly new plants
- Oxygen production – Air Separation Units (ASUs) have high electricity cost (chemical looping, ITMs)
- ASUs consume considerable energy
- Expense - corrosion resistant materials



# New Materials May Aid in Capturing Carbon Dioxide

**Metal-organic frameworks (MOFs) act as “crystalline sponges” and show promise at reducing the energy penalty for CO<sub>2</sub> capture.**

**A new magnesium-based MOF is selective in capturing CO<sub>2</sub> in the presence of CH<sub>4</sub> and releases the stored CO<sub>2</sub> at temperatures much lower than current capture media.**

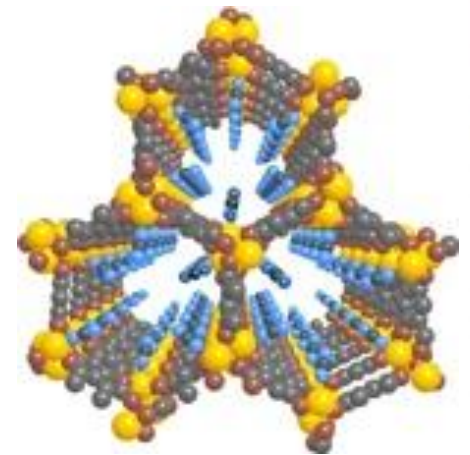
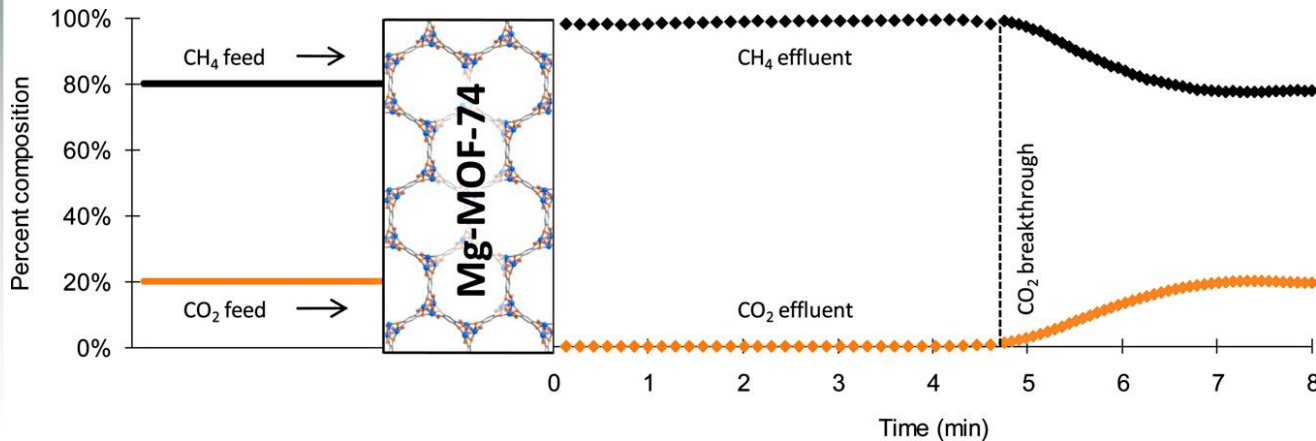

Schematic structure of Mg-MOF-74

*D. Britt, H. Furukawa, B. Wang, and O. M. Yaghi, PNAS 106, 20637 (2009); also see N.Y. Times on Dec. 8, 2009.*





# Geological CO<sub>2</sub> Sequestration

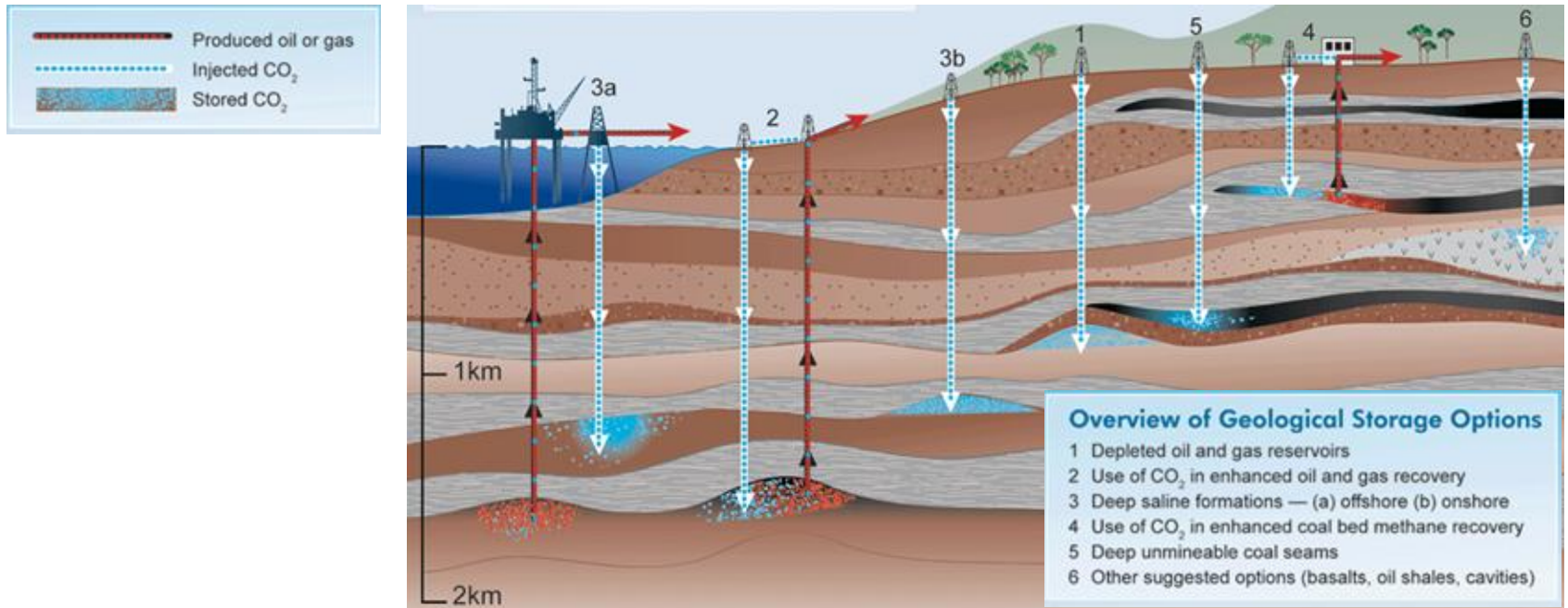

Prediction of CO<sub>2</sub> Sequestration effectiveness depends on understanding:

- Reactive fluid flow properties of multiphase fluids under reservoir conditions in porous and fractured media
- Geochemical stability of mineral phases within deep formations
- Improved geophysical imaging of reservoir-scale properties to track changing reservoir dynamics over long periods of time



# Energy Frontier Research Center: Center for Frontiers of Subsurface Energy Security (Gary Pope, UT- Austin)

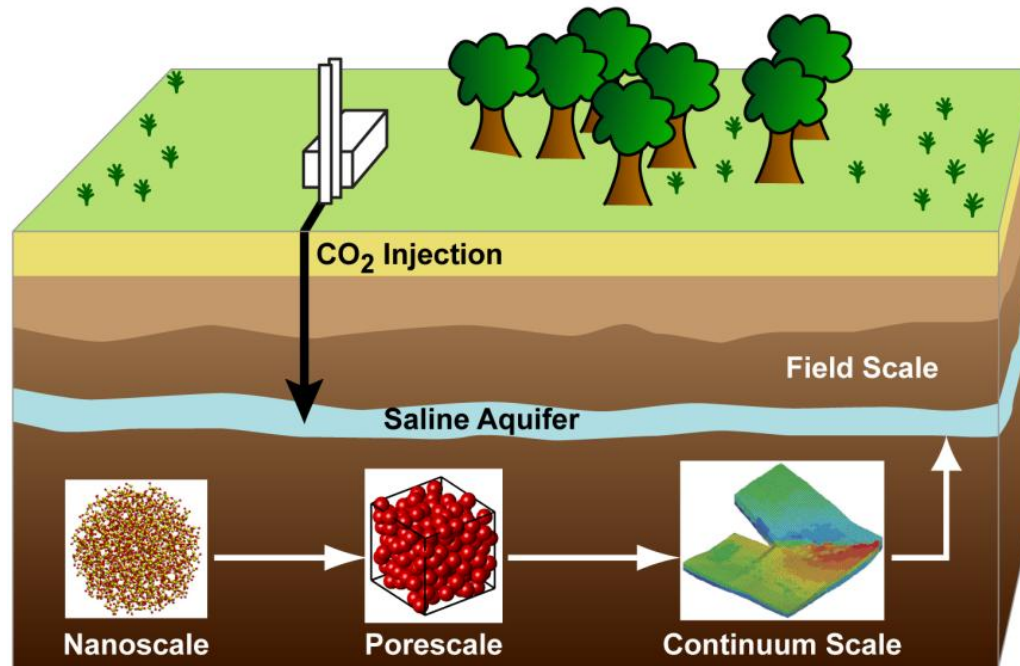

## RESEARCH OBJECTIVES:

Development of scientific understanding of subsurface physical, chemical and biological processes from very small to very large scale so that we can predict the behavior of CO<sub>2</sub> and other byproducts of energy production stored in the subsurface.



# Energy Frontier Research Center: Nanoscale Controls on Geologic CO<sub>2</sub> (Donald DePaolo, LBNL)

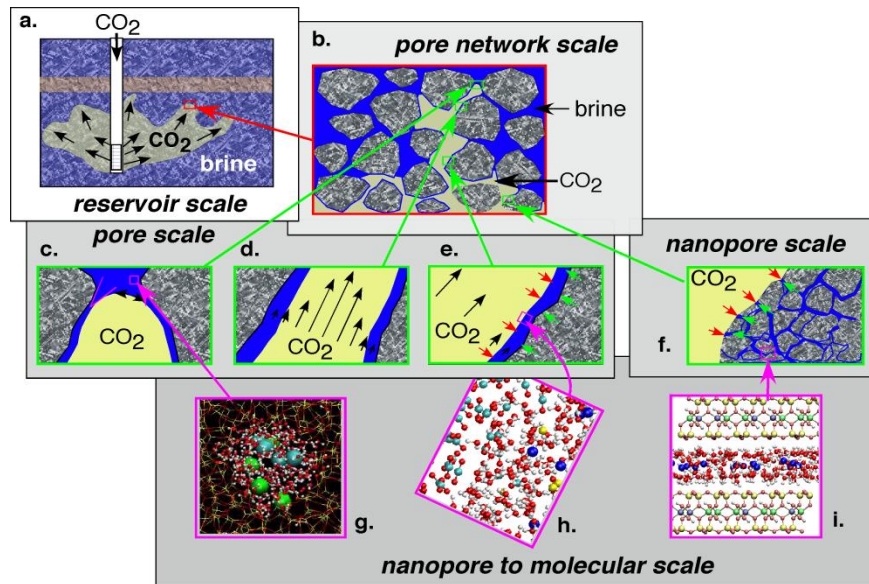

## RESEARCH OBJECTIVES:

- (1) Development of molecular, nano-scale, and pore network scale approaches for controlling flow, dissolution, and precipitation in subsurface rock formations during emplacement of supercritical CO<sub>2</sub>; and
- (2) Achievement of a new level of prediction of long-term performance



U.S. DEPARTMENT OF  
**ENERGY**

Office of  
Science



UC DAVIS  
PETER A. ROCK  
Thermochemistry  
Laboratory



OAK RIDGE NATIONAL LABORATORY  
Managed by UT-Battelle for the Department of Energy

# Science for Transportation Fuel Switching

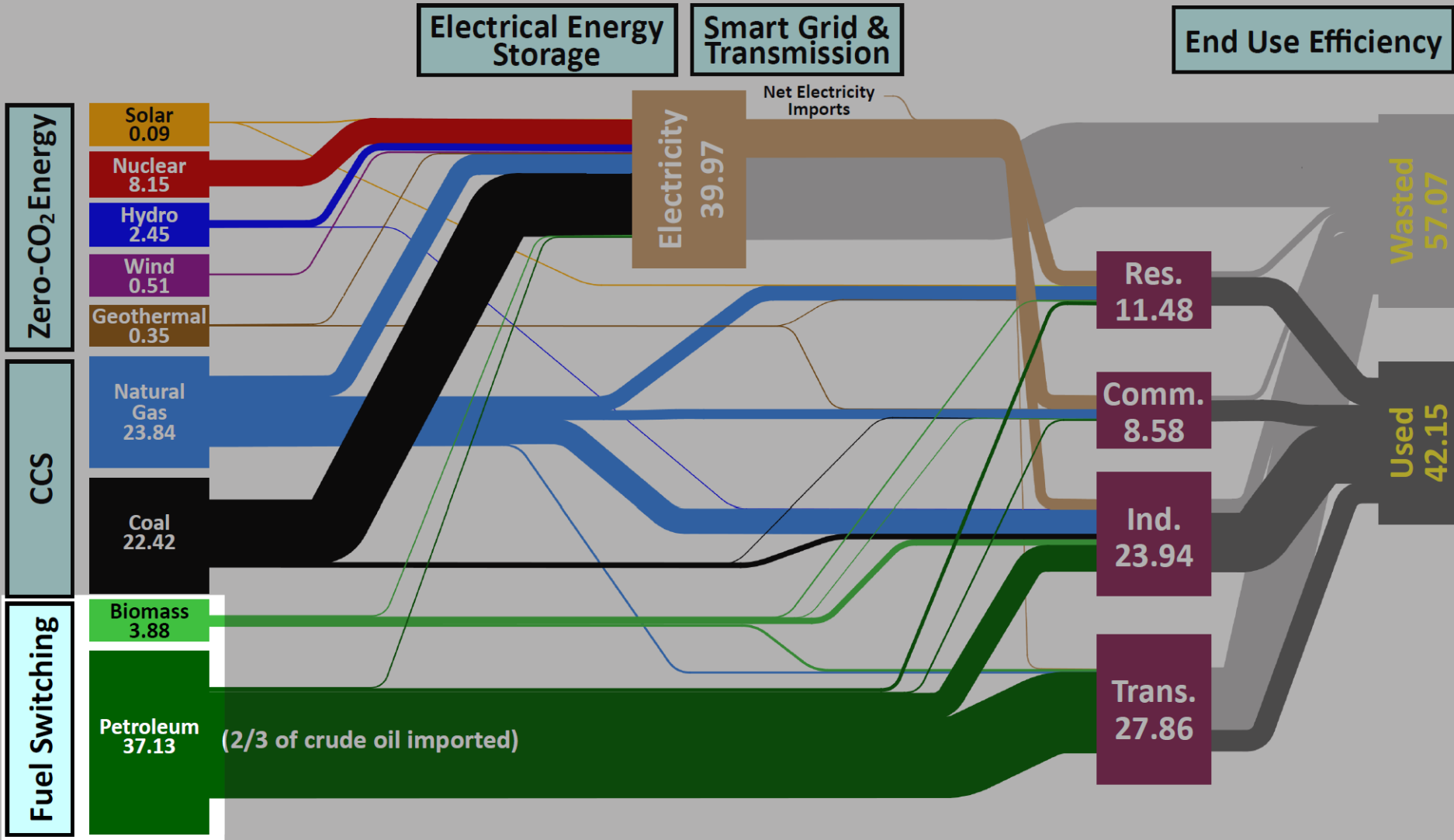

# The DOE Bioenergy Research Centers

## Revolutionizing discovery of biofuels solutions

- **New paradigm for research—single focus, multi-disciplinary, highly integrated science**
- **Building on DOE's investments in user facilities and fundamental research programs**
- **Focus on**
  - **Feedstock characterization & development**
  - **Feedstock deconstruction**
  - **Feedstock conversion to liquid fuels**



# Oxidation of methane by a biological dicopper center

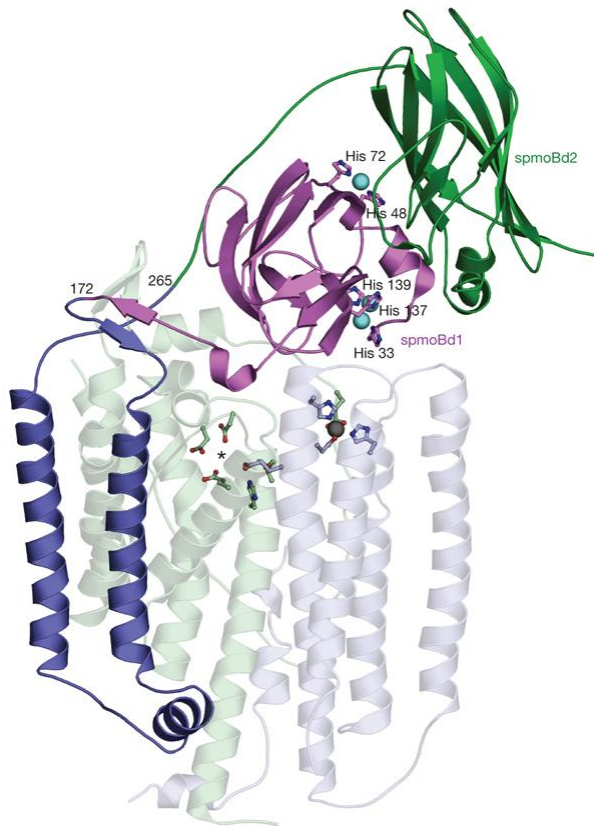

Structure of copper active site of methane oxidation enzyme

- Chemical production of liquid fuels can not efficiently use methane gas available in nature
  - Conventional methods to convert methane to methanol require too much energy to be practical
- Bacteria can convert methane under ambient conditions using metalloenzymes
  - Methane monooxygenases (MMOs) are optimal models for efficient environmentally sound catalyst
  - Active copper site previously unknown
- This work using crystallography and XAS discovered that the active site is a dicopper center in a soluble domain of the protein
  - Provides new approaches to environmentally friendly methane oxidation catalysts

# Prospects for Solar Fuels Production

## What We Can Do Today

\$12/kg H<sub>2</sub> @ \$3/pW PV  
(BRN on SEU 2005)

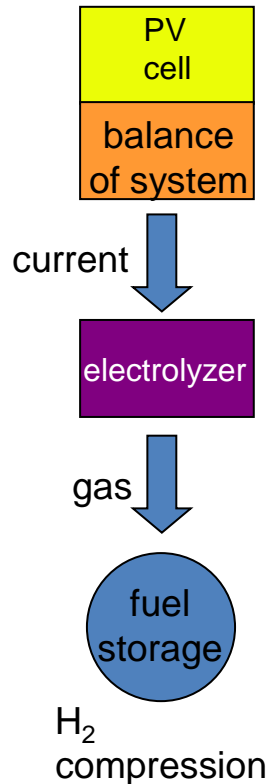

High capital costs

We do not know how to produce solar fuels in a cost effective manner.

## Two Limits

Low capital costs

Chemists do not yet know how to photoproduce O<sub>2</sub>, H<sub>2</sub>, reduce CO<sub>2</sub>, or oxidize H<sub>2</sub>O on the scale we need.

## Ultimate Goal

solar microcatalytic energy conversion

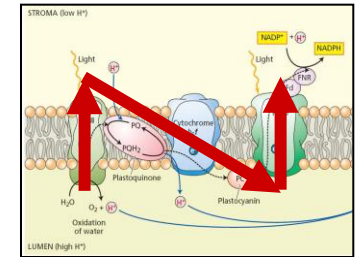

liquid

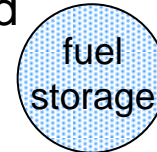

gas

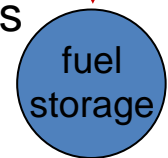

compression



# Science for Electrical Energy Storage

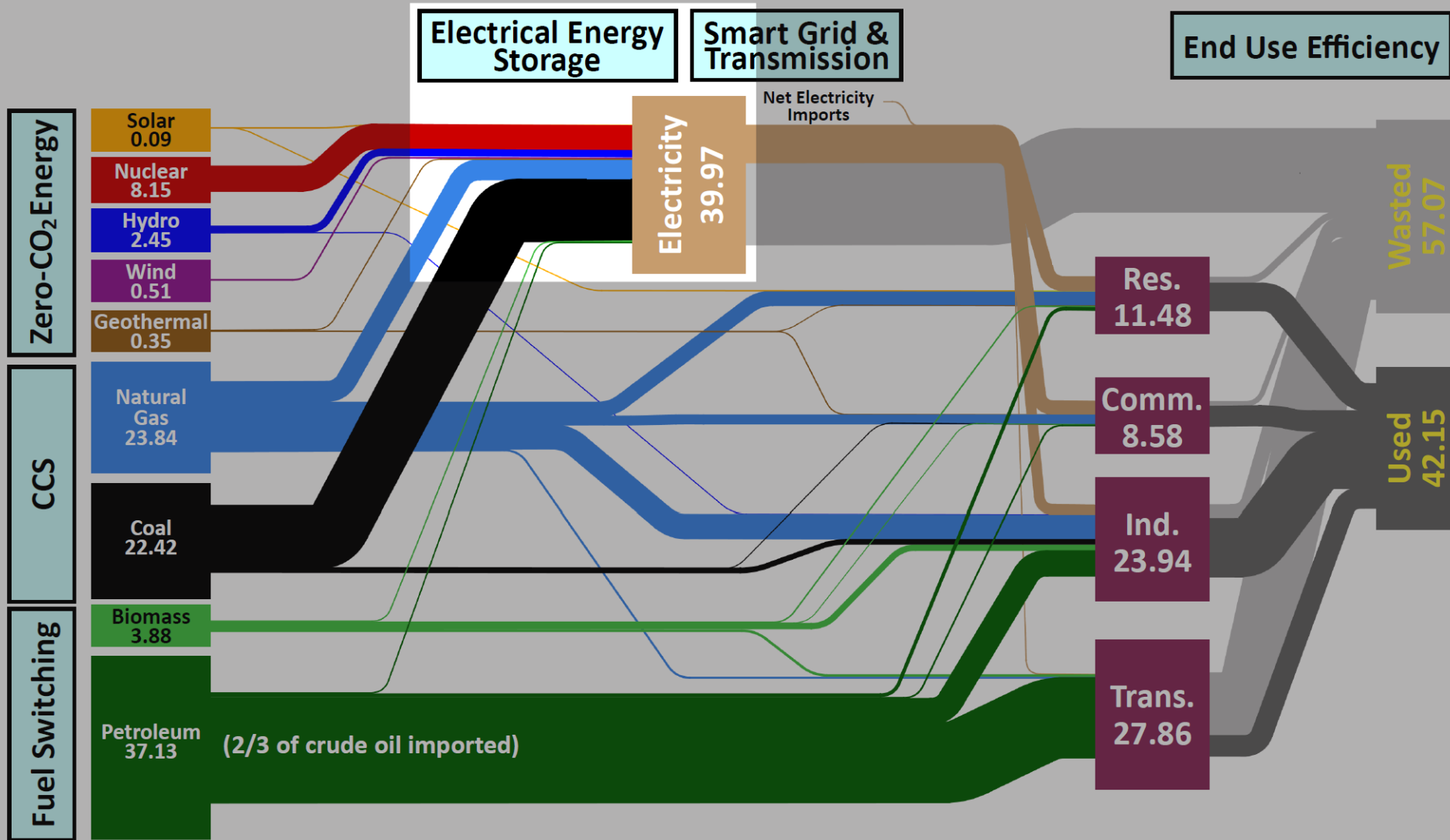



# Basics: Energy Storage Time Scales

## Seconds to Minutes

### Regulation

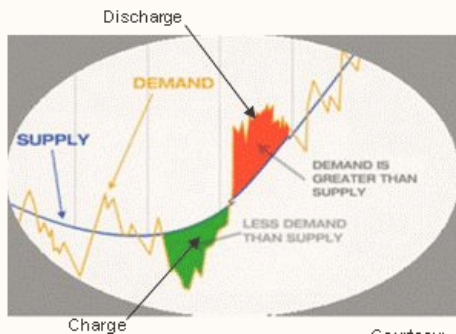

## Minutes - One Hour

### Ramping

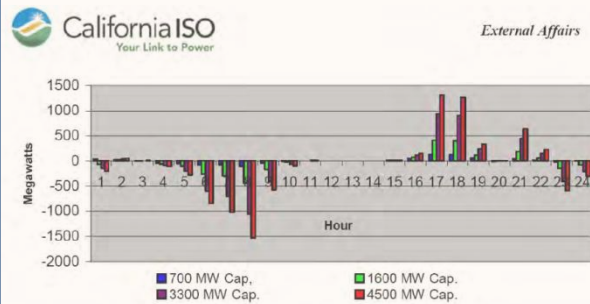

## Several Hours - One Day

### Peak shaving, load leveling

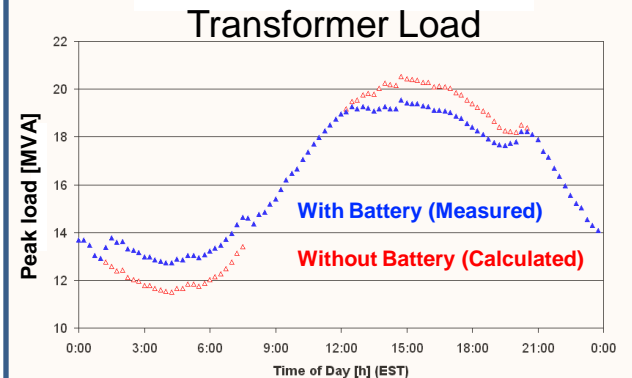

While different time regimes will require different storage solutions, there are many common science questions.

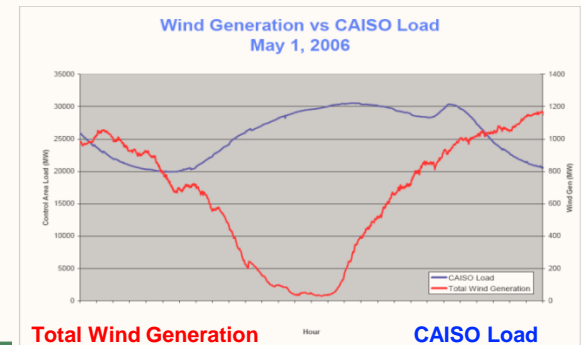
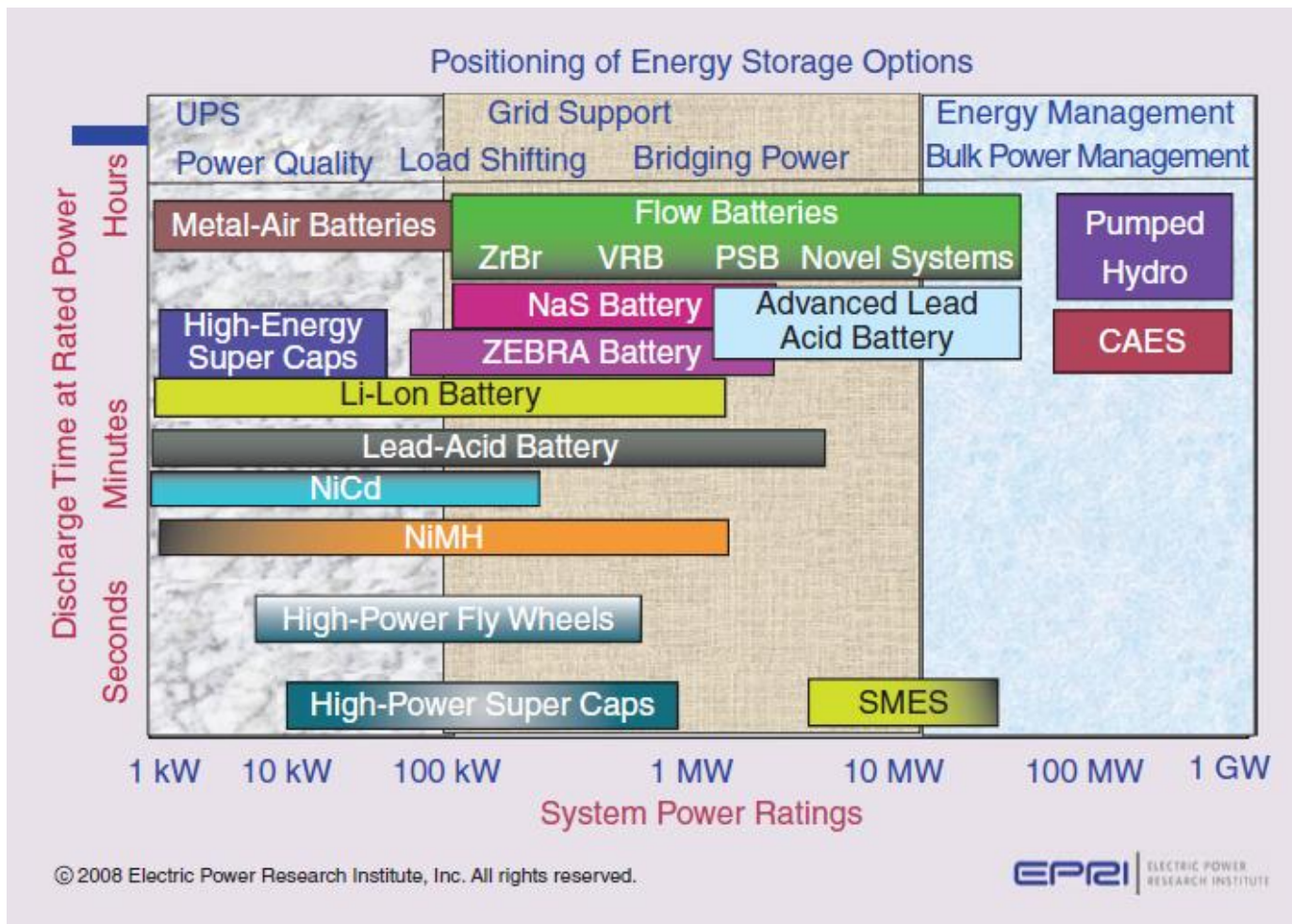

Figure 11: Total Wind vs. CAISO Load



# Current Battery and Energy Storage Technologies



# Pt-Cu Catalysts for Polymer Electrolyte Membrane Fuel Cells (PEMFC)

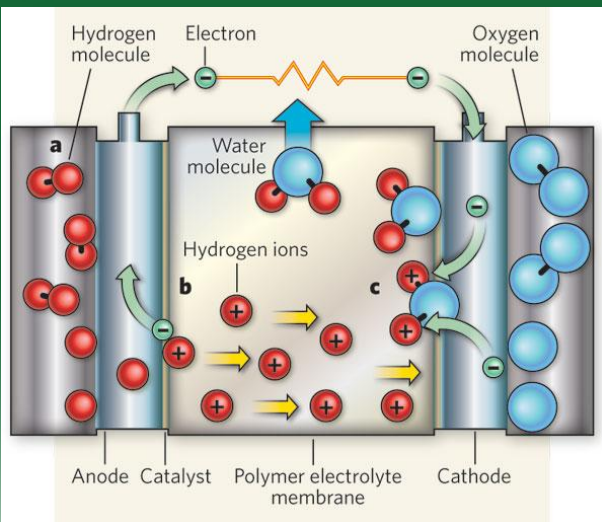

## PEMFCs limitations:

- Pt catalyst in cathode is inefficient & expensive
- Dealloyed  $\text{Cu}_3\text{Pt}$  nanoparticle catalysts are more active & use less Pt

## $\text{Cu}_3\text{Pt}$ catalysts: Pt mass based activity

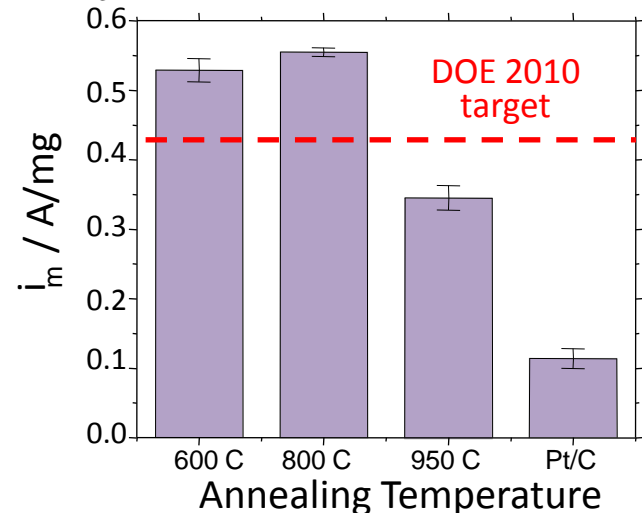

## X-ray studies show:

- Dealloyed  $\text{Cu}_3\text{Pt}$  nanoparticle catalyst forms **core-shell** structure with Pt rich shell
- The Pt shell is **compressively strained** & this results in higher catalytic activity
- Dynamics of dealloying and stability studied *in-situ* with X-rays
- $\text{Cu}_3\text{Pt}$  catalysts are **nearly as stable** as pure Pt

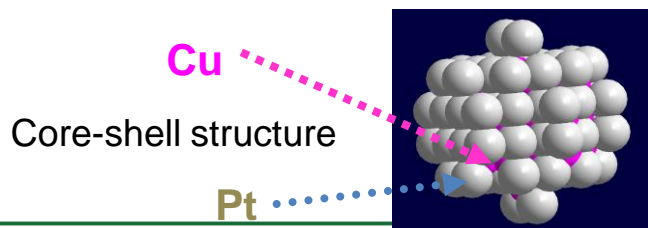

## In-situ X-ray cell

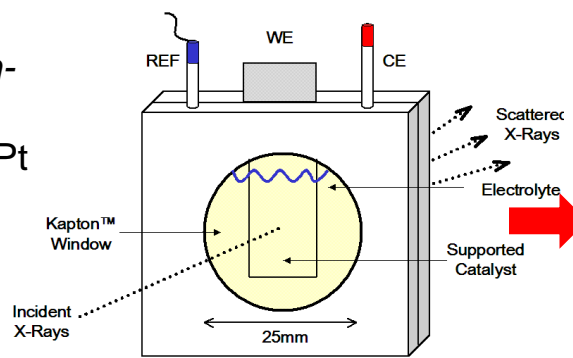

## Diffraction: SSRL BL11-3

