



# A Magnetized Electron Source for Ion Beam Cooling

## DoE Phase II SBIR

Joseph Conway, Bruce Dunham, Ralf Eichhorn, Colwyn Gulliford,  
Val Kostroun (PI), Christopher Mayes, Karl Smolenski, Nicholas Taylor

---



# Outline

---

- Company Overview
  - Need for magnetized beams
  - Phase I: Injector design
  - Phase II Design
    - Beam physics
    - Electrostatic
    - RF
    - Mechanical
  - Phase II Fabrication Schedule
  - Summary
-



# Company Overview

---

- Formed in 2013 by 5 partners – 150+ years of accelerator design expertise
  - Most of Xelera were from the Cornell ERL development team, who designed and built the world's highest current, high brightness photoinjector, which is being used now in the 4-pass ERL: CBETA
  - Now at 9 total employees
  - Focus Areas:
    - Accelerator design (EIC magnetized injector design)
    - Radiation physics consulting (ASU BioDesign C safety systems design)
    - Electron source design and fabrication (JLEIC Cooler Magnetized Gun)
-



## EIC need for magnetized beam

---

- Electron cooling of the ion beam is a critical aspect of a successful electron-ion collider (EIC), possibly improving the luminosity by a factor of 5
  - A (pre)magnetized beam becomes still in the cooling solenoid. This is done by immersing the cathode in a solenoid field.
  - Photoguns are highly flexible and offer control over the phase space of the bunch, but have not been proven continuously at very high currents
  - A Thermionic gun could be a viable (low risk) plan B
  - Xelera is building a prototype Thermionic Gun (Tgun), to be tested at Jlab's Gun Test Stand (GTS) in November.
-

# Magnetized Beams for EIC cooling

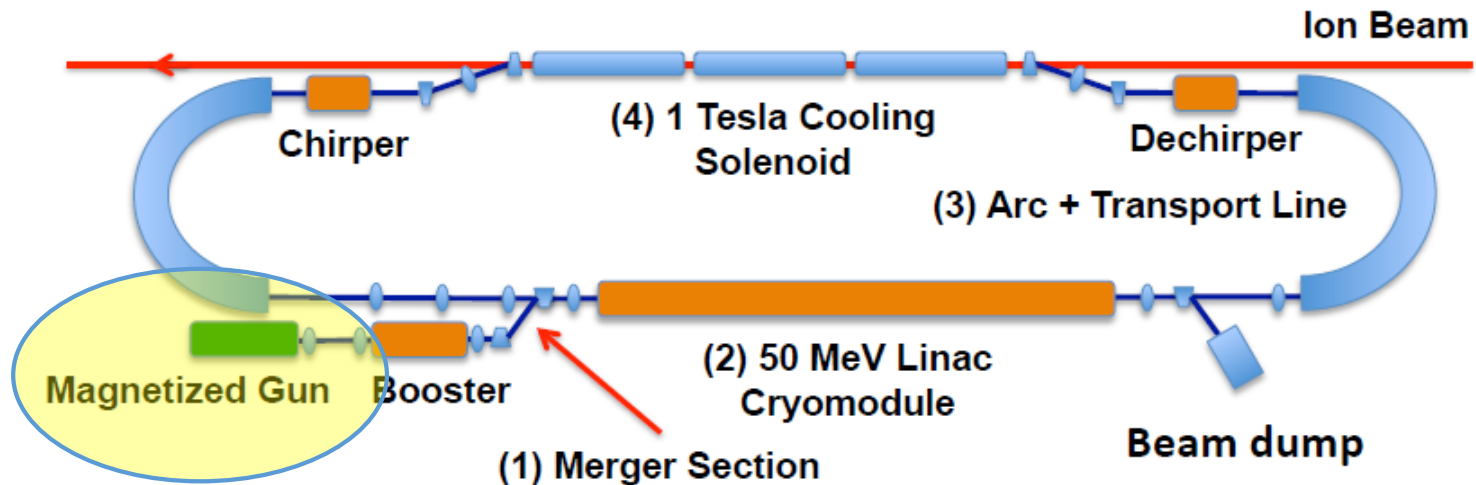
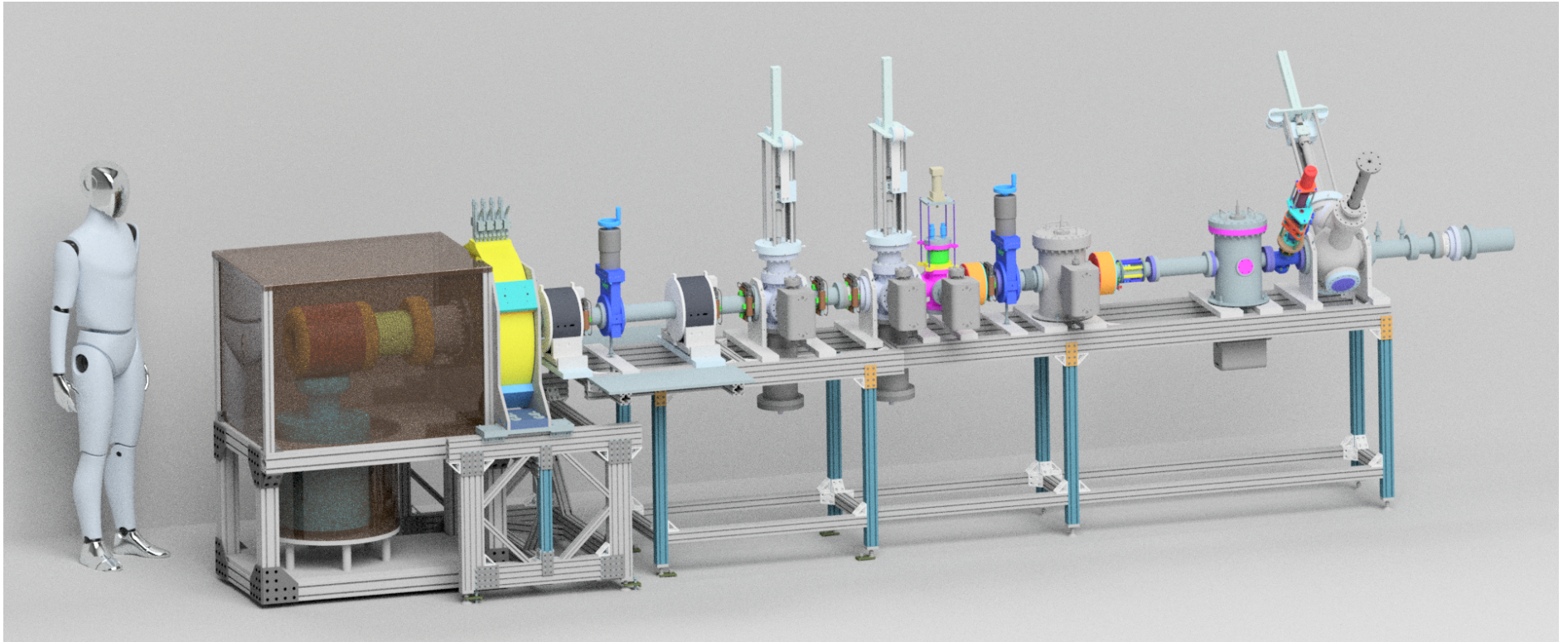

Figure 1.1: A schematic of a magnetized electron cooling system proposed for the JJefferson Lab Electron-Ion Collider (JLEIC) [5]. A magnetized beam is produced in the injector, merged (1) into the linac where it is accelerated to 55 MeV (2), and then transported (3) to the interaction region in the cooling solenoid (4).



# Tgun at the Gun Test Stand at JLab





# Phase I: Magnetized Injector Design

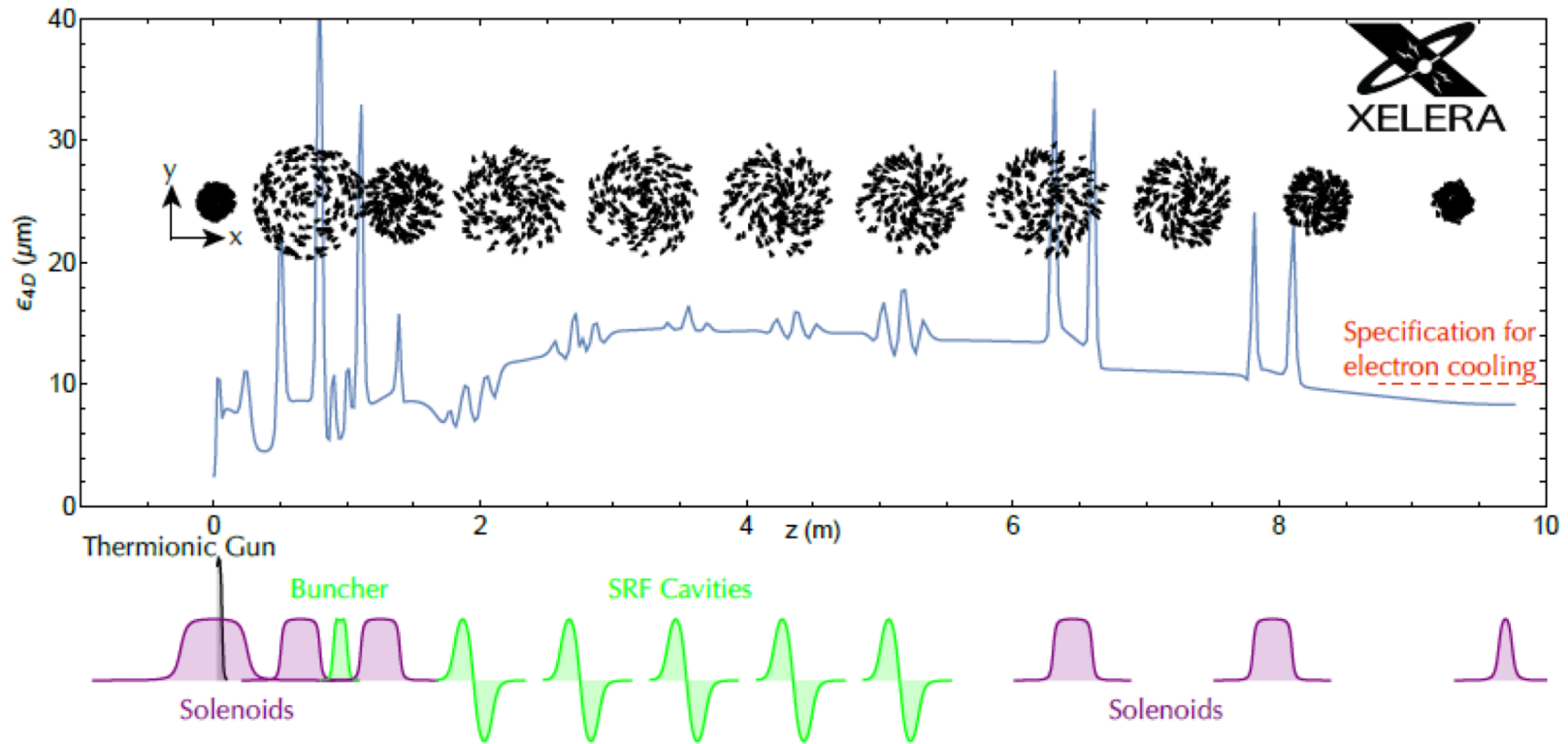



# Phase II: Build a Magnetized Source -TGun

---

## Proposal excerpts

- 1 if the beam parameters could still be met by a less complex and cheaper device. As discussed in §1.3, Phase I results indicate that with voltages as low as 200 kV the required 4D beam emittance can still be achieved. In further simulations we will continue investigating lower beam energy with the goal of still meeting ion cooling emittance requirements.
  
  - 2 scientists, we decided to propose using gridded-thermionic gun with a 100 kV beam energy and 50 mA average current, as a first step towards the final goal. These
  
  - 3 Once the gun is built and conditioned, it will be installed at JLab where its beam properties will be measured using their diagnostic beamline. If successful, a new
-





# Beam Physics Design

Want optimal solution for low energy gun that works in GTS

Gun and Magnetizing Solenoid: 2D field maps

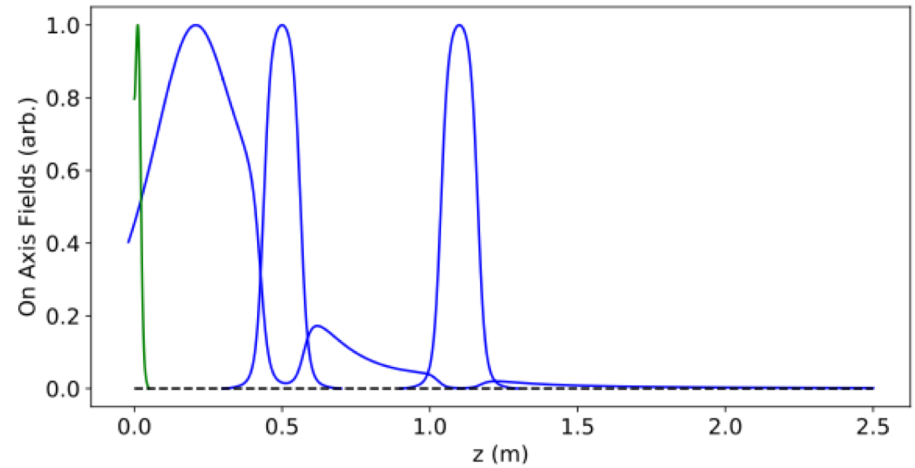
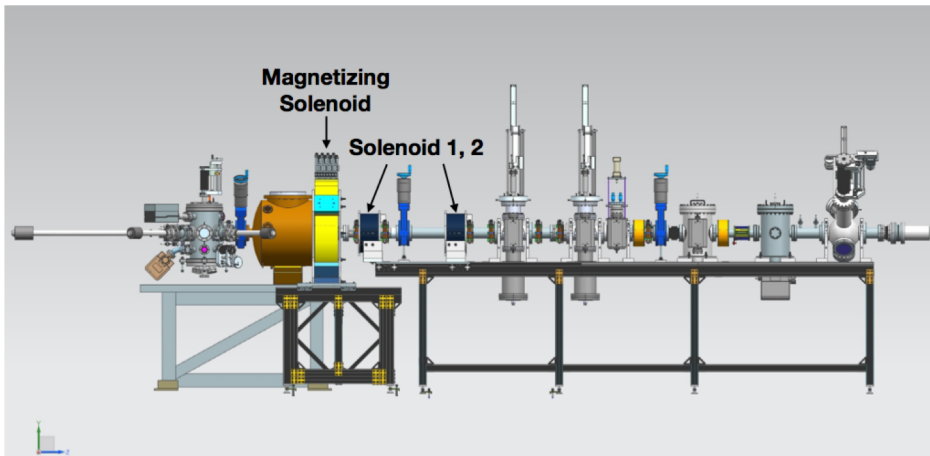



# Optimization: Initial Beam/Gun Parameters

Subsystem	Parameter	Value
Cathode	Emission Radius $R_e$ (mm)	4
	RF Voltage $U_{rf}$ (Volt)	250
	RF Frequency $f$ (MHz)	500
	Transconductance $g_{21}$ (mA/Volt)	10
	Max Temperature $T_c$ (Kelvin)	1500
	Maximum Peak Current $I_{p,max}$ (A)	1.25
Cathode Solenoid	Cathode Field $B_{cathode}$ (T)	0.0307
Gun	Voltage $V$ (kV)	125
	Cathode-Anode Gap $L$ (mm)	[5, 30]
	Cathode Angle $\theta_c$ (deg)	[15, 45]
	Anode Angle $\theta_a$ (deg)	[15, 45]
Initial Beam	Bunch Charge $q_b$ (pC)	[0, 545]
	RMS Bunch Length $\sigma_t$ (ps)	[0, 147]
	Half Emission Angle $\psi$ (deg)	[0, 60]
	Thermal Emittance $\epsilon_{n,therm}$ ( $\mu\text{m}$ )	1.0
	Initial Emittance $\epsilon_{n,x,0} = 2\epsilon_{n,therm}$ ( $\mu\text{m}$ )	2.0
	Magnetized Emittance $\epsilon_{n,mag}$ ( $\mu\text{m}$ )	36
	Canonical Angular Momentum $\langle \mathcal{P}_\theta \rangle$ (neV.s)	122.8
	Transverse Thermal Energy $k_B T$ (meV)	129.26
	Effective Mean Transverse Energy $MTE_{eff}$ (meV)	517.04

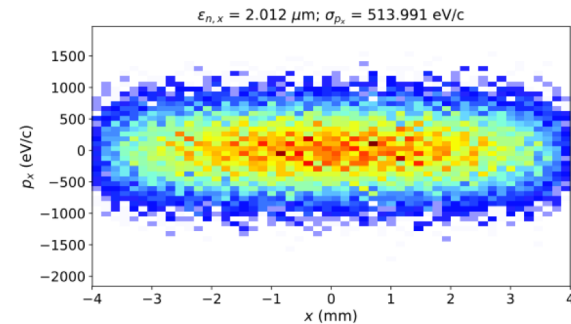
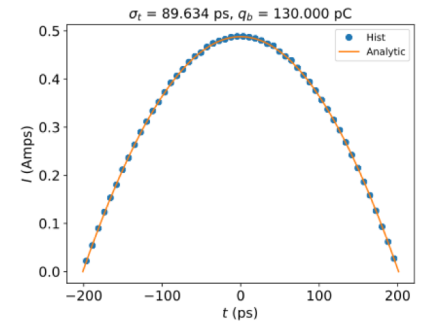
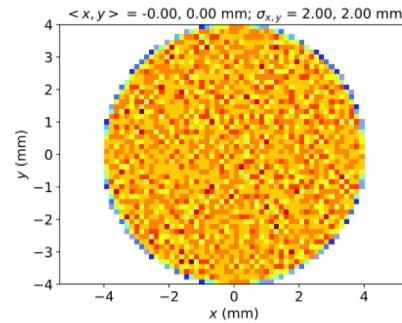



# Optimization of Gun Parameters

- Cathode Anode Gap: 5-30 mm
- Cathode Angle: 15 - 45 deg
- Anode Angle: 15 - 45 deg
- Solenoid Strengths
- Optimized @ screen  $z = 2.5$  m

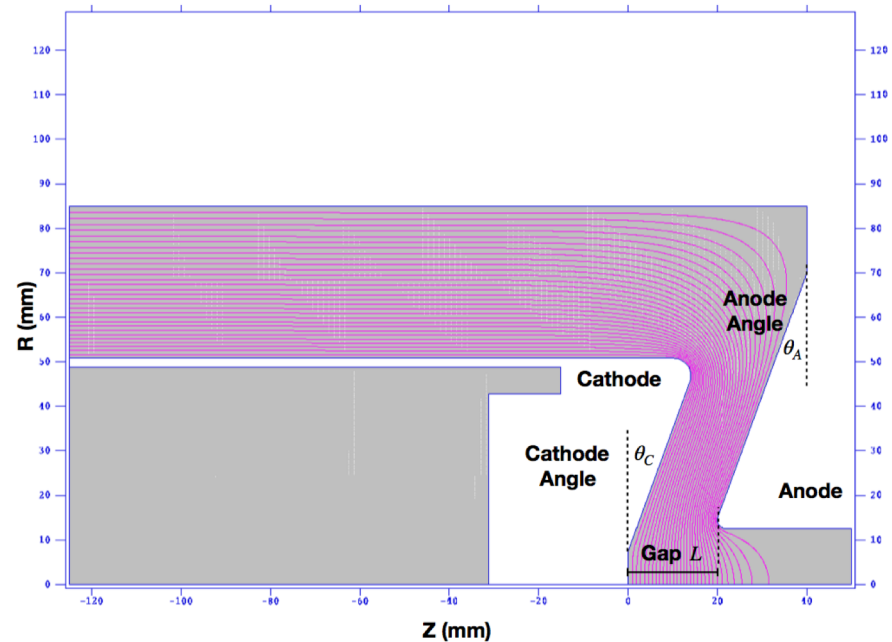



## Optimal Solution

- After several parallel Multi-Objective Genetic Algorithm Optimizations, fixed on a single electrode design
- Gap 26 mm (Optimal: 20 mm, but keeps fields down, negligible penalty to emittance)
- Meets beam dynamics requirements:
  1. Magnetized beam
  2. Bunch charge sufficient for high current demonstration

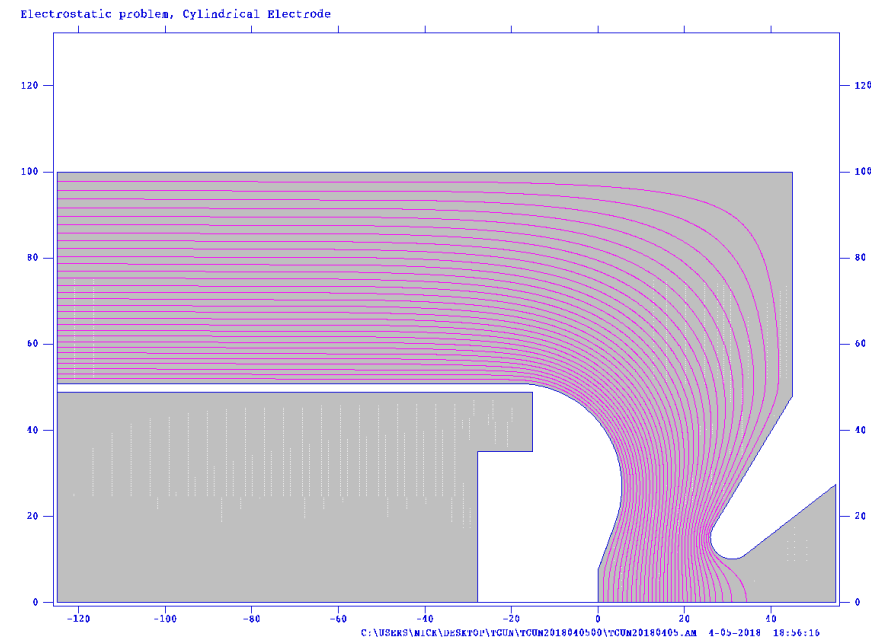



# 130 pC Solution: Beam Size Evolution through GTS

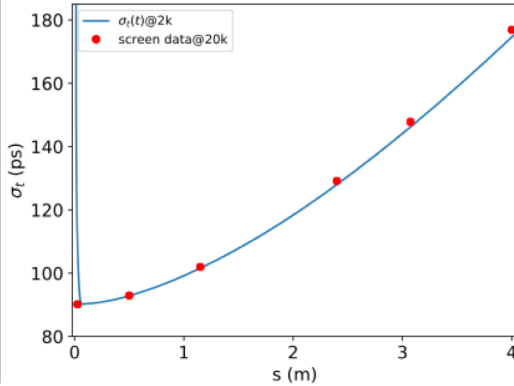
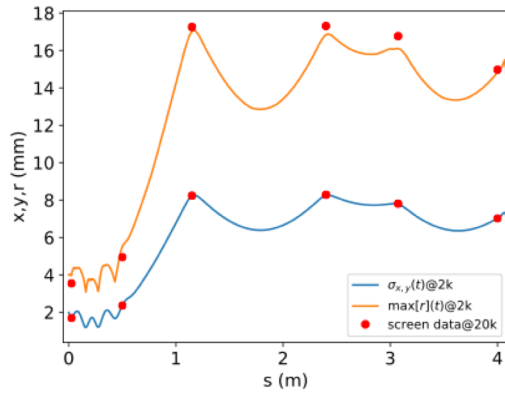

### Transverse Profile (Cathode)

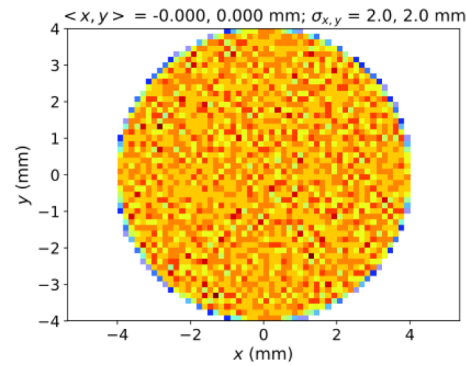

### Current Profile (Cathode)

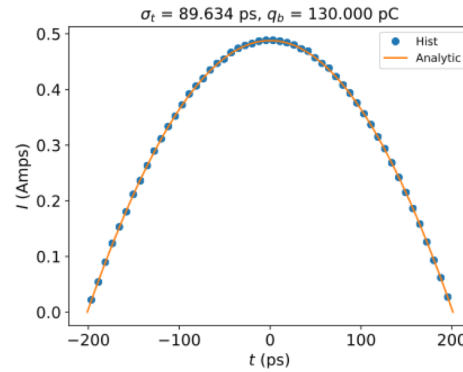

### Transverse Profile (4.0 m)

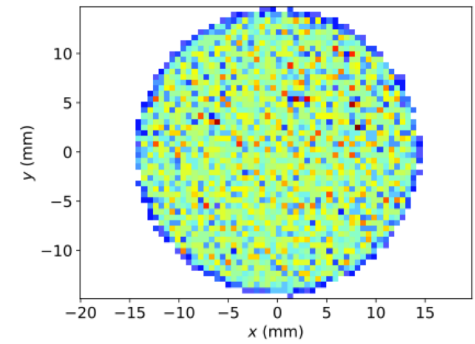

### Current Profile (4.0 m)

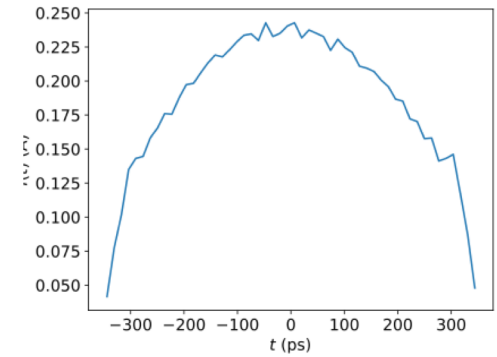



# 130 pC Solution: Emittance Evolution

Magnetization (4 m)

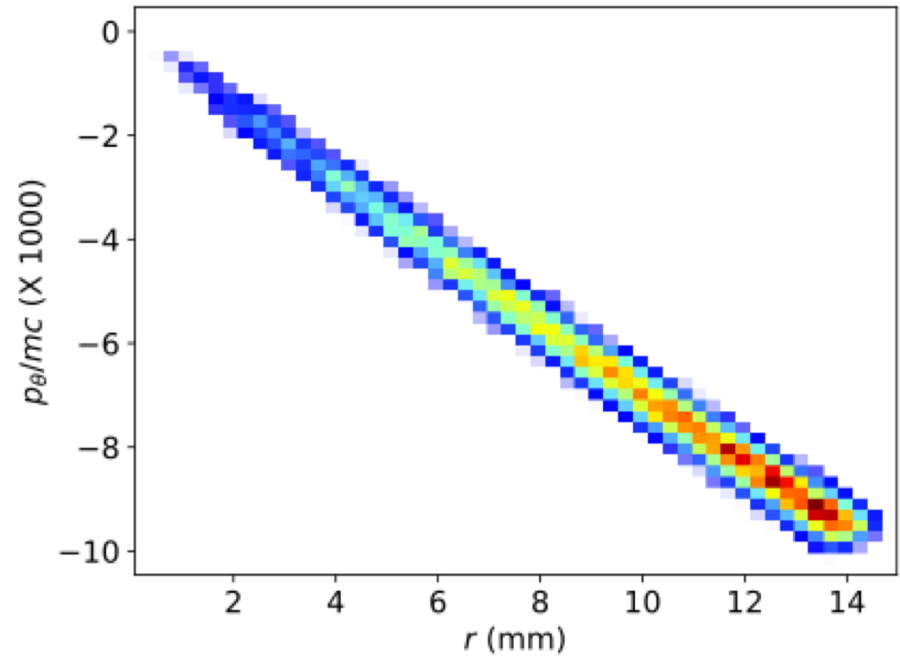
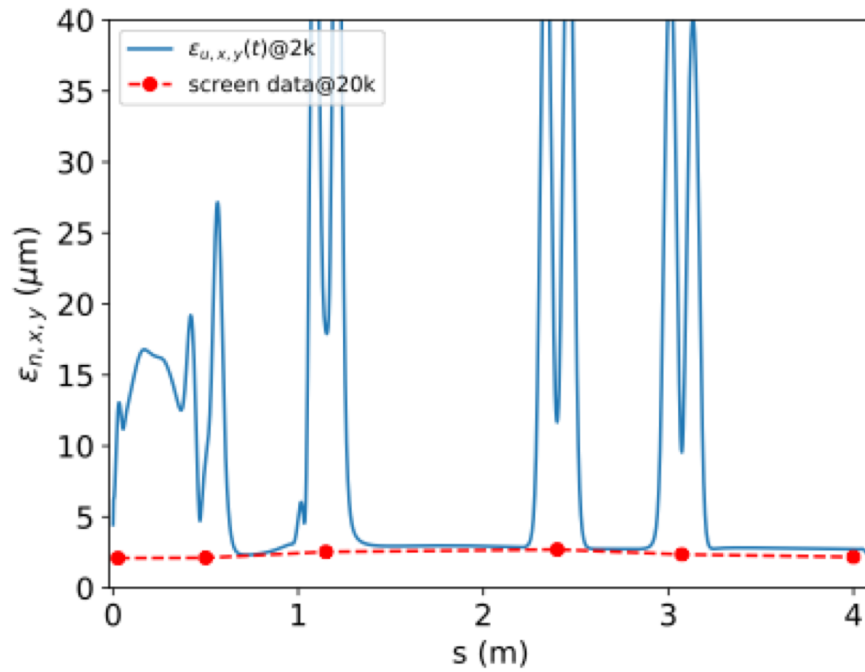



# Physics design summary

---

RF Frequency: 500 MHz (subharmonic of 1500 MHz)

Cathode: CPI Y-845, R = 0.4 cm.

Nominal bunch charges: 20 pC, 130 pC

Cathode/Electrode geometry determined by Multi-Objective Genetic Optimization (MOGA):

- Gap = 26 mm,
- Cathode Angle 20 deg,
- Anode Angle = 31 deg

Emittance (~2 micron) preserved along 4 meters of GTS for a magnetized emittance of about 36 micron.

---



# Complete Model in Poisson (LANL)

Electrostatic problem, Cylindrical Electrode

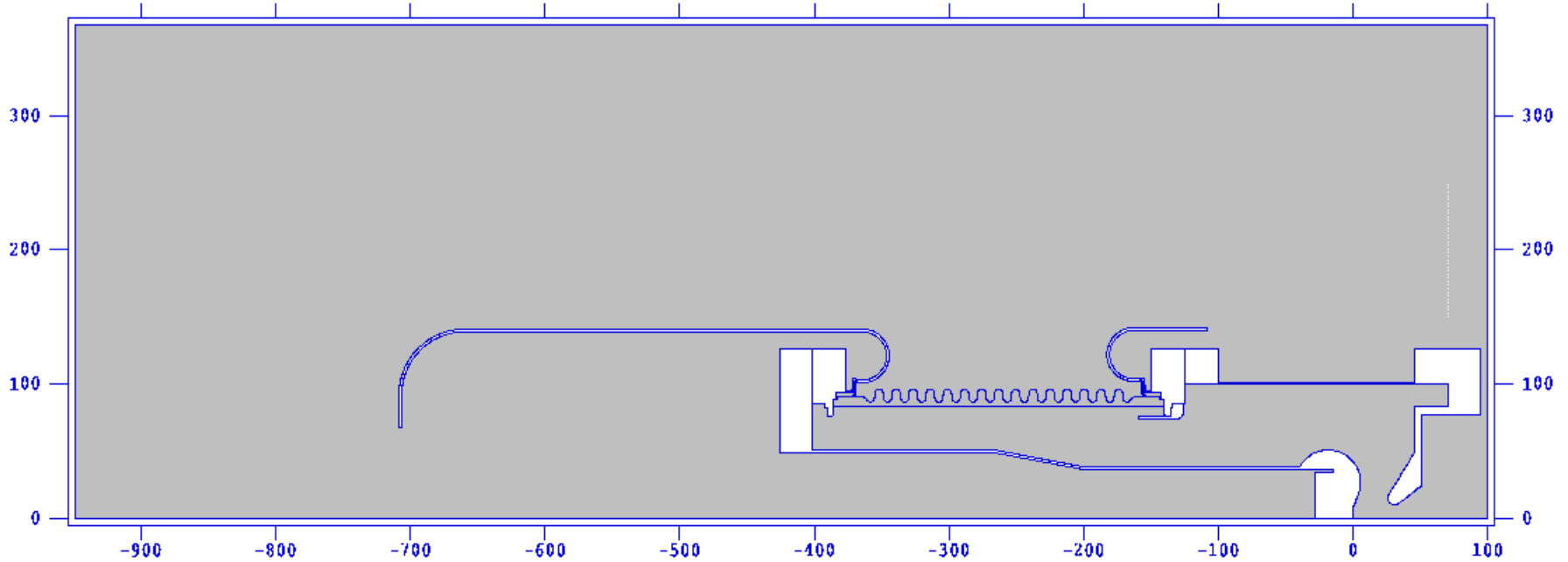





# Electrostatic Design

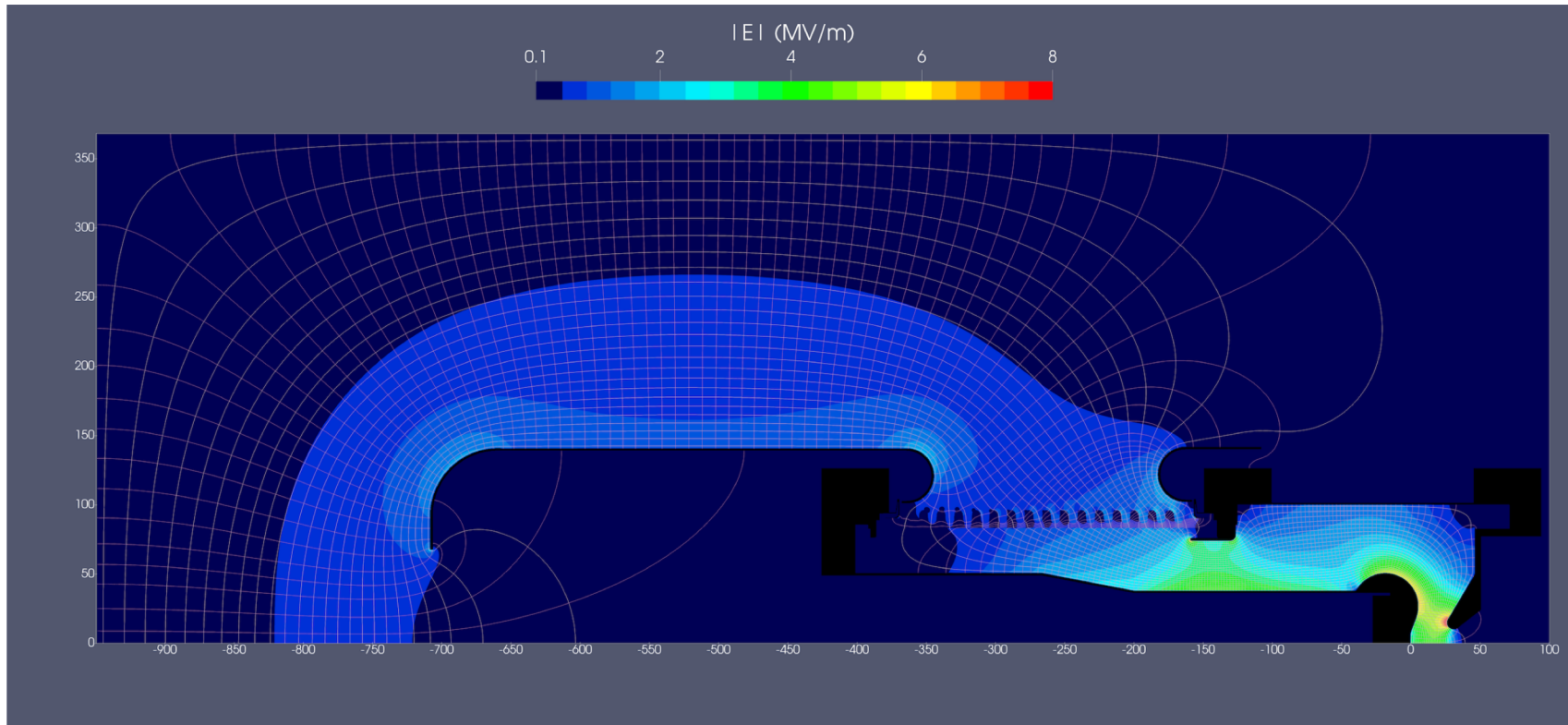



# Close up on Anode-Cathode Gap Region

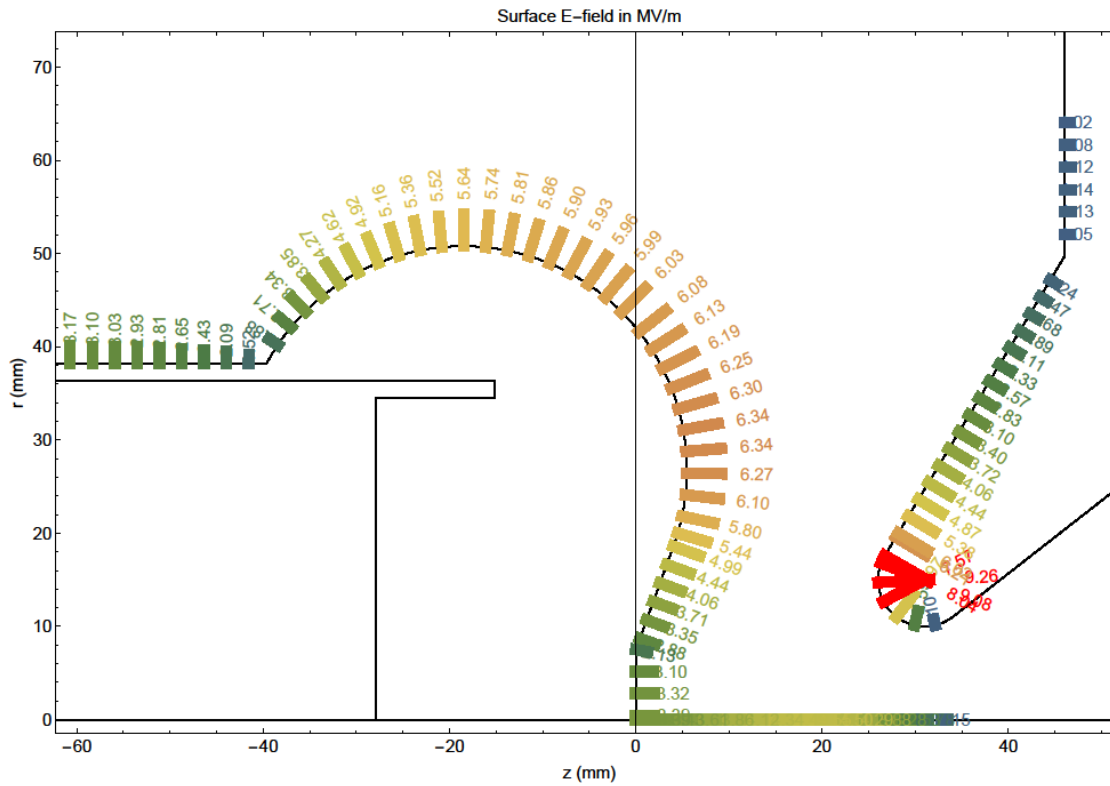

Max surface field on Cathode about 6.3 MV/m



# Poisson Convergence Study

Full Geometry

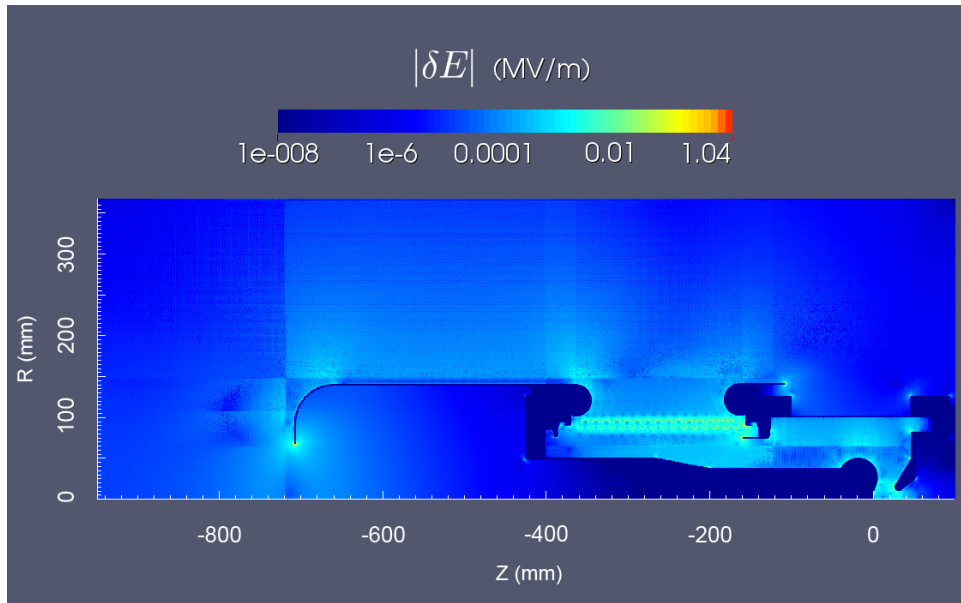

Cathode Detail

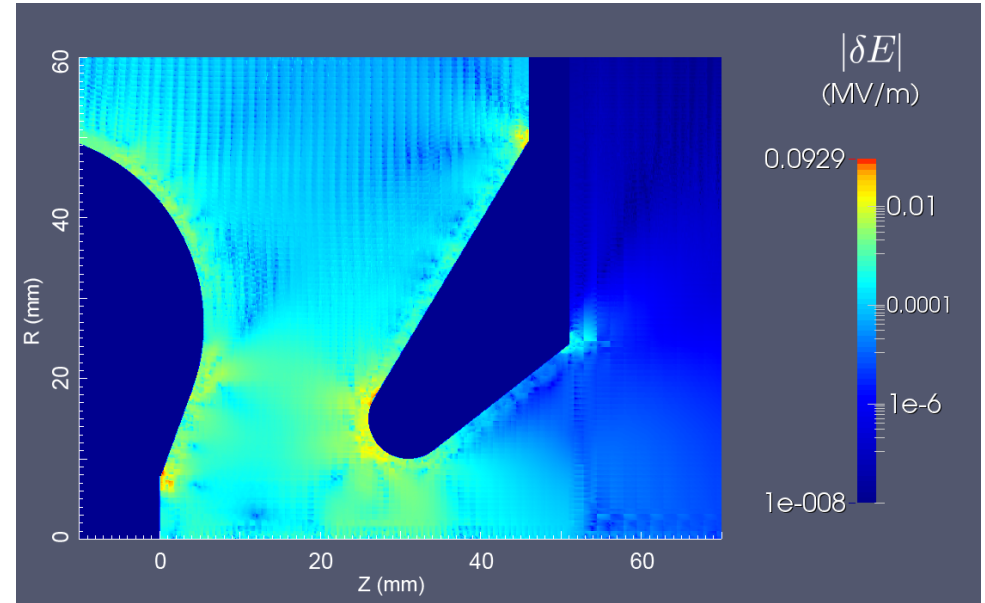



# Conceptual RF Drive Layout

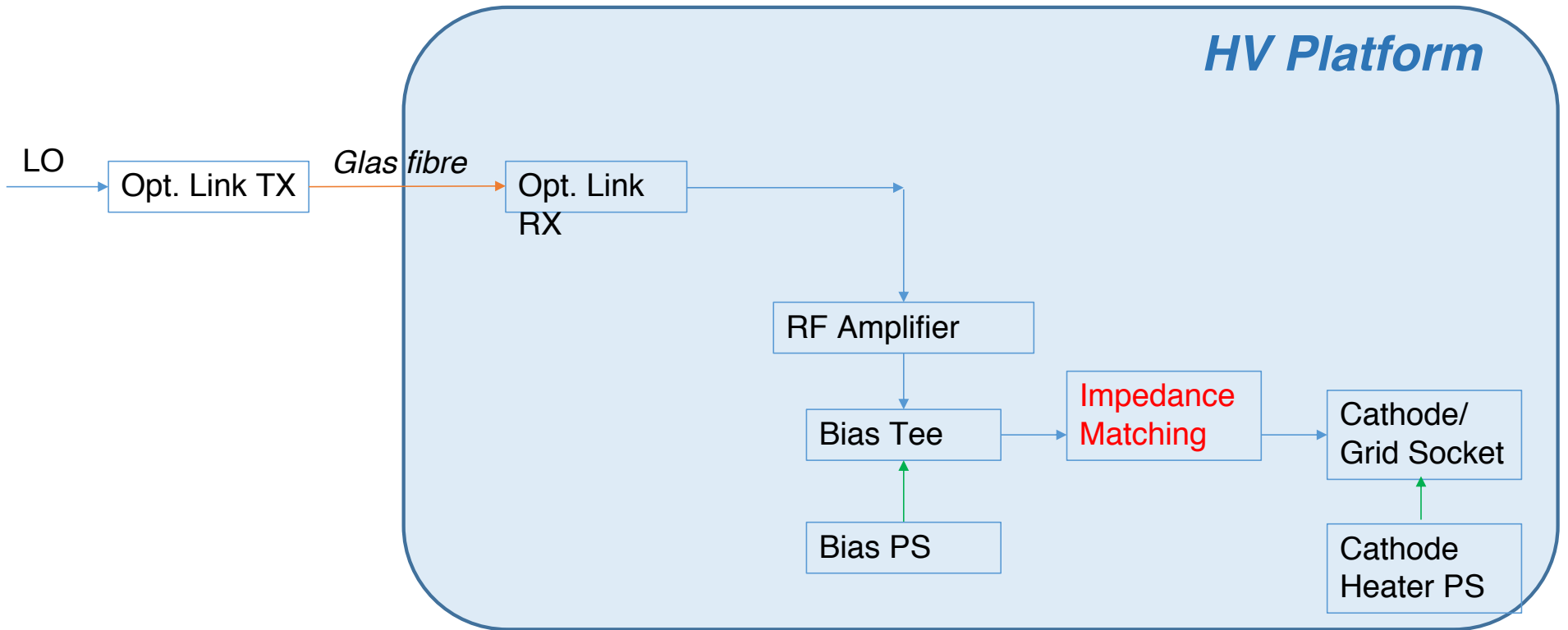

# RF design

- RF Design is mostly done
- RF Components and suppliers have been identified
- Long lead time items have been ordered (fibre link, power amplifiers)
- Other components are typically off the shelf or less than 4 weeks ARO  
-> order will be placed shortly after the review
- Impedance matcher is (RF)-designed, mechanical design is progressing

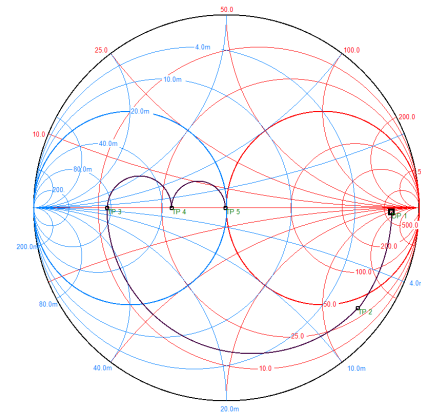

Impedance matching design



Back of Cathode as received

# Vacuum System Mechanical Design

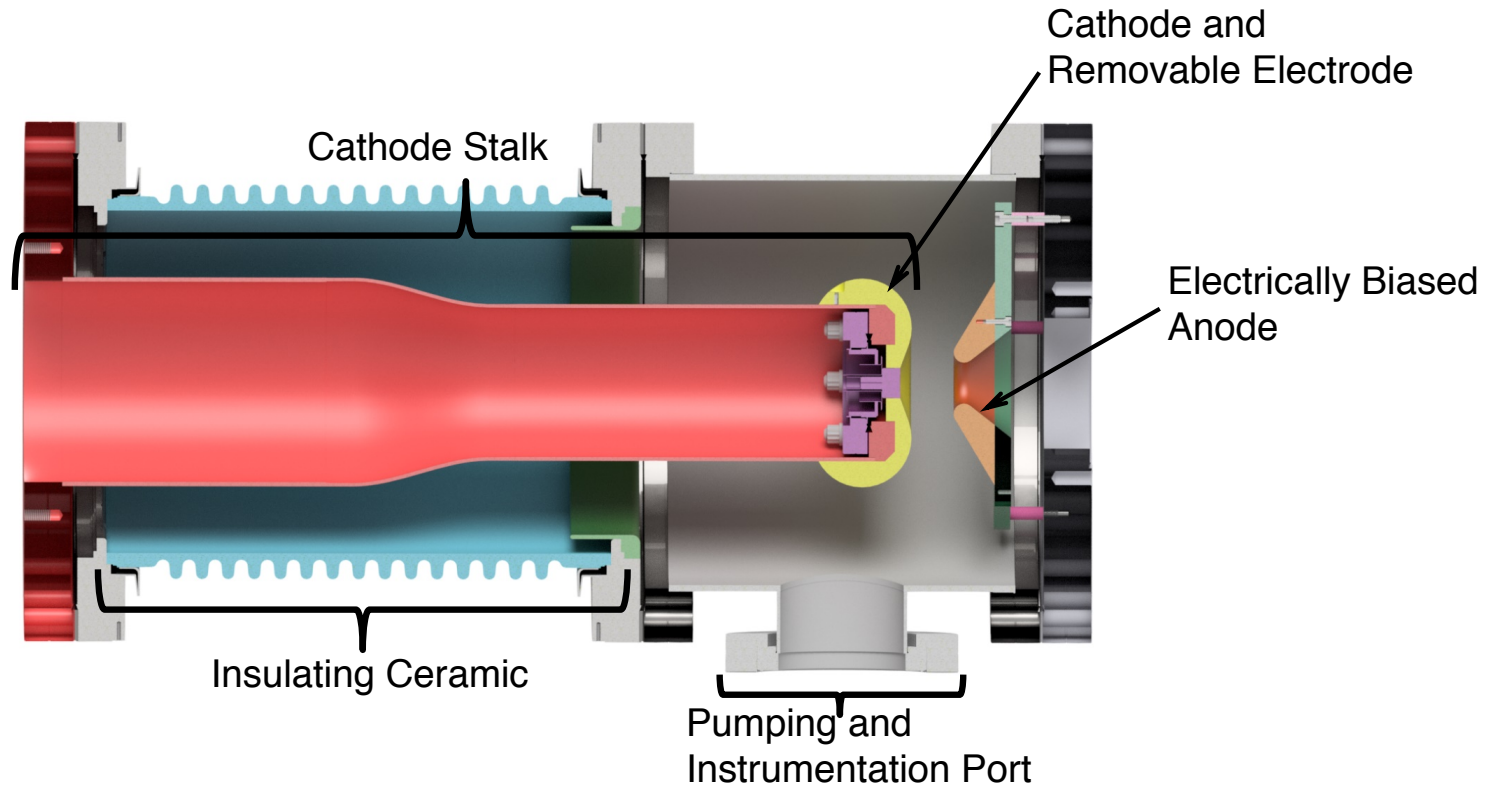



# Full Gun Design

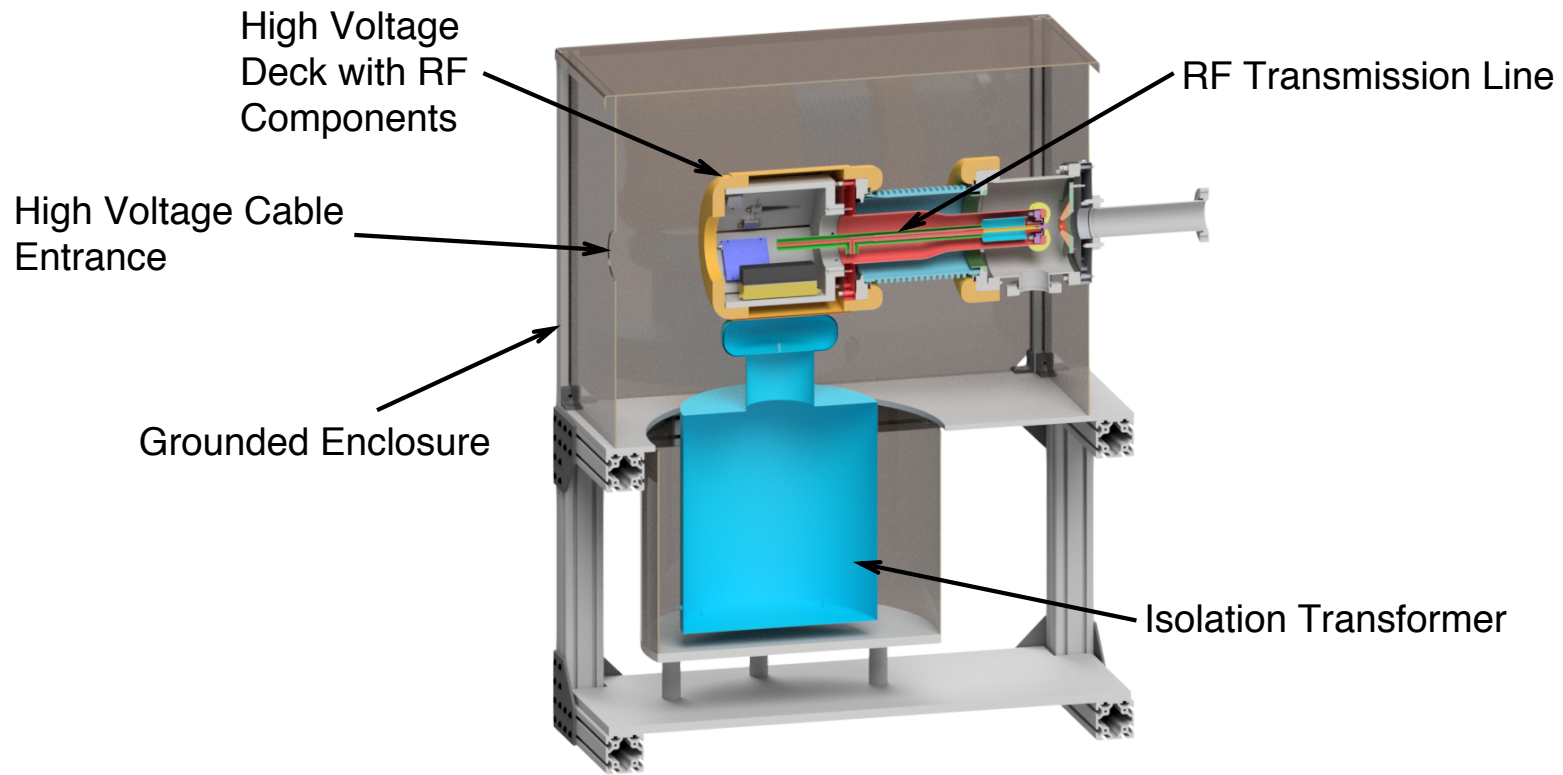



# XELERA TGun in JLAB GTS Beamline

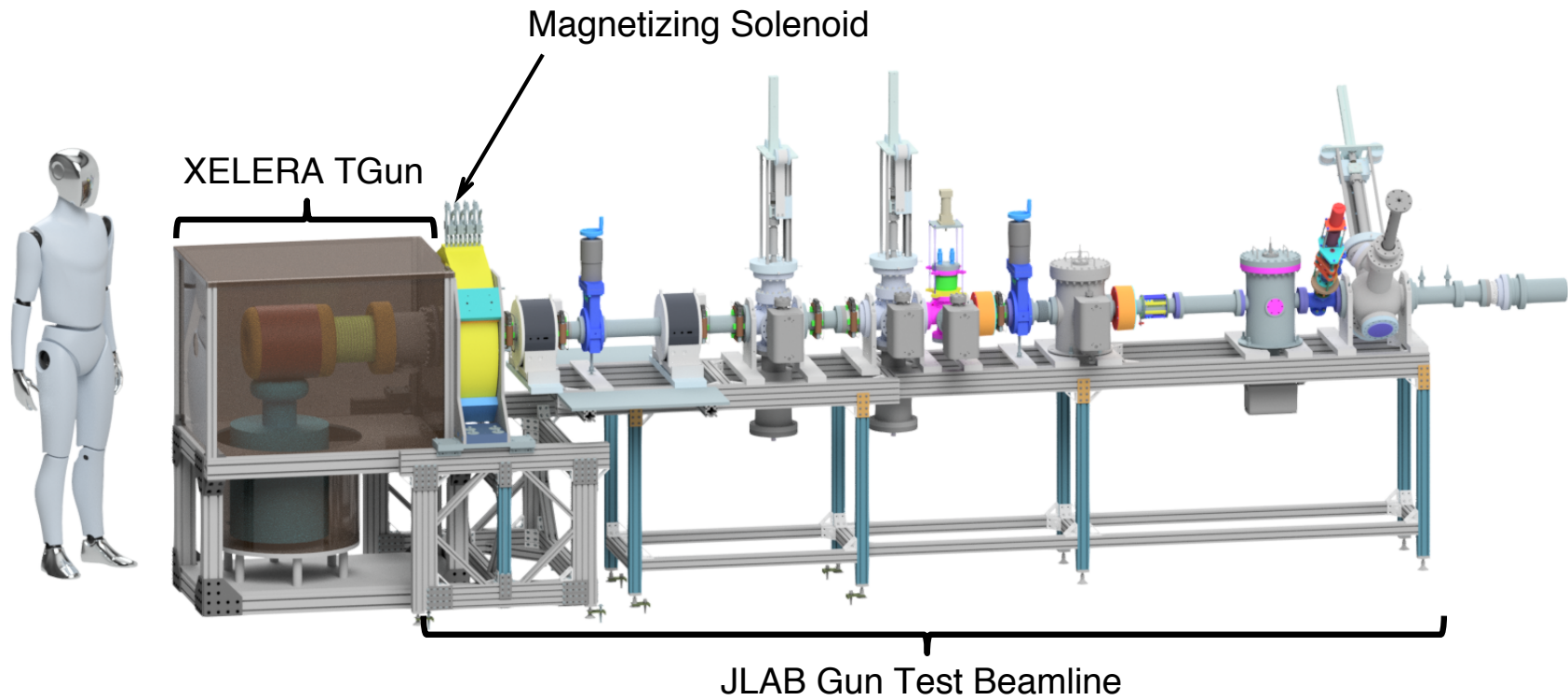





# Schedule

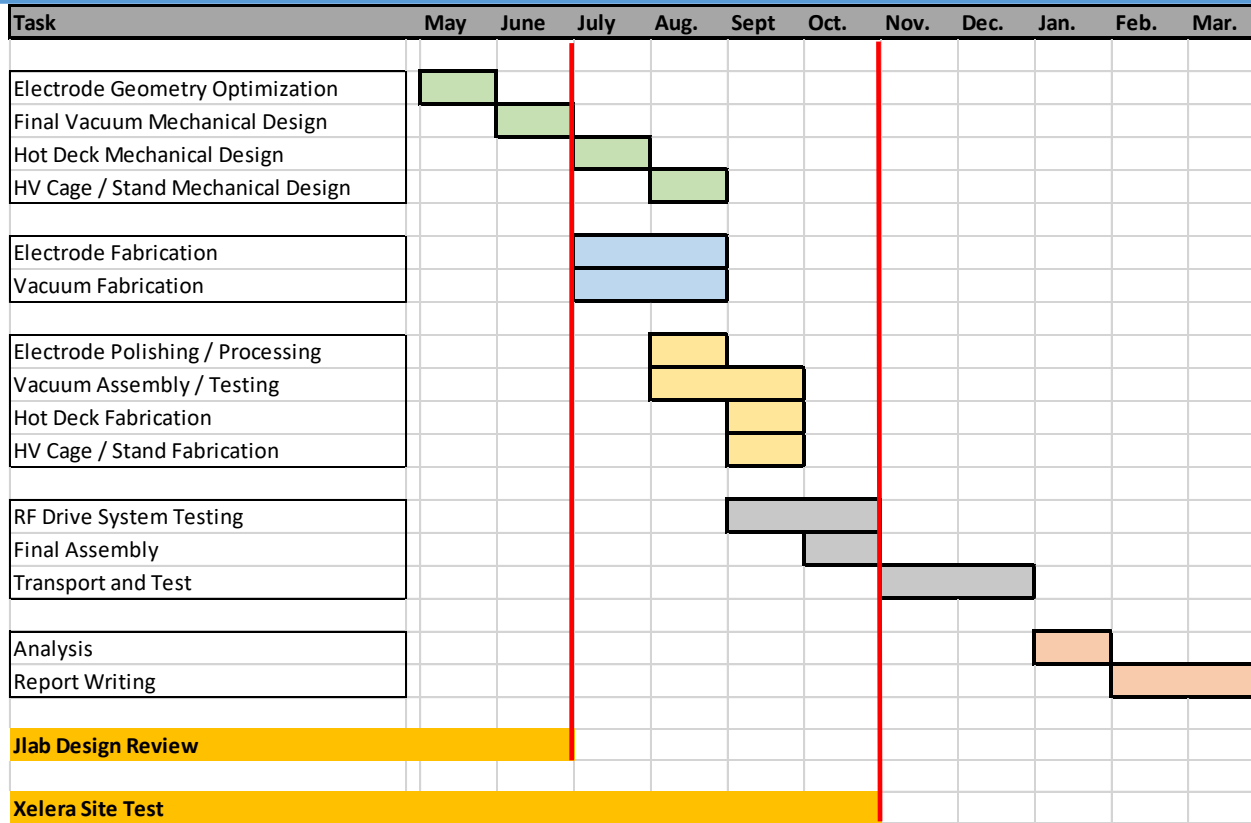



# Summary

---

- Xelera formed from the former Cornell ERL team in 2013.
  - In house developed highly parallel cloud-based software tools for accelerator optimization and design.
  - Mechanical design and fabrication expertise: including cleanroom, vacuum lab, and machine shop for low volume manufacture.
  - Phase I: Design studies and optimizations for a magnetized injector (complete).
  - Phase II: Build a prototype Thermionic gun (Tgun) to produce a magnetized beam.
  - Specifications and design developed in close collaboration with Jlab injector group.
  - Design is complete, beginning fabrication now.
  - JLab test at the Gun Test Stand (GTS) late this year.
-



END

