

Magnetized Electron Source

This work is supported by the Department of Energy, Laboratory Directed Research and Development (LDRD) funding, under contract DE-AC05-06OR23177

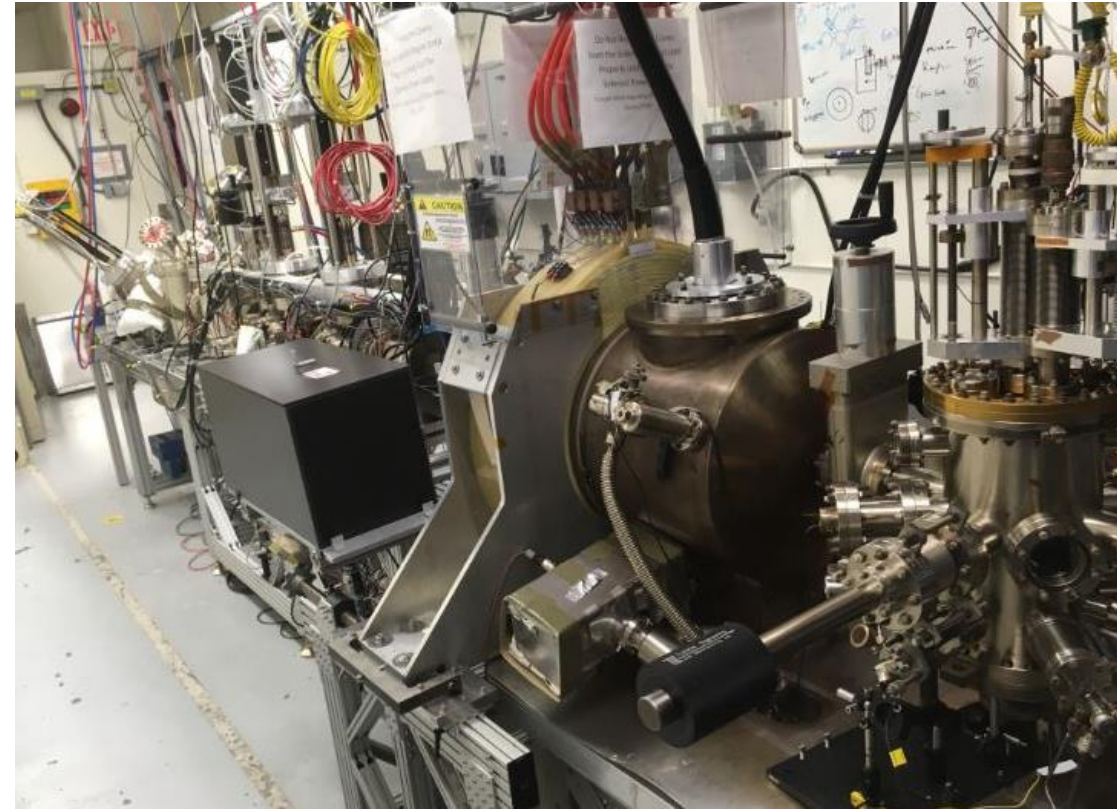

Riad Suleiman

Jefferson Lab

2018 Accelerator R&D PI Exchange Meeting

November 13-14, 2018

Outline

- LDRD Goals, Budget, Deliverables and Schedule
- Magnetized Bunched-Beam Electron Cooling at Jefferson Lab Electron Ion Collider (JLEIC)
- LDRD Magnetized Electron Source:
 - K_2CsSb Photocathode and HV Chamber
 - Cathode Solenoid
 - Beamline
- Characterization of Magnetized Beam:
 - Beam Size and Shearing Angle
 - Drift Emittance
 - High Bunch Charge
 - High Average Current and Charge Lifetime
- Future Plans
- Summary

Jefferson Lab LDRD Goals

- Project, “Generation and Characterization of Magnetized Bunched Electron Beam from DC Photogun for JLEIC Cooler”, was funded by Jefferson Lab LDRD program. This was three-year project concluded on September 30, 2018.
- LDRD Goals:
 - I. Generate magnetized electron beam from dc high voltage photogun and measure its properties
 - II. Exploring impact of cathode solenoid on photogun operation
 - III. Simulations and measurements will provide insights on ways to optimize JLEIC electron cooler and help design appropriate source
 - IV. Jefferson Lab will have direct experience on magnetizing electron beams at high currents

Jones report

Row No.	Proponent	Concept / Proponent Identifier	Title of R&D Element	Panel Priority	Panel Sub-Priority
18	PANEL	JLEIC	Develop a high current magnetized electron injector	High	B

Budget

FY16	\$339,211
FY17	\$264,979
FY18	\$211,449
Total	\$815,639

- Materials and Supplies:

1. Cathode solenoid magnet
2. Beamline hardware: steering magnets and slits
3. Laser components

- Labor:

1. Cathode solenoid design, mapping and installation
2. Mechanical designer
3. Beam simulations with A Space Charge Tracking Algorithm (ASTRA) and General Particle Tracer (GPT)
4. Postdoc (FY17 and FY18)

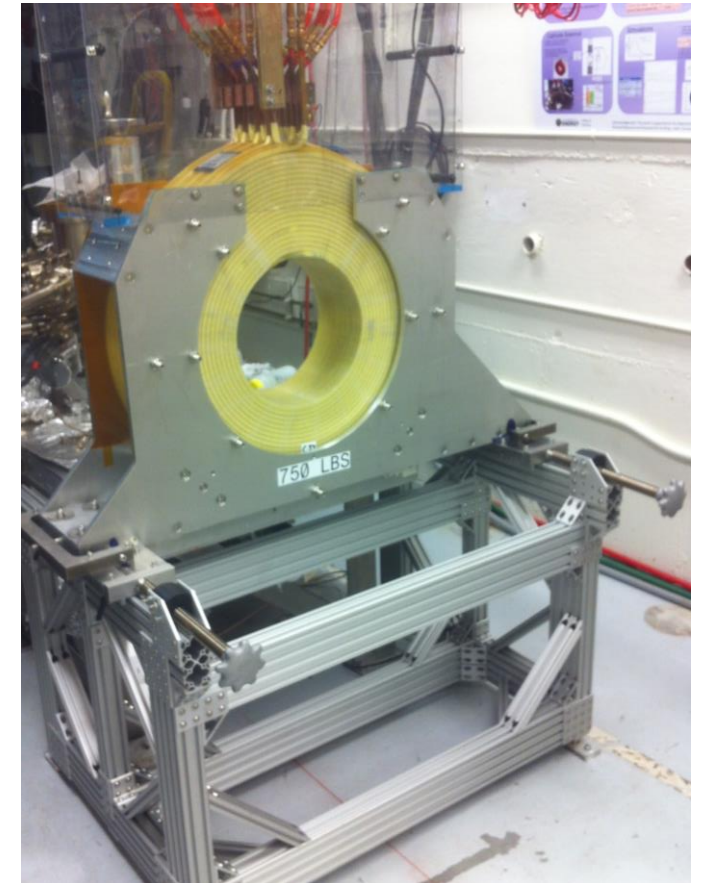

Deliverables and Schedule

- FY16:

1. HV condition gun to 350 kV and build K_2CsSb preparation chamber
2. Design beamline. Design and procure slits
3. Design and procure cathode solenoid magnet
4. Measure lifetime at 1 mA and 300 kV (non-magnetized)
5. Install cathode solenoid magnet

- FY17:

1. Generate magnetized beam
2. Measure mechanical angular momentum vs magnetic field and laser size at photocathode
3. Benchmark simulation against measurements
4. Measure lifetime at 5 mA and 300 kV
5. Study beam halo and beam loss vs magnetic field at photocathode

- FY18:

1. Design TE_{011} cavity to measure beam magnetization (non-invasive)
2. Change to HV Supply of 30 mA and 225 kV
3. Measure photocathode lifetime at 30 mA
4. Generate high bunch charge magnetized beam
5. ~~Commission TE_{011} cavity with beam~~

Explore these magnetized beam parameters:

- $a_0 = 0.1 - 1$ mm, $B_z = 0 - 1.5$ kG
- Bunch charge: up to 0.5 nC
- Frequency: 1 - 15 Hz, 100 - 500 MHz
- Average beam currents up to 30 mA
- Gun high voltage: 200 - 350 kV

JLEIC High Energy Electron Cooler

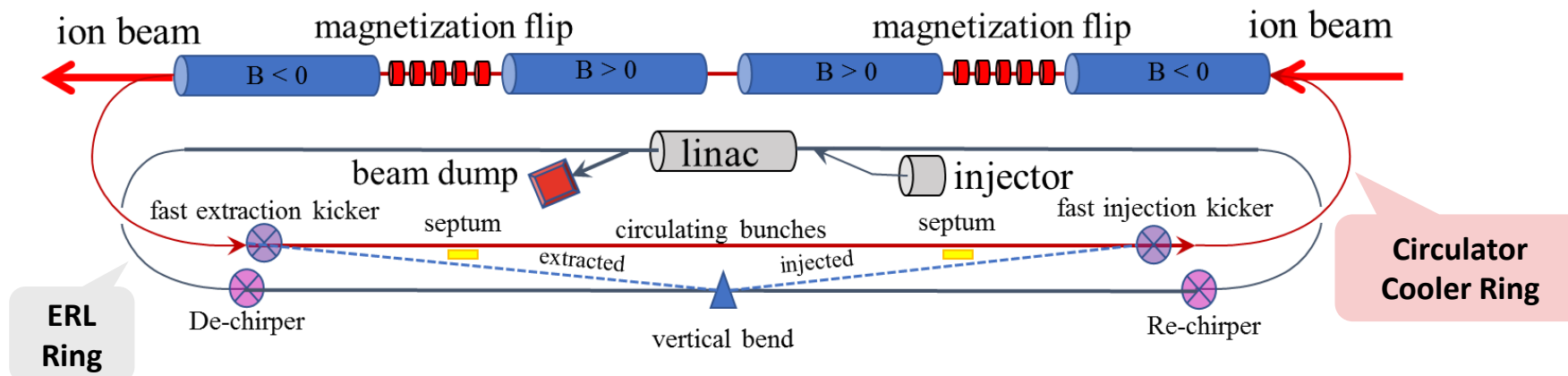
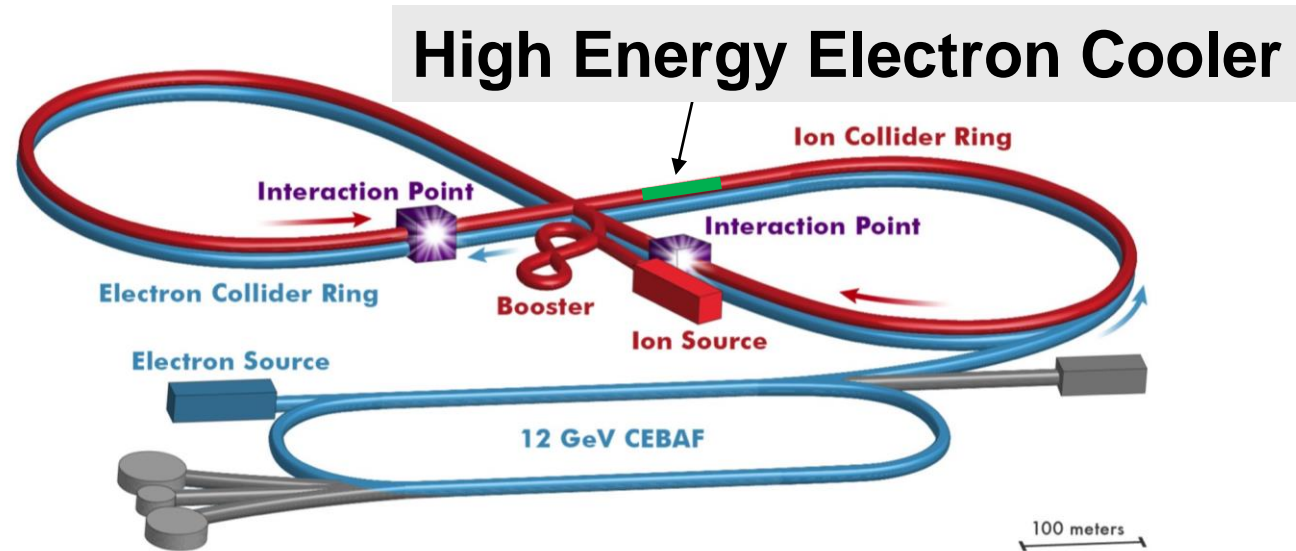

Magnetized Bunched-Beam Electron Cooling

- Ion beam cooling in presence of magnetic field is much more efficient than cooling in a drift (no magnetic field):
 - Electron beam helical motion in strong magnetic field increases electron-ion interaction time, thereby significantly improving cooling efficiency
 - Electron-ion collisions that occur over many cyclotron oscillations and at distances larger than cyclotron radius are insensitive to electrons transverse velocity
- Long cooling solenoid provides desired cooling effect:
 - Counteracting emittance degradation induced by intra-beam scattering
 - Maintaining ion beam emittance during collisions and extending luminosity lifetime
 - Suppressing electron-ion recombination

Putting electron beam into cooling solenoid represents a challenge

Magnetized Cooling Schematics

Electron beam suffers an azimuthal kick at entrance of cooling solenoid. But this kick can be cancelled by an earlier kick at exit of photogun. That is the purpose of cathode solenoid.

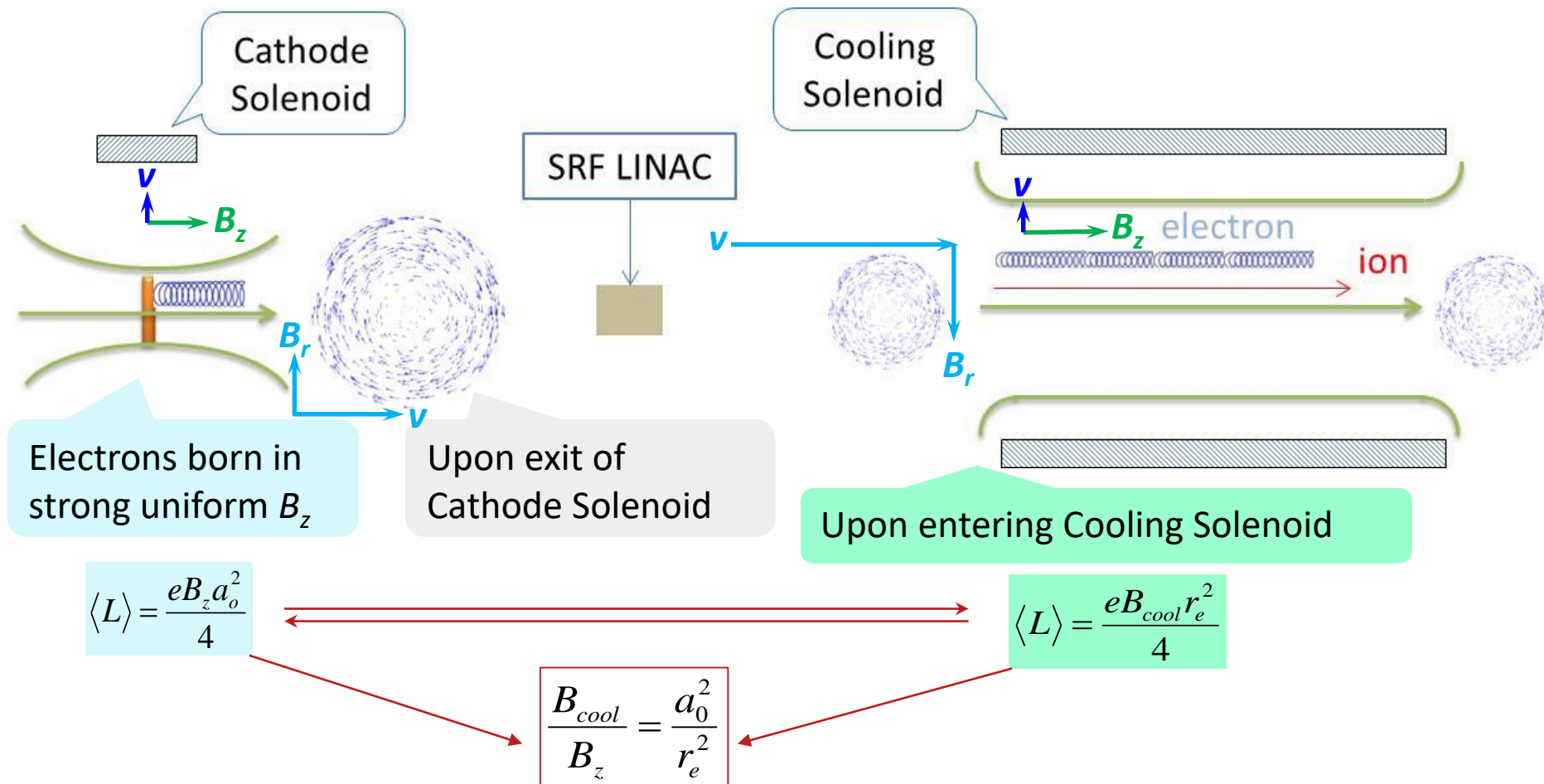

JLEIC Magnetized Source Requirements

Parameter	JLEIC Requirements	LDRD Demonstrated
Bunch length – Flat-top	60 ps (2 cm)	25 – 60 ps
Repetition rate	43.3 MHz	100 Hz – 374.3 MHz
Bunch charge	3.2 nC	0.7 nC (75 ps FWHM, 25 kHz, 225 kV, 0.76 kG)
Peak current	53.9 A	9.3 A
Average current	140 mA (400 kV)	28 mA (50 ps FWHM, 74.8 pC, 374.25 MHz, 100 kV, 0.57 kG)
Transverse normalized emittance	<19 microns	<2 microns
Normalized drift emittance	36 microns	26 microns
Cathode spot radius – Flat-top (a_0)	3.14 mm	1.70 mm
Solenoid field at cathode (B_z)	0.50 kG	1.51 kG

Beam current was limited by laser power and power of high voltage supply (30 mA/225 kV supply with 3 kW limit)

Gun Test Stand with 300 kV Inverted Gun and K_2CsSb Photocathode



Gun Test Stand in October 2015

- Salvaged un-used beamline from old project
- Designed and procured cathode solenoid that can provide magnetic field up to 1.5 kG at photocathode
- Used CEBAF spare Dogleg magnet power supply (400 A, 80 V)
- Cathode solenoid can trigger field emission but we have learned how to prevent this
- Photogun operated at 300 kV with gun solenoid at 400 A

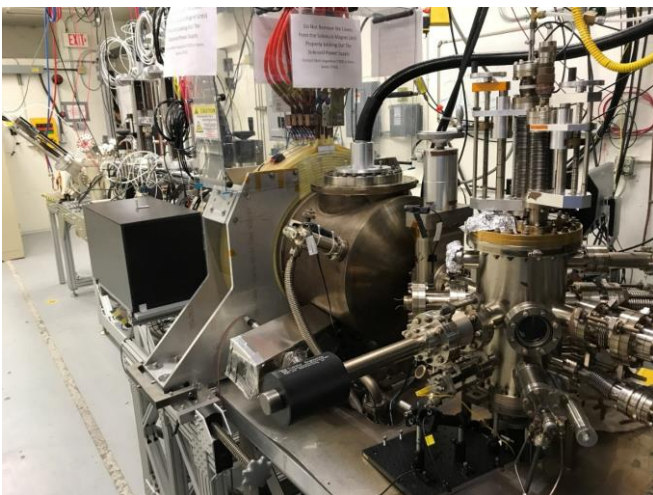

Gun Test Stand in September 2018

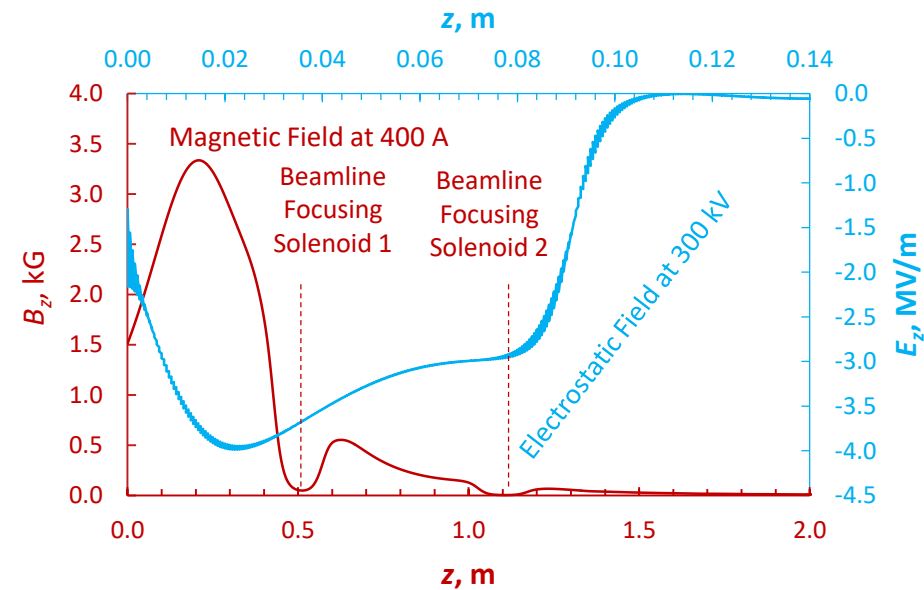

Magnetized Source Schematics

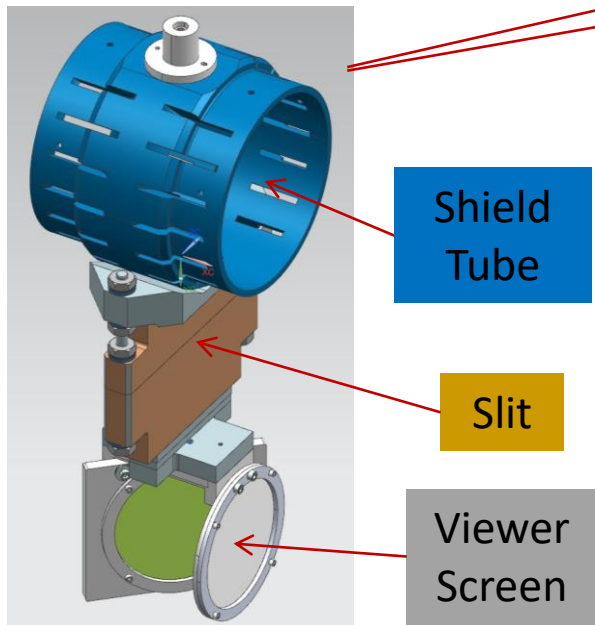
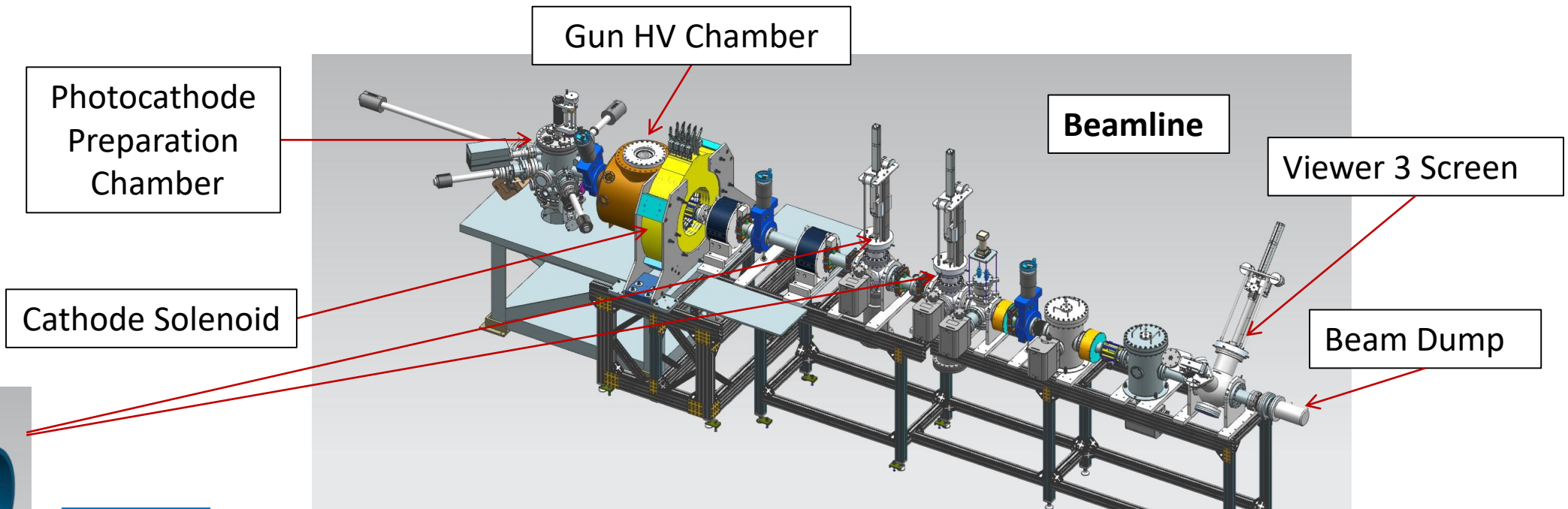

Use slit and viewscreens to characterize magnetization:

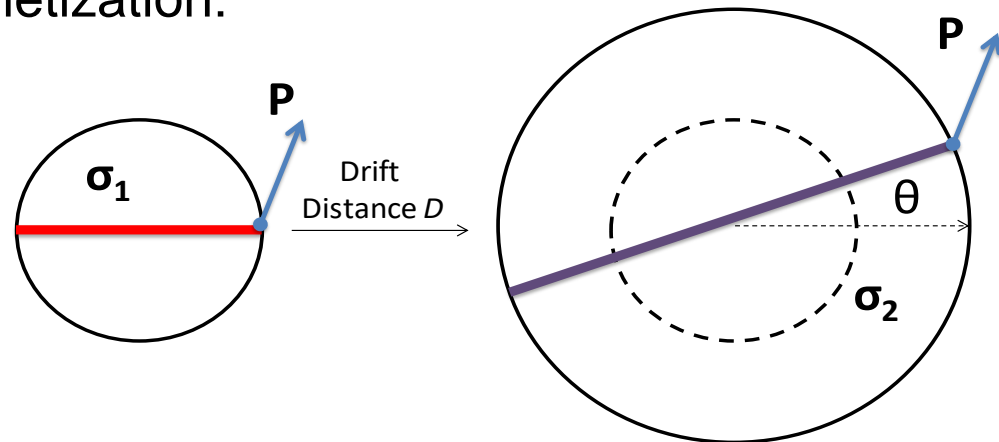

σ_i : beam size on i -th viewer
 θ : shearing angle

Beam Size and Shearing Angle

Beam and beamlet observed on successive viewers

Magnetic field at photocathode = 0 G

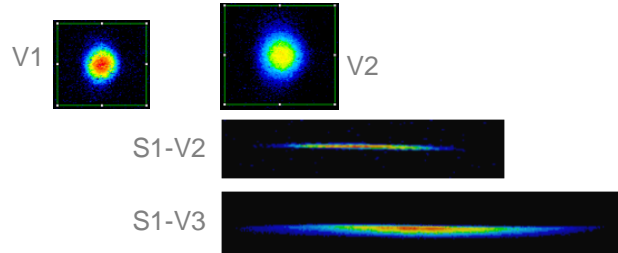

Magnetic field at photocathode = 1514 G

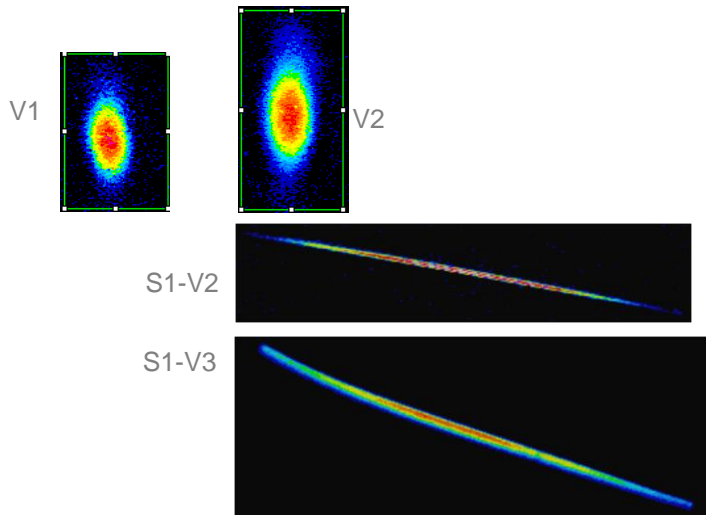

Beam size and Shearing Angle: Experiment vs Simulation

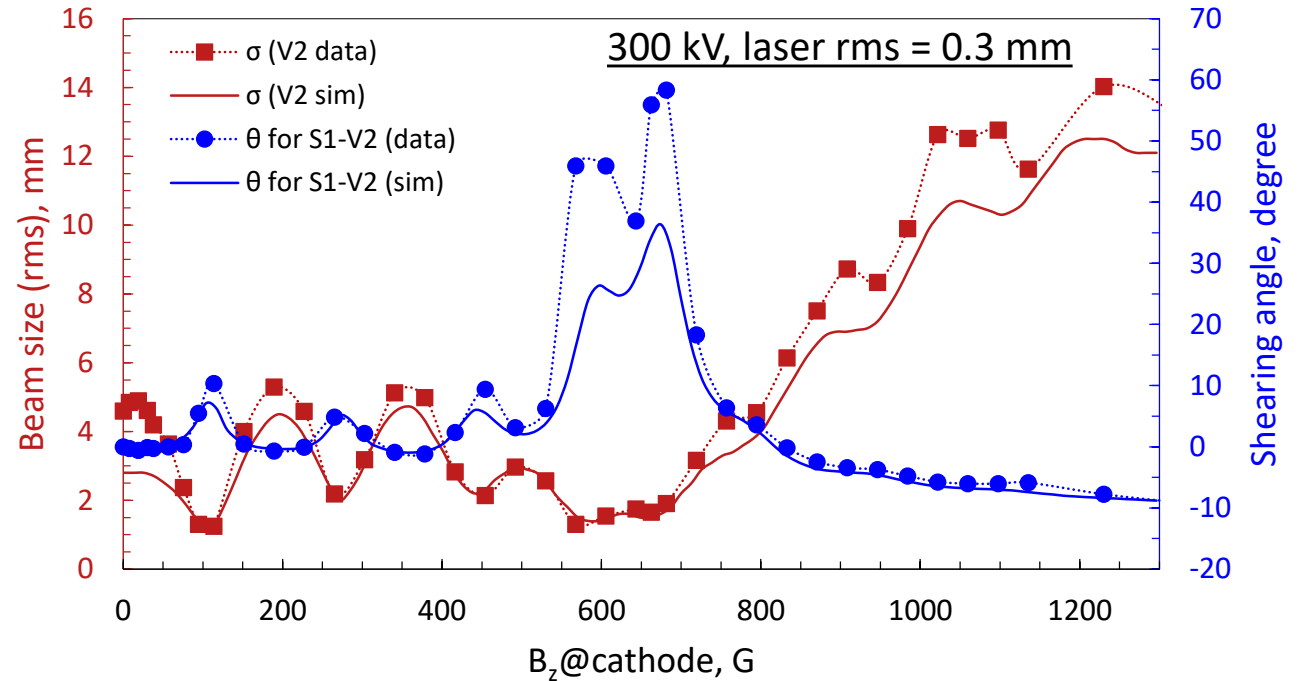

- Modelled apparatus using ASTRA & GPT
- Focusing by cathode solenoid magnetic field causes mismatch oscillations resulting in repeated focusing inside cathode solenoid field which affects beam size at exit of solenoid field and resulted in varying beam expansion in field free region

Drift Emittance

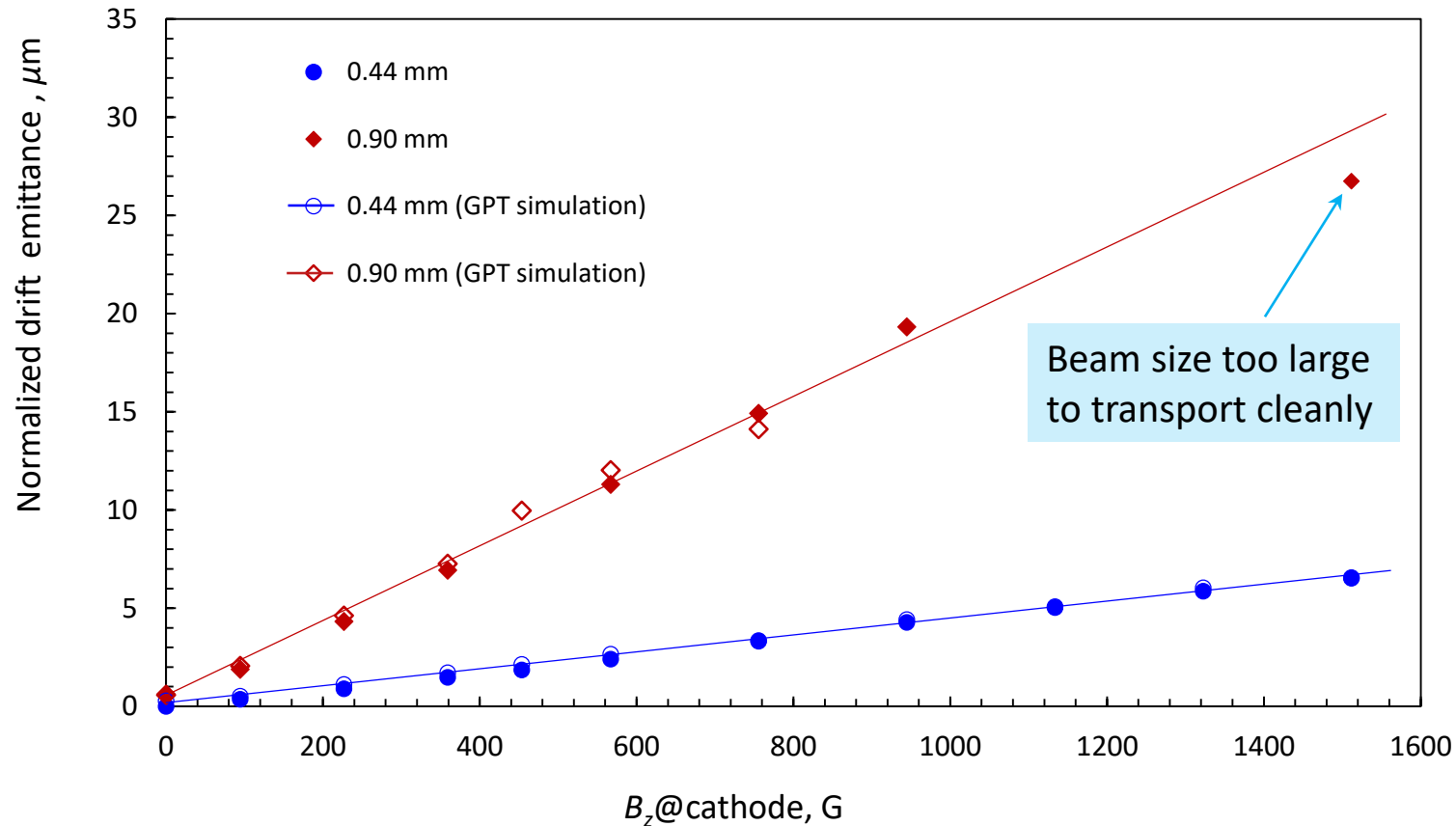

- Used beamline solenoid and viewer screen to measure drift emittance for different laser sizes at 200 kV
- GPT simulation and experimental results show good agreement

High Bunch Charge

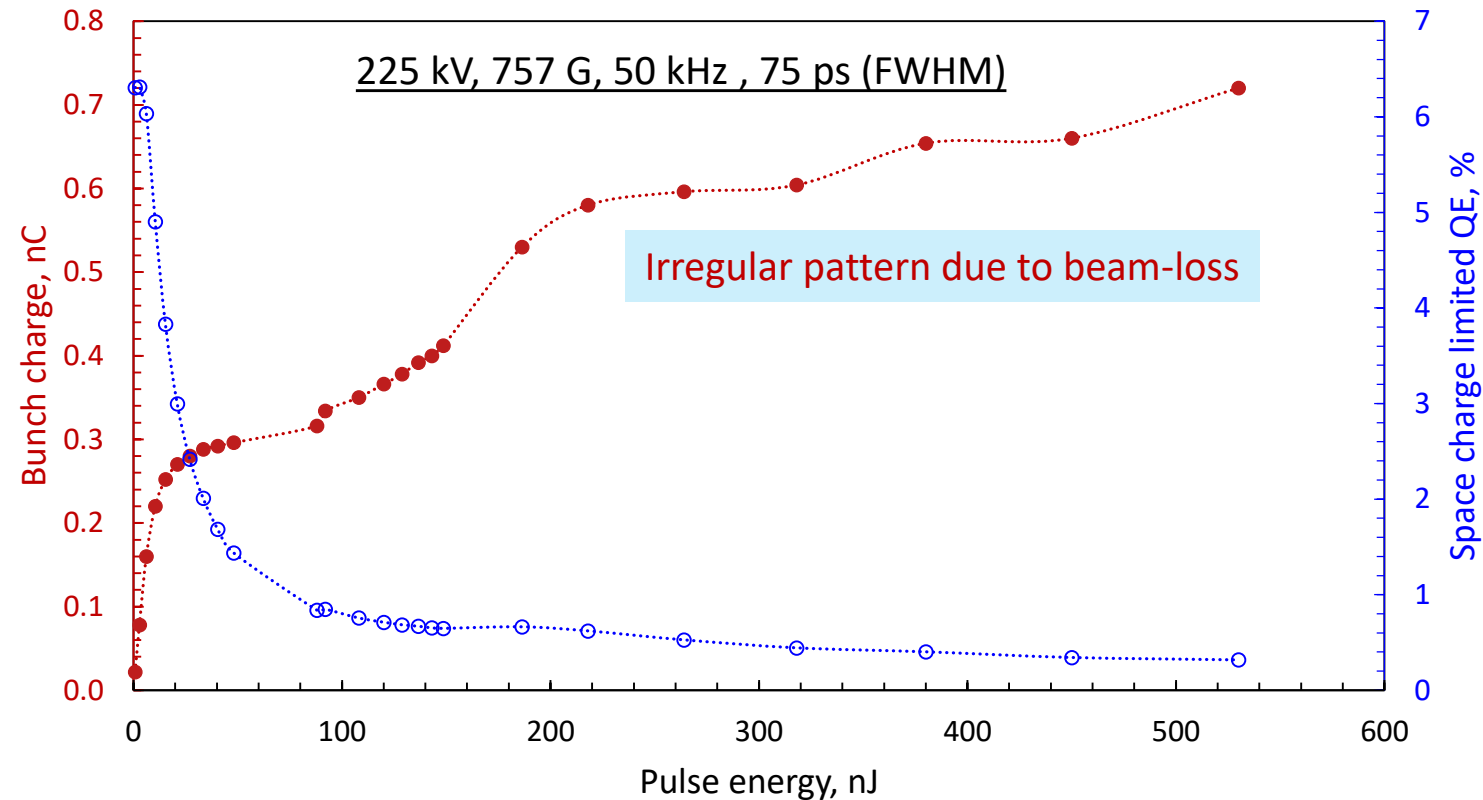

- Encountered space-charge-limited regime within 0.3 nC for different magnetized conditions
- Need longer laser pulses, higher gun voltage and better beamline optics to get nC bunches

High Average Current: 14 mA

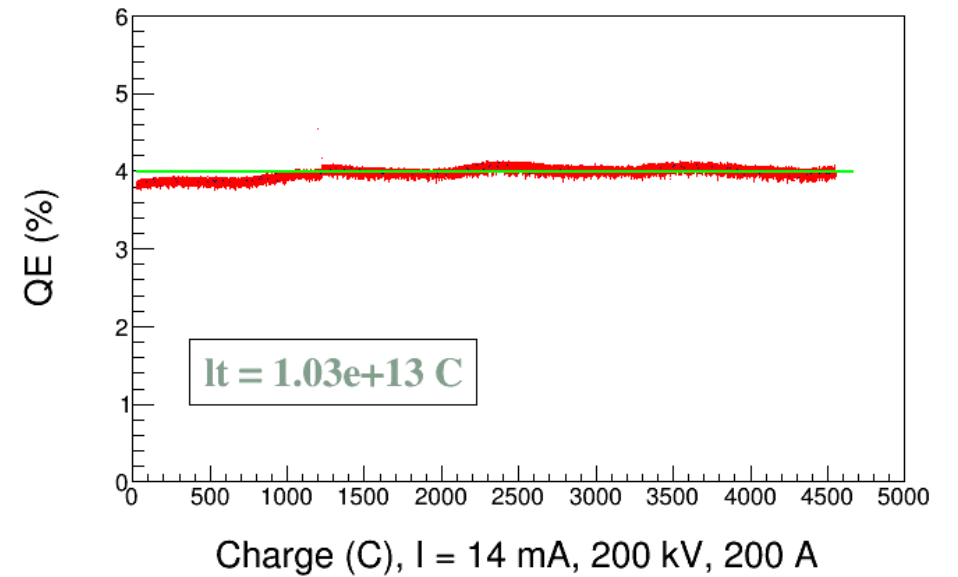
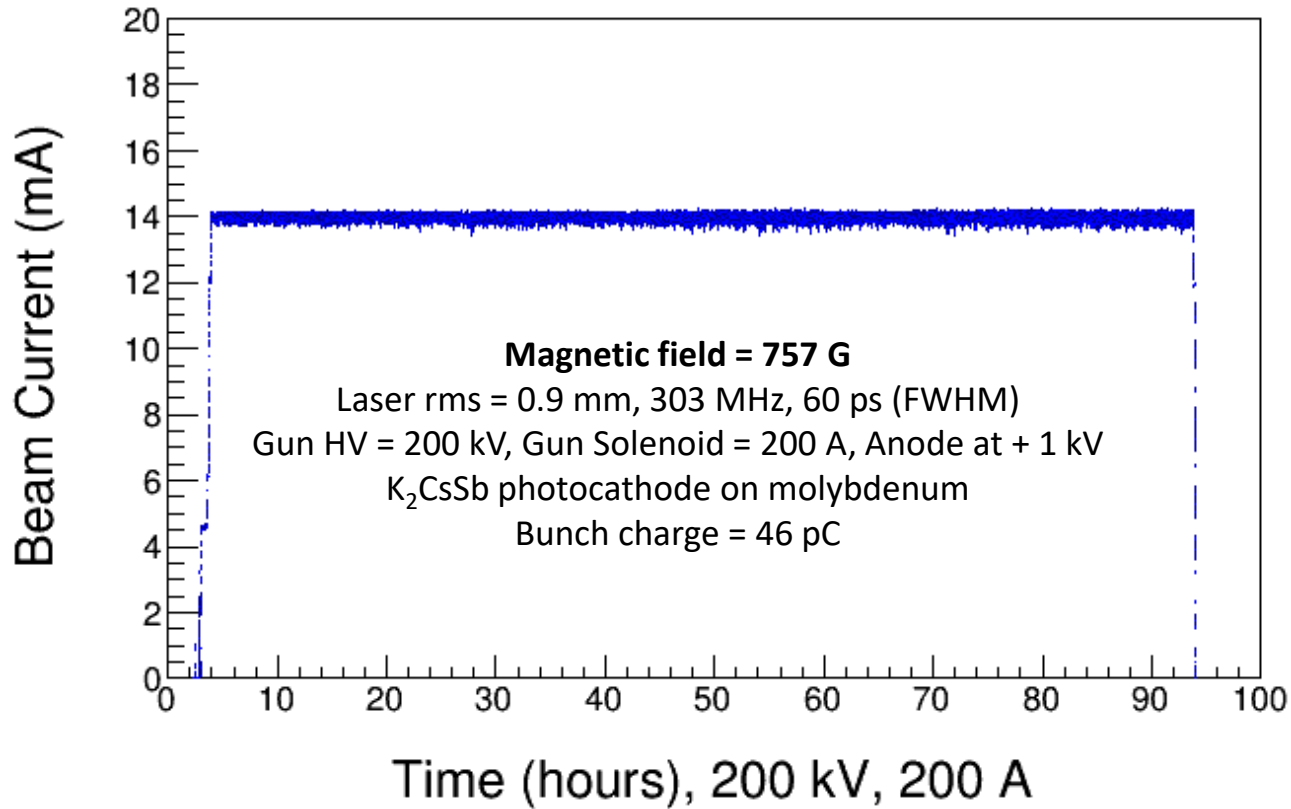

- No quantum efficiency (QE) reduction over 90 hour run
- Positive anode bias (+1 kV) effectively prevented ions in beamline from reaching gun and stopped micro-arcs and sudden QE loss (problem we struggled with)

High Average Current: 20 mA

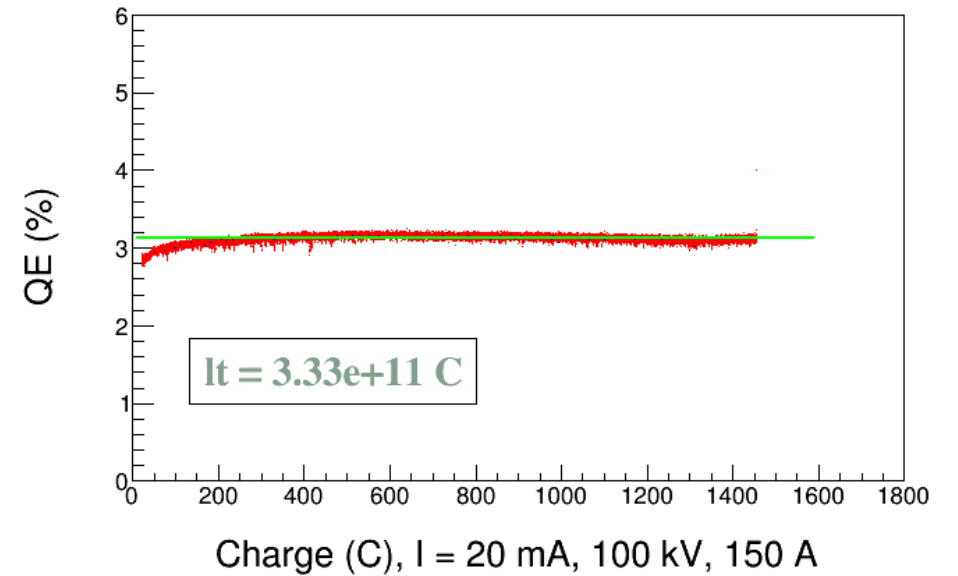
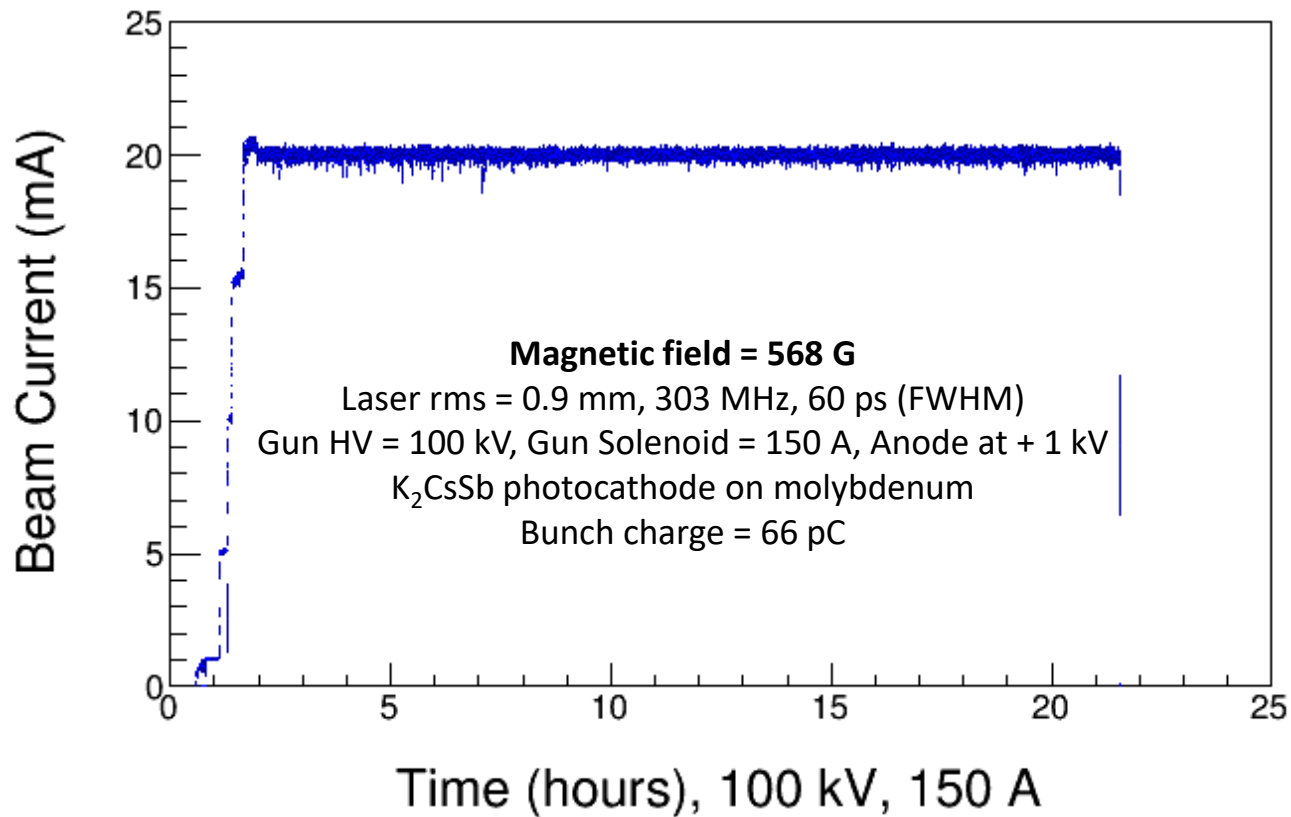

- No QE loss over 20 hours

High Average Current: 28 mA

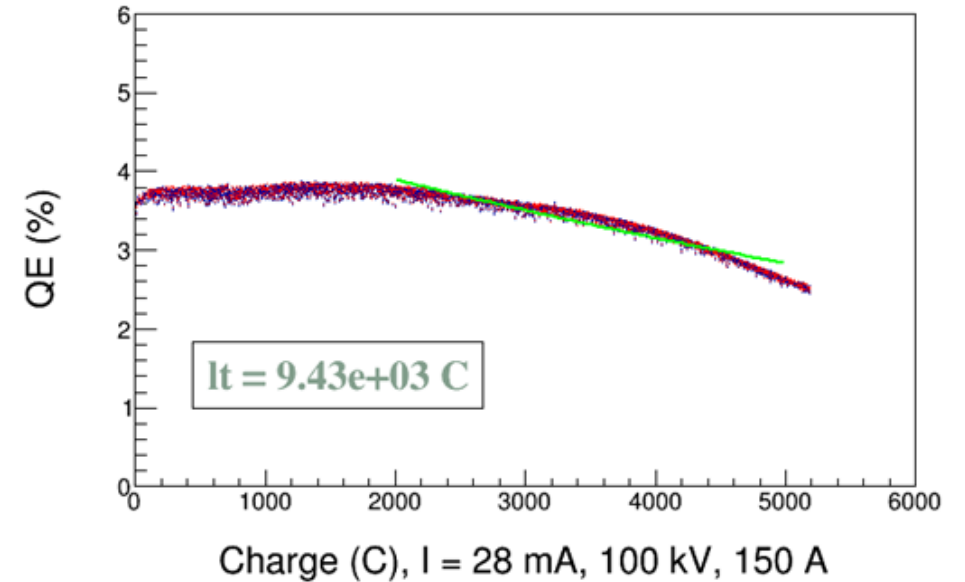
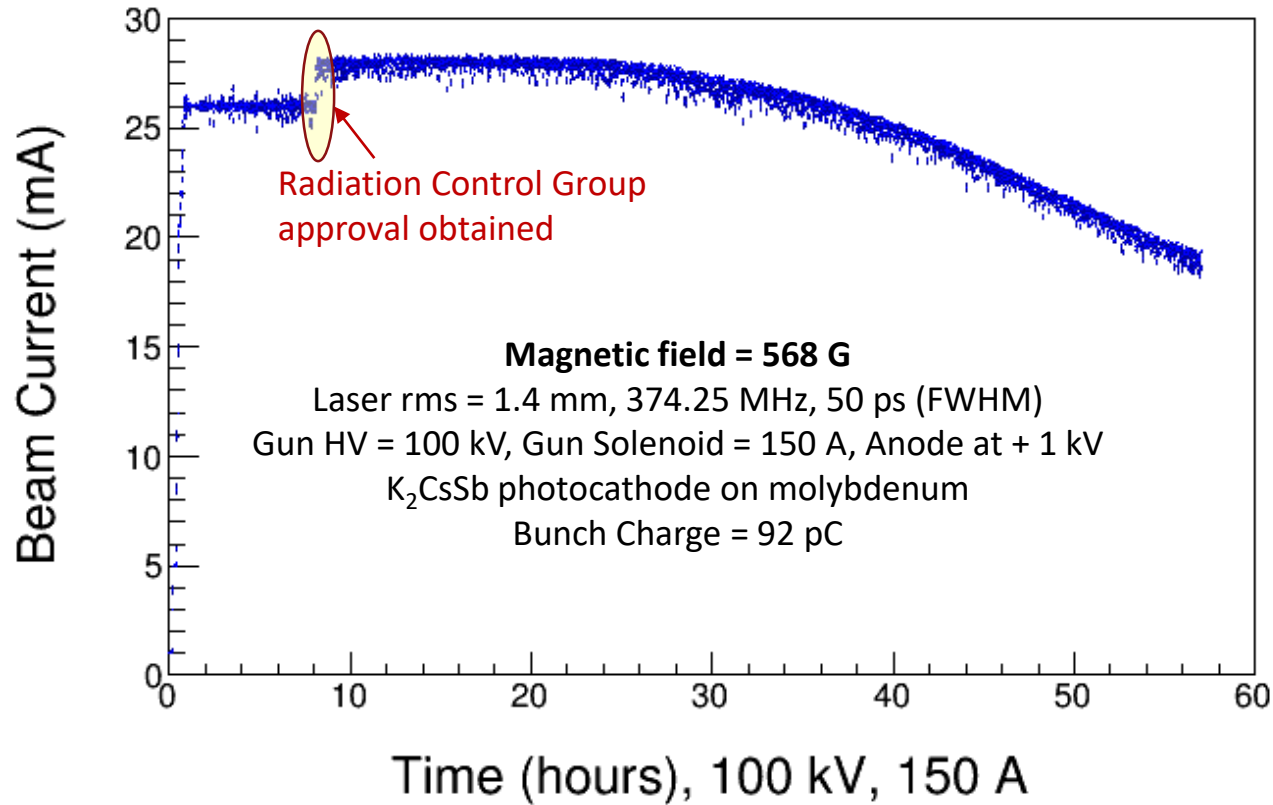

- Limited lifetime might be a result of heating and associated bandgap shift, or enhanced ion bombardment
- Will increase anode bias voltage beyond 1kV

Future Plans

- Swap photogun for RF-pulsed thermionic gun built by Xelera Research LLC to demonstrate magnetized beam at 65 mA and 125 kV (will use LDRD cathode solenoid and beamline but with new HV supply): an SBIR Phase II funded project (DE-SC0015186)
- Install two non-invasive magnetometer cavities – LDRD cavity and “Brock” cavity from Electrodynamics to measure beam magnetization: another SBIR Phase II funded project (DE-SC0017120)

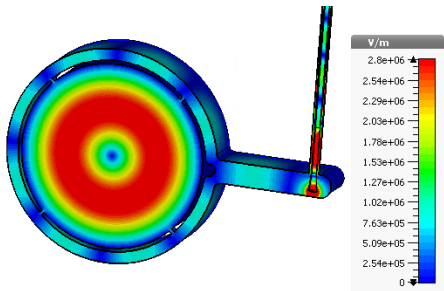

- Collaborate with Xelera, Electrodynamics, Brookhaven National Lab and others on more follow-up projects

Summary

- K_2CsSb photocathode preparation chamber, gun, cathode solenoid and beamline - all operational
- Photogun operated reliably up to 300 kV for >1000 h
- Have successfully generated and characterized magnetized electron beams
- Demonstrated high bunch charge up to 0.7 nC
- Delivered 28 mA magnetized beam (568 G at photocathode) with RF structure (gain-switched drive laser, 374.25 MHz, 50 ps FWHM) at 100 kV using 30 mA/225 kV HV supply with 3 kW limit
- Successfully fabricated alkali antimonide photocathode with QE ~ 9% on molybdenum substrate that provided long charge lifetime
- Positive bias on anode helps to prevent sudden QE loss from ion-induced micro-arcing events
- Envisioned new non-invasive device to measure beam magnetization (TE_{011} cavity). Cavity was designed and now under construction.

Thanks to those involved in this team work:

P. Adderley, J. Benesch, B. Bullard, J. Delayen, J. Grames, J. Guo, F. Hannon, J. Hansknecht, C. Hernandez-Garcia, R. Kazimi, G. Krafft, [M. A. Mamun](#), M. Poelker, M. Tiefenback, [Y. Wang](#), [S. Wijethunga](#), S. Zhang.