

Exploring the Quantum Universe

Pathways to Innovation and Discovery in Particle Physics

Report of the 2023 Particle Physics Project Prioritization Panel

Sally Seidel
26 April 2024
Nuclear Science Advisory
Committee Meeting



2023p5report.org



U.S. DEPARTMENT OF
ENERGY



The definition of Particle Physics has evolved with time.

- **Many kinds of experiments and facilities**
 - colliders of different energies
 - large-volume, low-noise targets for neutrinos and dark matter
 - cosmological observations: cosmic microwave background, matter distribution
 - “antennas” for certain kinds of dark matter
 - intense sources of particles to search for rare interactions
- **This report does not include particle astrophysics** --- astronomy with neutrinos --- but experiments can overlap
- **Neither do we include gravitational wave observatories**

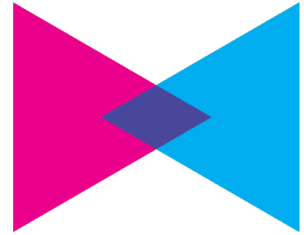

Energy Scales of Particle Physics

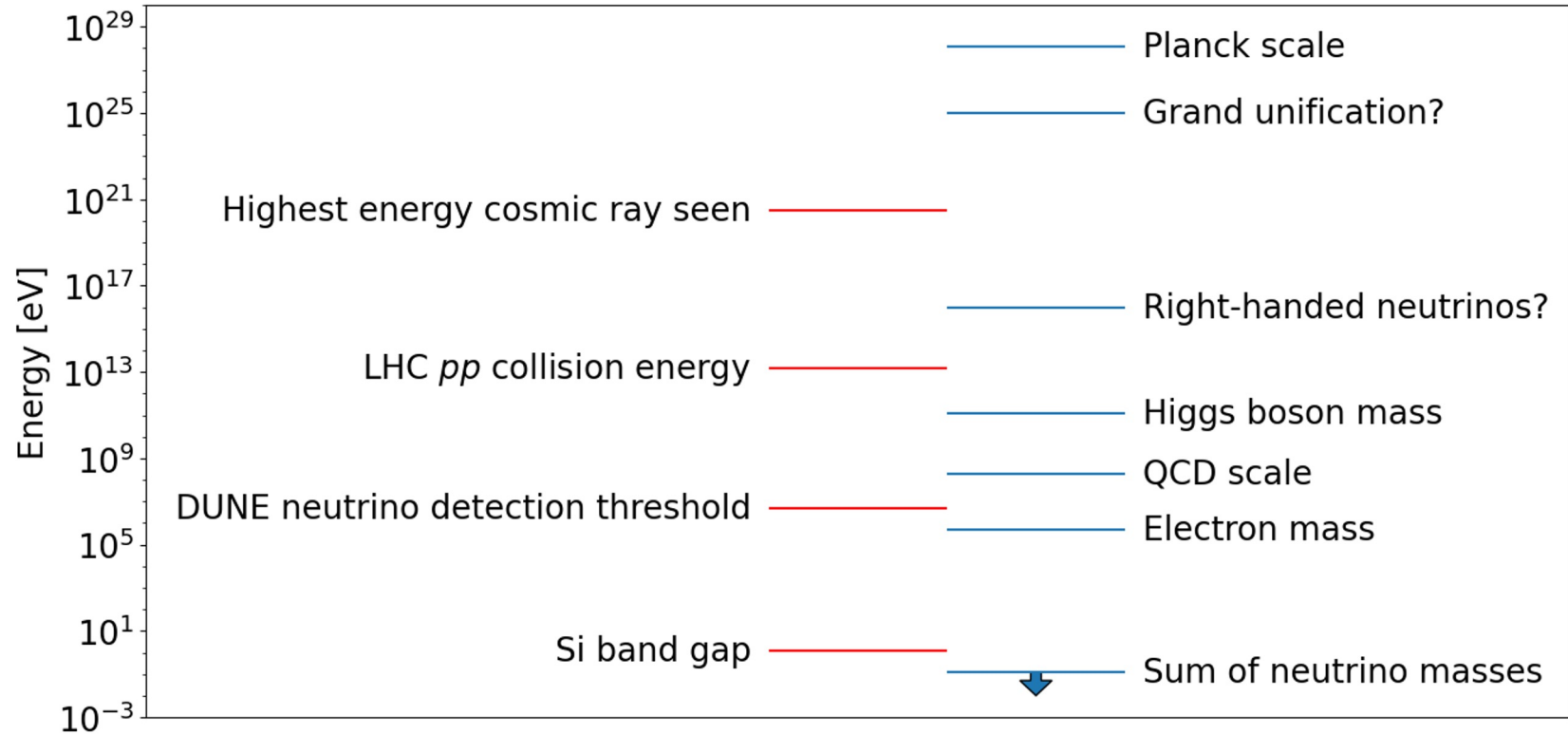

US Process for Future Planning

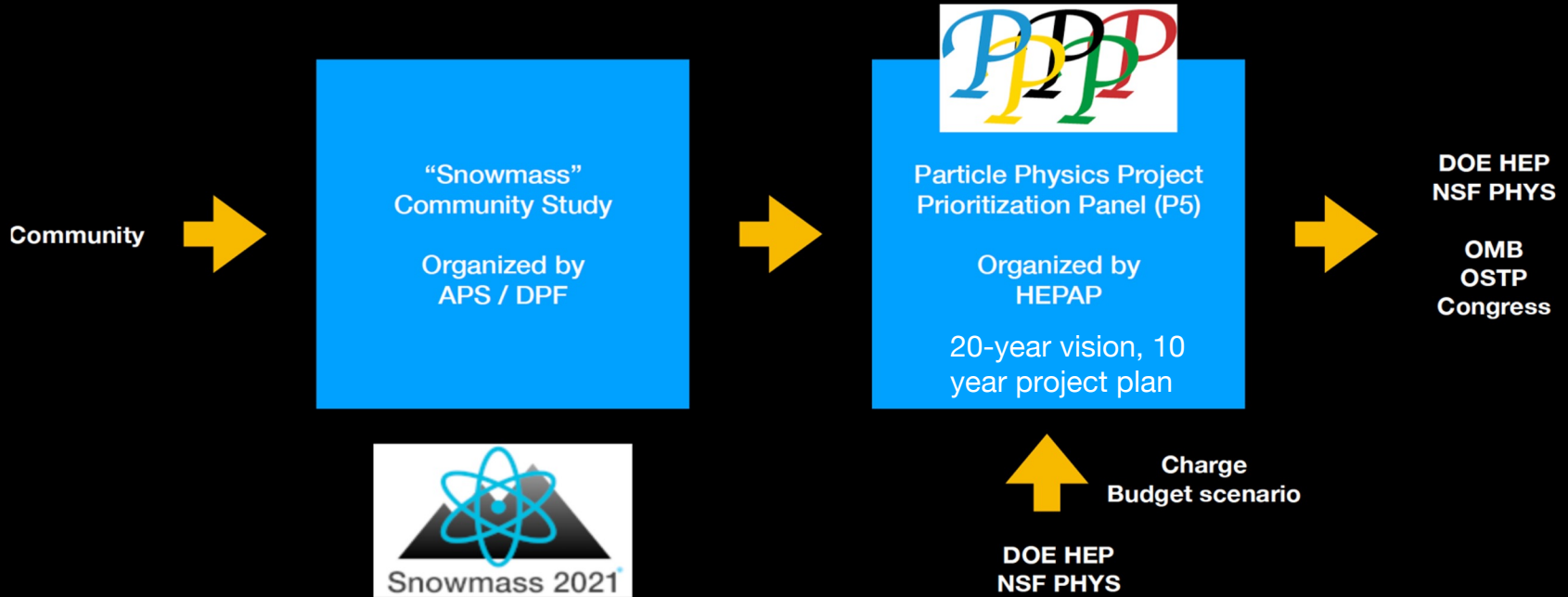

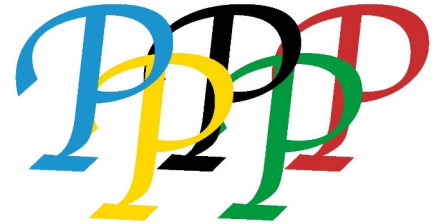

P5: The Particle Physics Project Prioritization Panel

- **Subpanel of the High Energy Physics Advisory Panel (HEPAP)**, which advises the Department of Energy and the National Science Foundation on issues related to theoretical and experimental particle physics & associated technologies - accelerators, advanced computing, etc.
- **P5 is created ~ once a decade and is charged with reviewing the science cases for, and prioritizing proposals for, projects over a ten year timespan - with a view to a longer-term future.**
- **P5 also makes other actionable recommendations for the health of the field**
- P5 takes **input from the Snowmass process, a community fact-finding and planning effort led by the APS Division of Particles and Fields**
- Analogous to a “decadal survey” or “long-range plan”
- The previous P5 report was released in 2014
- The **report described here** is available at <https://www.usparticlephysics.org/2023-p5-report/>



Prioritization Principles

Overall program should **enable US leadership in core areas of particle physics**

It should leverage **unique US facilities and capabilities**

Engage with **core national initiatives*** to develop key technologies,

Develop **a skilled workforce** for the future that draws on US talent

The field should **engage with and lead effectively in international endeavors**

- We **considered the uncertainties in the costs, risks, and schedule** as part of prioritization.
- The prioritized project portfolios were chosen to **fit within a few percent of budget scenarios** mandated by the federal agencies,
- The portfolio should ensure a reasonable **outlook for continuation into the second decade**, even though that is beyond the purview of this panel.

Balance program in terms of

- Size and time scale of projects
- On-shore vs off-shore
- Project vs Research
- Current vs future investment

*National initiatives are

- AI/ML
- Quantum Information Science
- Microelectronics

Prioritization principles are different for different sized experiments:

Large projects (>\$250M)

- Paradigm-changing discovery potential
- World-leading
- Unique in the world

Medium projects (\$50–250M)

- Excellent discovery potential or development of major tools
- World-class
- Competitive

Small projects (<\$50M)

- Discovery potential, well-defined measurements, or outstanding technology development
- World-class
- Excellent training grounds

Budgets

We had to consider plausible budgets for US funding (specifically, the DOE part):

- **Baseline:** as specified in the CHIPS and Science Act, then 3% increase per year in nominal terms (so assumed flat in real dollars)
- **Less favorable:** no CHIPS Act bump, 2% increase per year in nominal dollars (so steady decrease in real terms)

The budget cannot go only to building projects – it must *include funding students and postdocs, operating existing facilities, and so on*. The breakdown is roughly **30-30-40 for projects, operations, and research**.

Cannot do just only billion-dollar-scale projects!

- **Need pathfinder/demonstration experiments**
- **Need to train people** in all stages of the experimental lifecycle
- P5 recommends a dedicated, stable set-aside in DOE to fund middle-scale projects in all particle physics areas, with annual calls for proposals

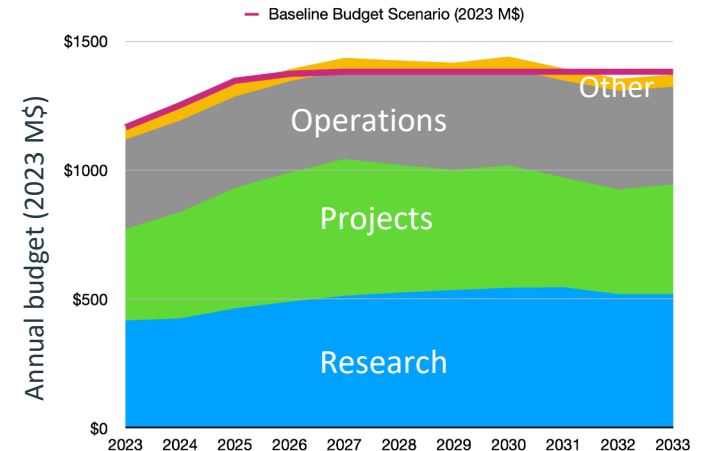

Difficult choices had to be made...

(Graph does not include an on-shore Higgs factory)

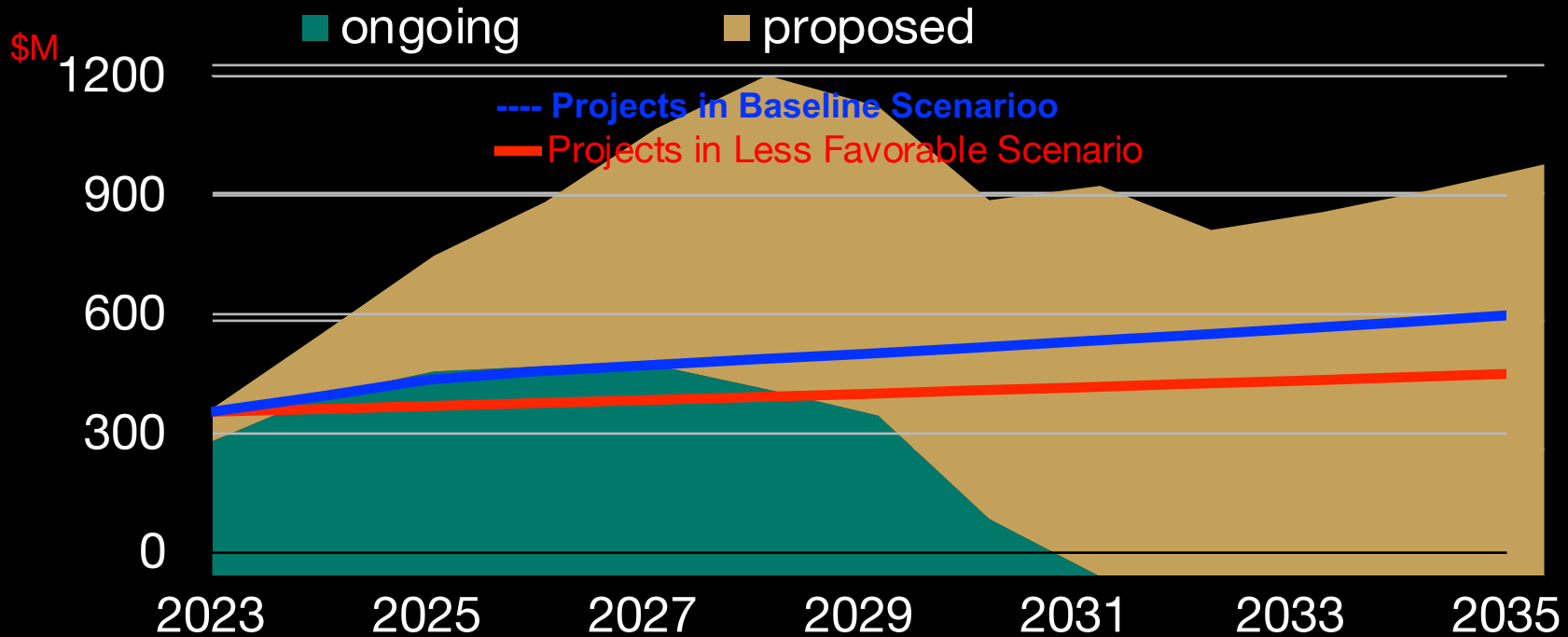

Global Considerations

Some projects *require* international collaboration to proceed – no single entity has the resources (budgetary, technical, personnel) to carry them out.

- CERN was the prototype for Europe, but now CERN itself needs to collaborate with other entities: e.g. the US is part of the Large Hadron Collider, and CERN is part of the US neutrino program.
- Negotiations cross multiple planning processes and treaty-level agreements

Yet many projects are reasonably within a single country's scope (of course international collaboration is still helpful)

- Panel considered: Are those projects competitive with proposals elsewhere for science and timeline? Do they feed into particular strengths of the US program (unique facilities, expertise)? Do they engage with US national initiatives? Will they be effective for workforce development?

Science Themes

To organize our thoughts we considered overarching “**science themes**”:

- ***Decipher the Quantum Realm***: we have fundamental particles (neutrinos and the Higgs boson) whose properties and nature are still somewhat mysterious. Is there more to say about them Beyond the Standard Model?
- ***Illuminate the Invisible Universe***: 95% of the energy of today’s universe is not explained by the Standard Model. Yet it is quite well described by adding “dark matter” and “dark energy” whose nature is not understood. Dark energy has similarities to what causes the “inflation” era right after the Big Bang. Can we find dark matter? Can we probe the evolution of dark energy? Can we measure the behavior of inflation?
- ***Explore New Paradigms in Physics***: Are there completely new particles and forces that we don’t know of? Are the parameters of the Standard Model accidental or do they reflect selection principles?

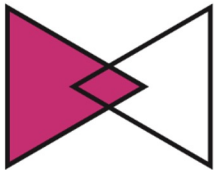
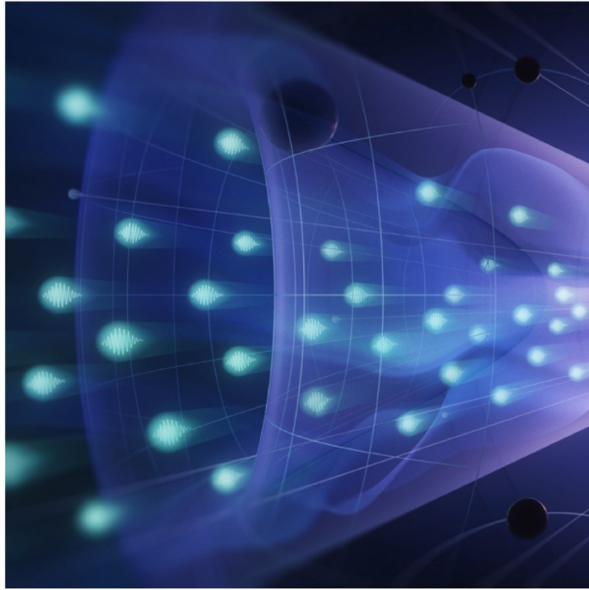

Decipher
the
Quantum
Realm

Elucidate the Mysteries
of Neutrinos

Reveal the Secrets of
the Higgs Boson

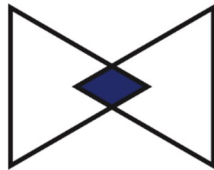

Explore
New
Paradigms
in Physics

Search for Direct Evidence
of New Particles

Pursue Quantum Imprints
of New Phenomena

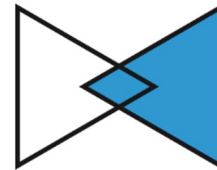
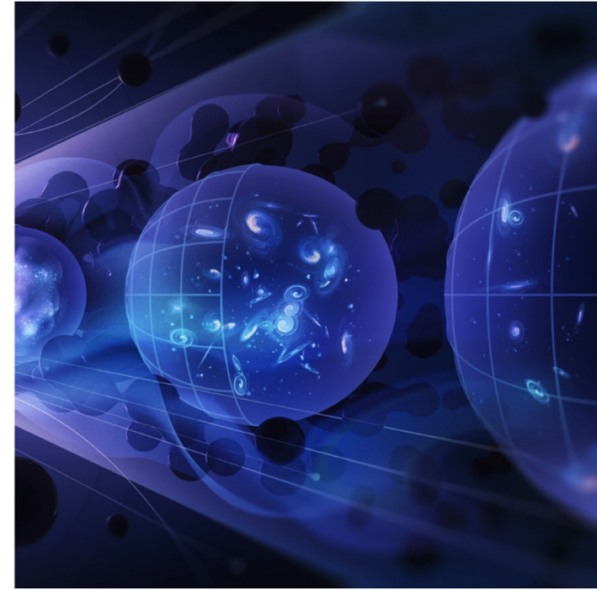

Illuminate
the
Hidden
Universe

Determine the Nature
of Dark Matter

Understand What Drives
Cosmic Evolution

Recommendations Overview

- The report includes **6 principal recommendations** associated with:
 - Elucidate the mysteries of neutrinos
 - Reveal the secrets of the Higgs boson
 - Determine the nature of dark matter
 - Understand what drives cosmic evolution
 - Search for direct evidence of new particles
 - Pursue quantum imprints of new phenomena
- It also includes **20 “Area Recommendations”**: theoretical, computational, and technological areas where sustained investments can advance the future of science and technology. These recommendations explicitly indicate the increase in annual funding needed to achieve the field’s 20-year goals.

Elucidate the Mysteries of Neutrinos

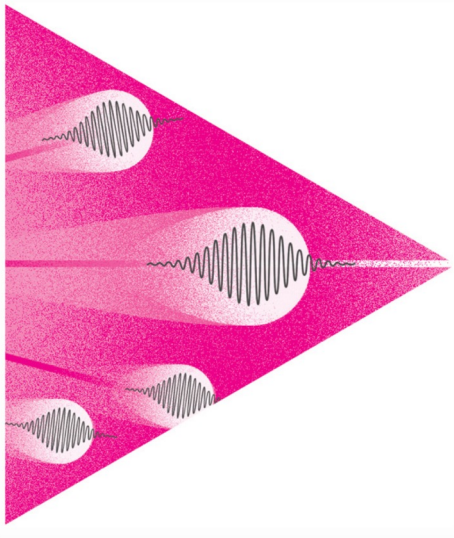

- What are the **masses** of neutrinos?
- What is the **mass ordering** of neutrinos? If inverted, might a new symmetry be needed to account for two heavier neutrinos having similar masses?
- Are neutrinos **their own antiparticles**? Can this help us explain the matter-dominated universe we are in?
- Do antineutrinos oscillate differently than neutrinos? (Is **CP symmetry violated**?) Can this explain the matter-dominated universe we are in?
- What astrophysical phenomena can neutrinos open to us?

Top Priority: Complete Ongoing Experiments

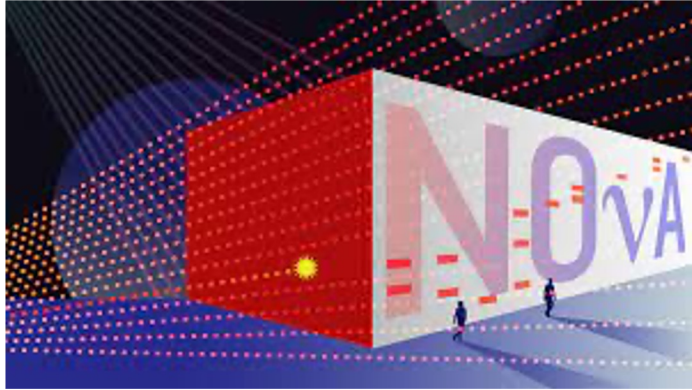

- Nova and T2K have pioneered electron neutrino and antineutrino appearance observations.
- They have contributed to dealing with systematic uncertainties for mass ordering, CP violation, and mass mixing parameter measurements.
- The Short Baseline Neutrino program has explored numerous anomalous results and proved crucial in maturing liquid argon technology and analysis.

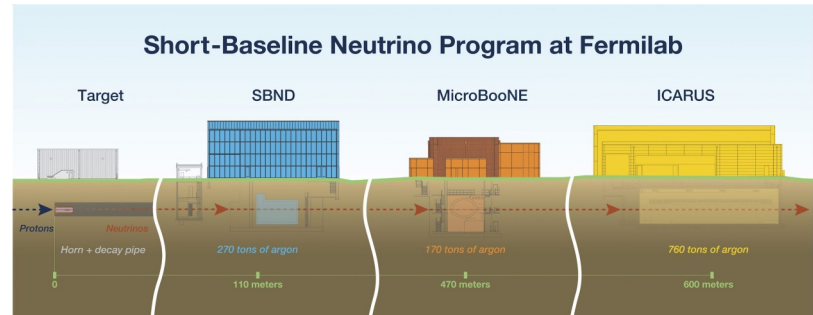
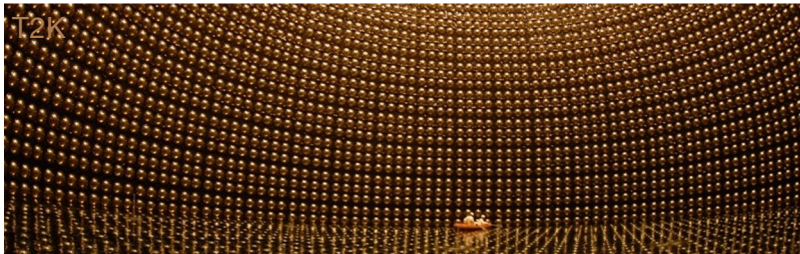

Top Priority: Complete LBNF/DUNE Phase I

DUNE Phase-I:

- Two 10 kt LAr TPCs at Sanford Underground Research Facilities (SURF).
- A near detector facility, illuminated by the world's brightest neutrino beam.
- The PIP-II accelerator upgrade under construction, which will enable a 1.2 MW proton beam.
- First goal: Mass ordering, with some sensitivity to the CP-violating phase.
- Also, sensitivity to electron neutrino component of a supernova burst.

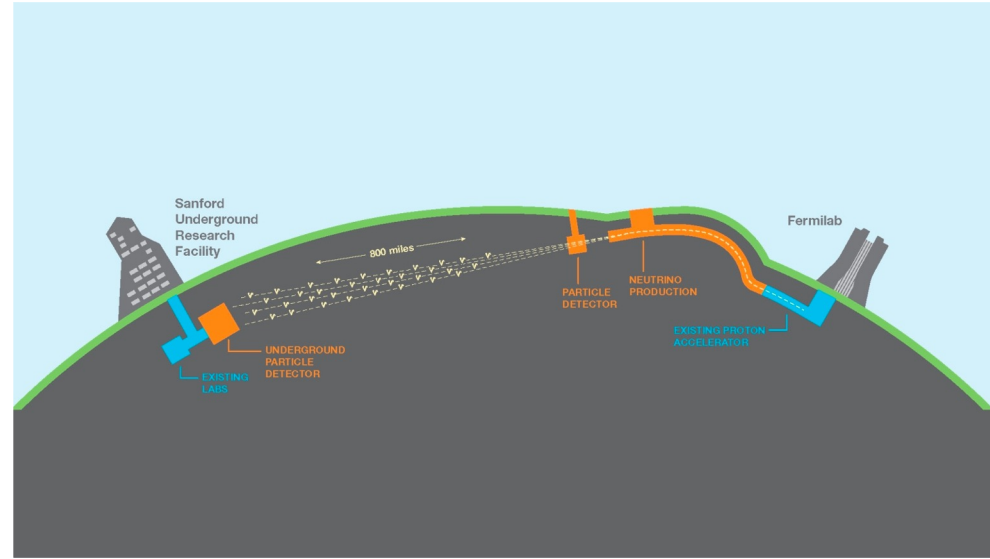

normal hierarchy (NH)

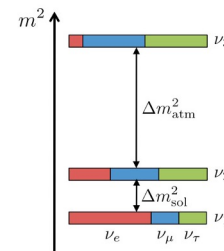

inverted hierarchy (IH)

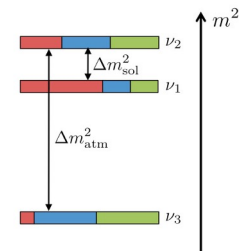

Major Project this decade: DUNE Phase II

- Include an early implementation of Fermilab Accelerator Complex Evolution – Main Injector Ramp & Targetry (ACE-MIRT) project, with the enhanced 2.1-MW beam.
- A third far detector at SURF.
- An upgraded near detector complex to aid in controlling systematics and search for BSM physics.

Science goals:

- Most precise measurement of the CP phase across a range of possible CP phase space
- Search for signatures of unexpected neutrino interactions.
- Study direct appearance of tau neutrinos.

Fermilab accelerator complex:

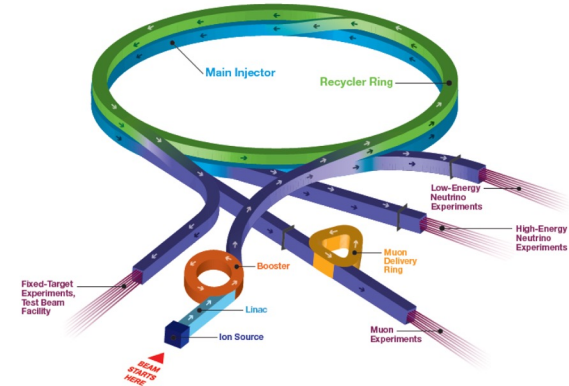

Inside a Liquid Argon TPC:

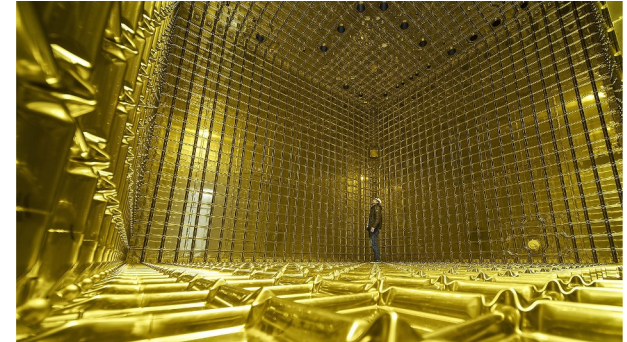

Reveal the Secrets of the Higgs Boson

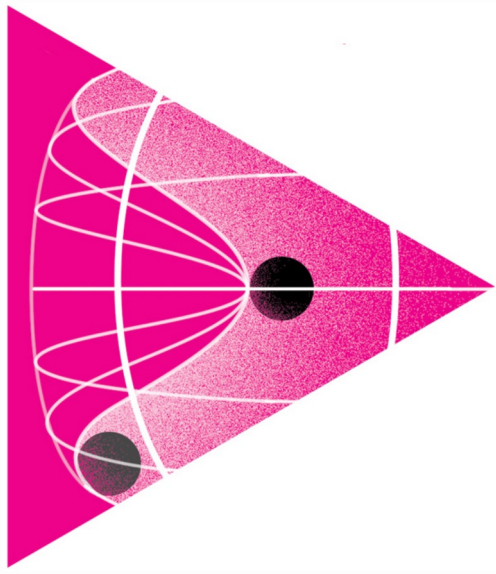

- The properties of the Higgs field are connected to **many fundamental questions in particle physics**, and as the only known fundamental field with a non-zero value in the vacuum state, it is unique.
- Is the Higgs field **fundamental**?
- Is there only one Higgs boson, or is there a **richer sector** containing related particles with new dynamics?
- **How can the Higgs mass be so low** - are there additional particles with similar masses to stabilize it?
- What is behind the **huge range of coupling strengths** to the Higgs in the Standard Model?

Higgs Boson: At the Center of the Standard Model

- The SM predicts that the Higgs field is connected to mass generation of all fundamental particles through its vacuum expectation value.
- The SM invokes the simplest possible Higgs field (a fundamental weak doublet). Could the field be **more complicated**? Could it be a condensed **composite** of other, actually fundamental particles?
- The Higgs field **self-interaction** (how it gives itself mass) has not been measured yet. In more complex models than the SM, the related phase transition could drive the creation of the universe's **matter-antimatter asymmetry**.
- By virtue of its quantum numbers and being a scalar, the Higgs could **interact with particles beyond the Standard Model** at tree level (the *Higgs portal*). Any evidence of this?

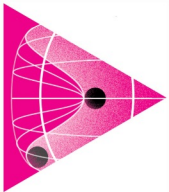

Top Priority: Complete the Ongoing ATLAS and CMS Experiments at the LHC

CMS

Preliminary

138 fb⁻¹ (13 TeV)

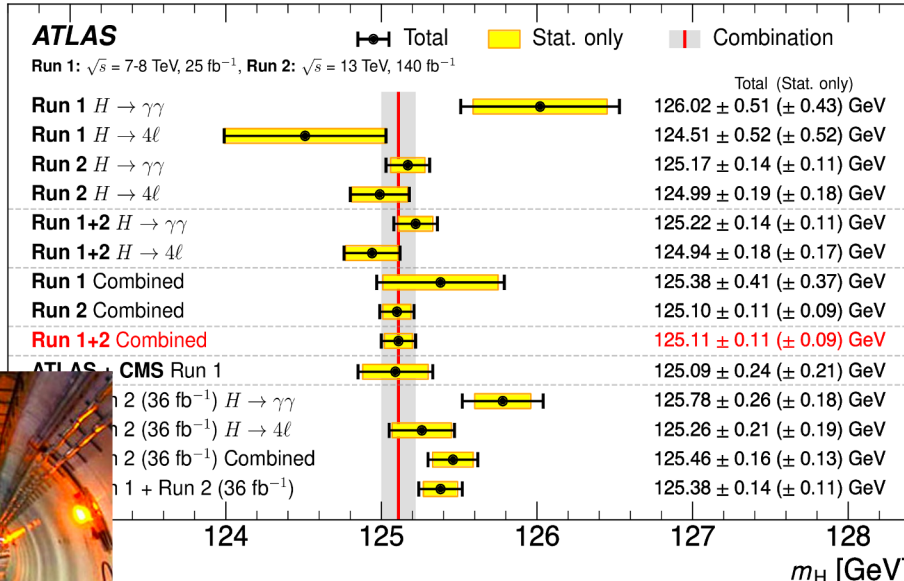
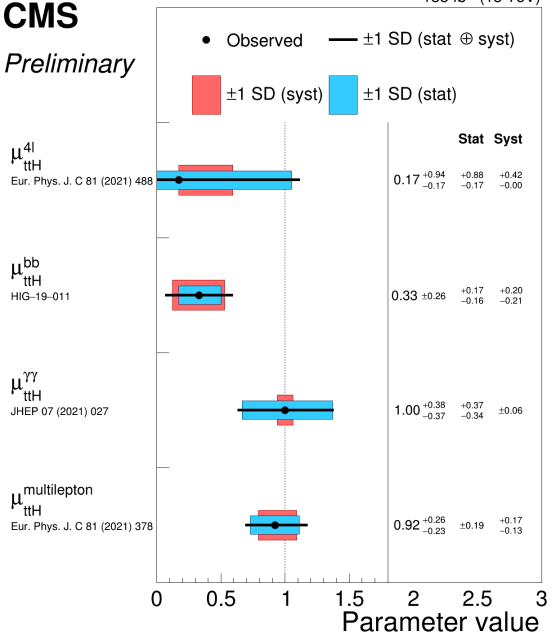

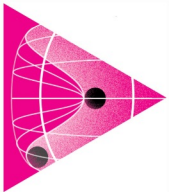

Top priority: Complete the High Luminosity (HL) LHC*

Higgs boson measurements planned:

- SM couplings measured to few percent, or lower, for many particles.
- Increased sensitivity to BSM physics.
- Probing of Higgs potential: how strongly does the Higgs boson couple to itself?

*Operation beginning in 2029. Ten times the integrated luminosity of the LHC. Center of mass energy 14 TeV. Number of collisions per crossing will be > 5 times that of the nominal LHC design.

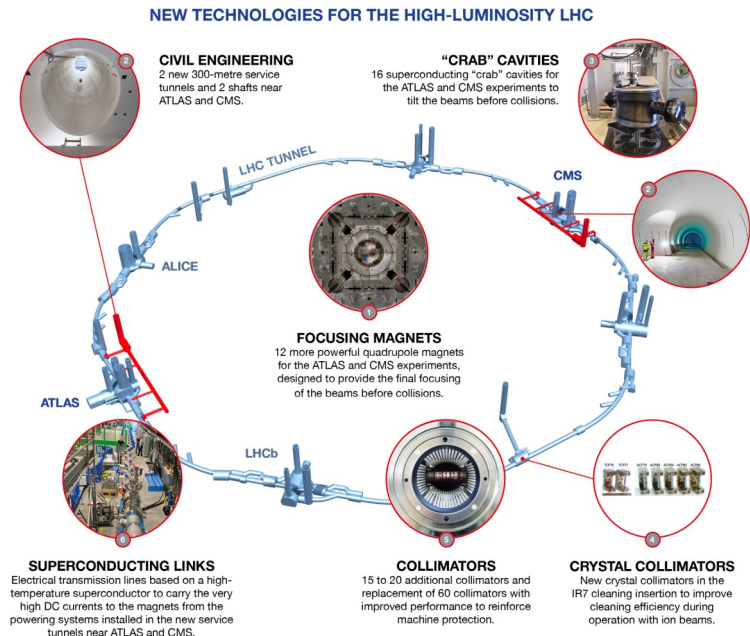

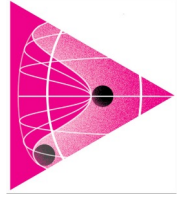

Recommended Major Project: Higgs Factory

- Define a “Higgs Factory” as an **electron-positron collider** that can cover the range of collision energies from **90 GeV** (Z production) to **350 GeV** (top quark pair production)
- Very clean environment -> **order of magnitude improvement over LHC** in important Higgs boson measurements
- Precision measurements of Higgs couplings and production modes.
- Increased access to invisible decays of Higgs
- Higgs factories are large machines:
 - Circular collider needs to be very big due to electrons’ synchrotron radiation as they are accelerated in a circle
 - Linear collider needs to be long since the electrons are accelerated in one shot
- Depending on models, Higgs measurements sensitive to new physics at up to 10 TeV scale

P5 recommends a Higgs Factory, to be built outside the US. The specific design is to be chosen later this decade.

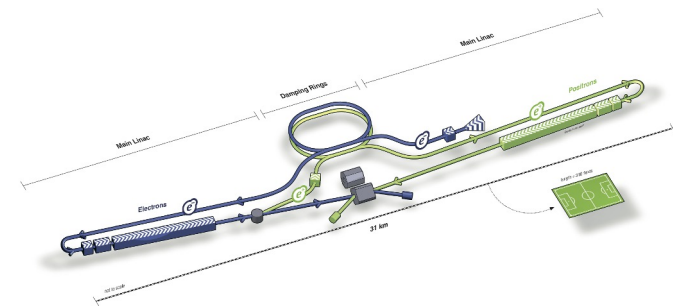
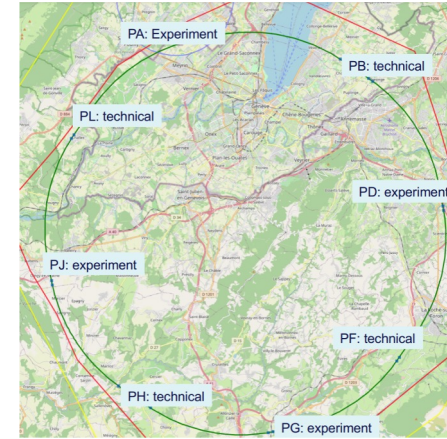

Recommended Long Term R&D: 10 TeV pCM Collider

Precision measurement of the shape of the Higgs potential requires collision energies \sim an order of magnitude beyond LHC.

Since protons are not fundamental - LHC really collides quarks and gluons, at an effective energy of ~ 1 TeV - a collider of electrons or muons reaches the same effective parton-level collision energy with much lower overall energy - **10 TeV vs. 100 TeV: thus a smaller machine.**

Reaching 10 TeV pCM is a **technical and budgetary challenge.**

- **protons:** reuse e.g. 91 km LHC-ee ring, but still need (many) high field magnets that don't exist yet
- **electrons:** standard acceleration technologies would require an accelerator of hundreds of km. Wakefield technologies may be transformative.
- **muons:** unstable, half life $2.2 \mu\text{s}$ - need to produce, trap, condense, accelerate them quickly. But collider circumference could be ~ 10 km.

P5 recommends R&D towards all these possibilities.

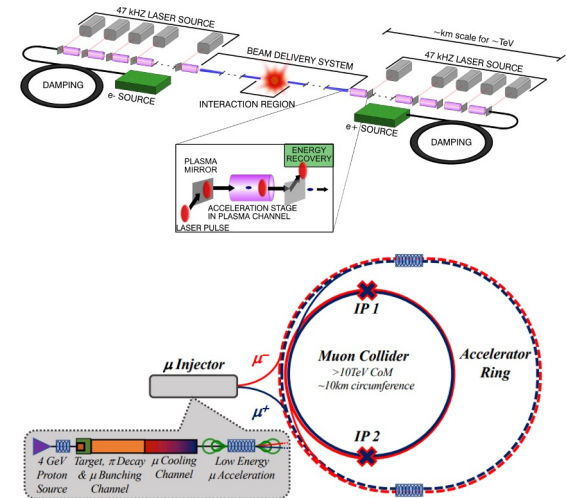
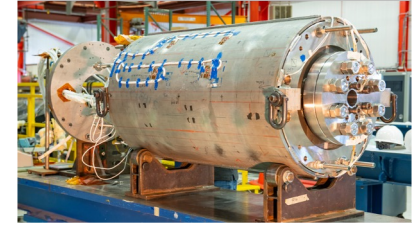

Determine the Nature of Dark Matter

- Dark matter constitutes the majority of the universe's mass, but its interactions beyond gravity remain unknown.
- Cosmic Surveys: probe the distribution of dark matter on a variety of length scales.
- Accelerator-based experiments: attempt to produce dark matter particles.
- Direct detection: focuses on detecting dark matter's interactions here on Earth.
- Indirect detection experiments: look for cosmic messengers resulting from dark matter interactions.

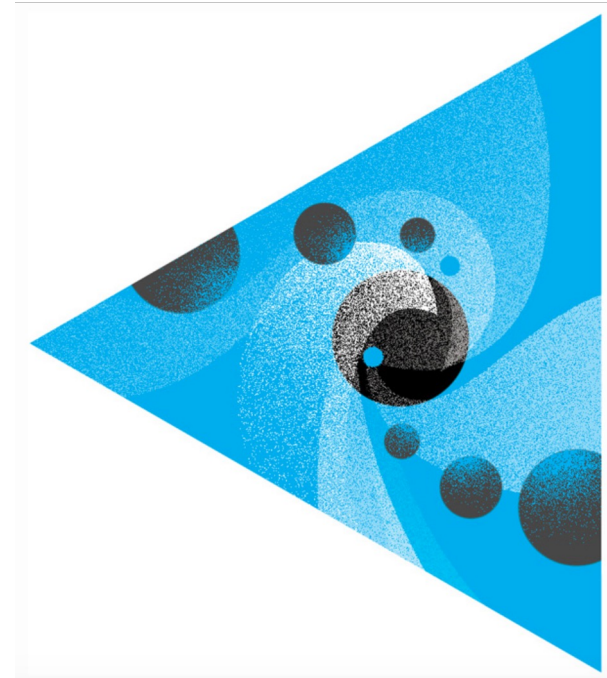

Existing Efforts

- Second Generation *direct detection experiments*
 - nuclear recoils in noble liquid detectors (xenon and argon) and nuclear/electron/phonon recoils in semiconductors
 - axion \rightarrow photon conversion in magnetic fields
- Smaller experiments with *other targets* (CCDs, bubble chambers, scintillator crystals)
- *Indirect detection* through dark matter annihilation/decay in astrophysical sources, detected through cosmic rays

LZ

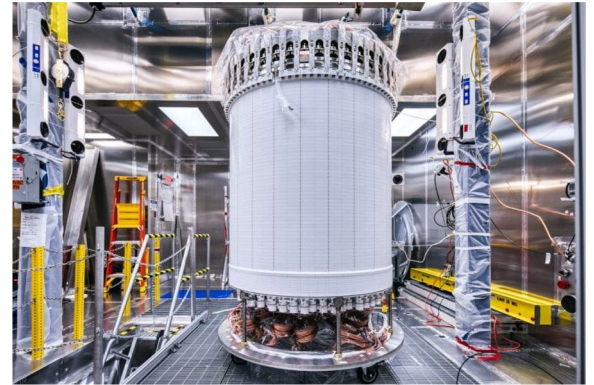

ADMX

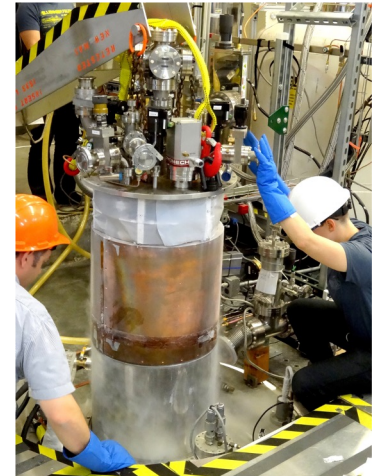

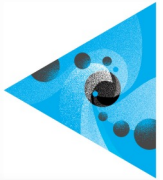

Top Priority: Complete Ongoing Experiments

LHC: could produce electroweak-scale DM



LZ

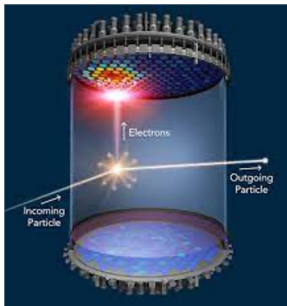

XENONnT



Darkside 20k

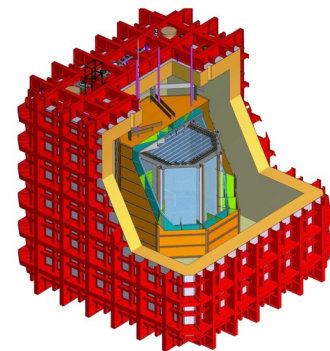

IceCube Lab

sensitive to ultra heavy DM

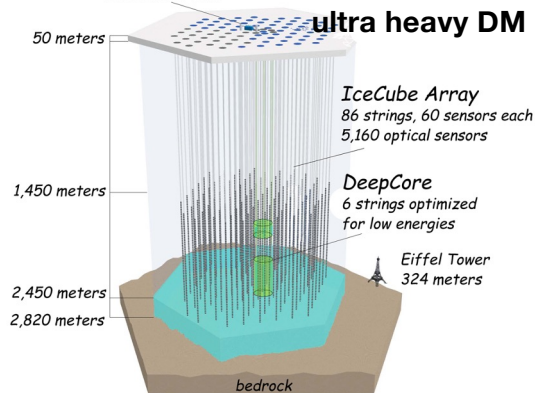

ADMX-G2

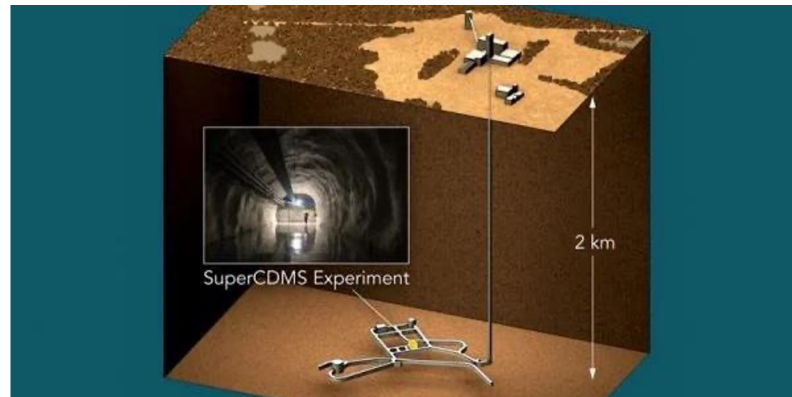

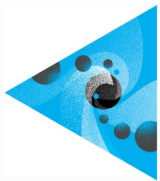

Recommended Major Project: Third Generation (“G3”) Direct Detection Experiment

For WIMP detection: The scalable detection technology is liquid noble gas time projection chambers, using xenon or argon, situated in underground facilities.

With the G3 experiments we aim to improve sensitivity further, until neutrino backgrounds become important (the neutrino *floor* or *fog*).

P5 recommends US participation in a G3 dark matter experiment, preferably sited in the US (at Sanford Lab, the same location as DUNE).

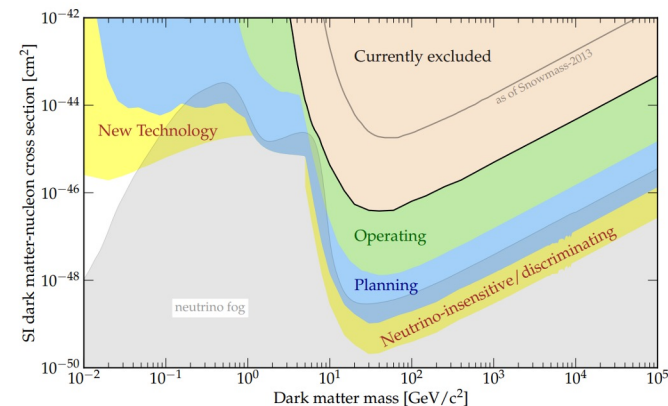

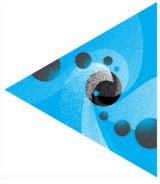

Recommended Mid-scale Projects

- Broad range of parameter space beyond the WIMP paradigm, much of it only barely touched. Significant progress can come from tabletop experiments.
- Specific motivation to look for axions: to understand why there is no neutron electric dipole moment.
- Include extremely light dark matter particles.
- Attempt to detect dark matter indirectly through astroparticle signatures: neutrinos from decaying heavy DM (IceCube-Gen2) or cosmic rays from dark matter self-annihilation (Cherenkov Telescope Array, Southern Wide-Field Gamma-Ray Observatory)

P5 recommends a significant investment in an “agile” portfolio of mid-scale projects (including but not limited to dark matter searches).



Understand What Drives Cosmic Evolution

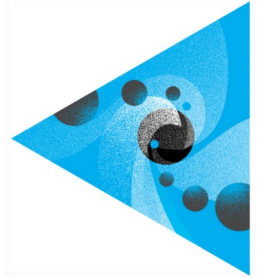

Dark Energy: Inflating the Universe

70% of the energy of the universe at the current time is “dark energy”: approximately 4 keV for every cm^3 of the universe. This energy density seems to stay constant as the universe expands, creating a negative pressure and causing the expansion to accelerate.

Separately, the relative homogeneity of the universe leads us to think there was a brief period of hyper-expansion of the universe just after the Big Bang, called inflation. Usually we associate this with the *inflaton* field). What are its properties?

- We model this with a pure Einsteinian cosmological constant term Λ (just a constant general relativity parameter); is this correct? Can we trace the strength of dark energy over the history of the universe?
- What are the properties of the inflaton?
- Is there a connection between the two types of cosmic acceleration, dark energy and inflation?

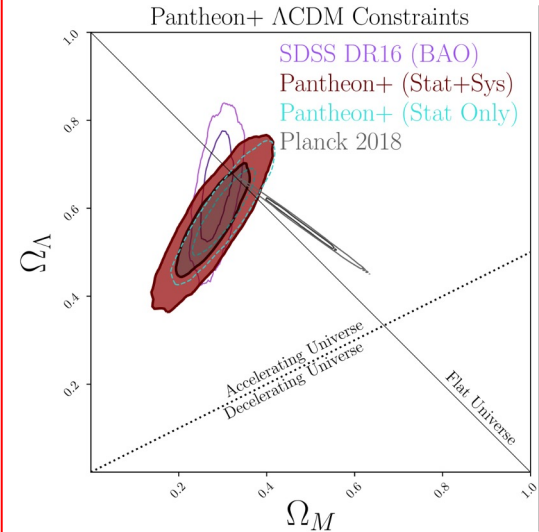

Brout et al., *ApJ* 938, 2

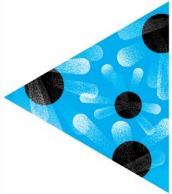

Since Previous P5

A suite of experiments (BICEP, South Pole Telescope (SPT), Atacama Cosmology Telescope (ACT) POLARBEAR, and the European Planck Satellite) have given us crucial bounds on:

- the energy scale of inflation
- the abundance of light relics in the early universe
- the sum of neutrino masses.

Progress has been made in developing experimental techniques, improving technologies, and strengthening our understanding of systematic uncertainties.

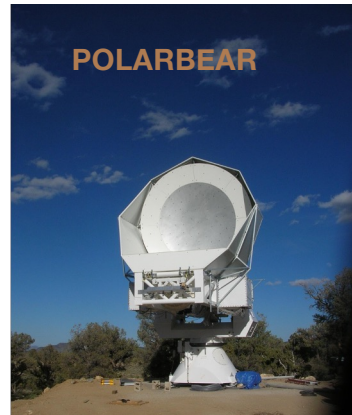
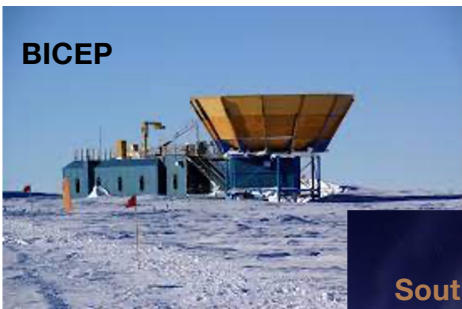

Ongoing: Rubin-DESC

- The Dark Energy Science Collaboration is one of the groups studying data from the Rubin Observatory's Legacy Survey of Space and Time (LSST).
- Telescope will image entire sky every few nights.
- Dark energy science: gravitational lensing, galaxy clustering, and type 1a supernovae to map cosmic acceleration.

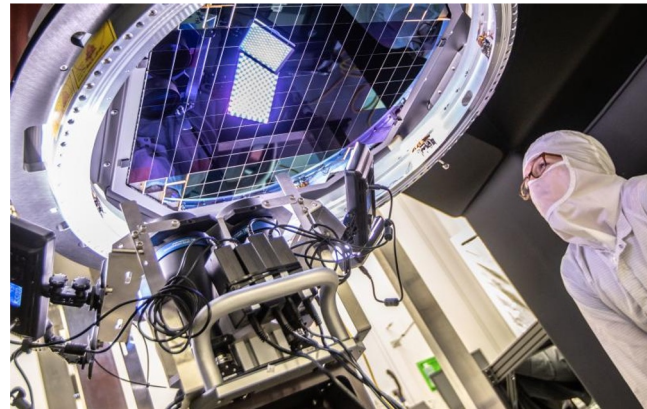

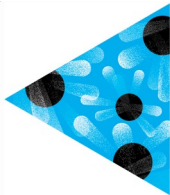

Recommended Major Project: CMB-S4

This is a “Stage 4” experiment to measure the features of the cosmic microwave background precisely. Involves telescopes at the South Pole and in Chile making extremely precise measurements of the CMB at many frequencies.

Follows ongoing ground-based program of South Pole Observatory and Simons Observatory

- CMB-S4 will start to be sensitive to **primordial gravitational waves** produced during inflation, in an important class of models.
- It is also sensitive to **dark radiation** - unknown relativistic particles produced in the early universe.
- The **gravitational lensing** of the CMB by foreground matter will give information on dark matter and energy.

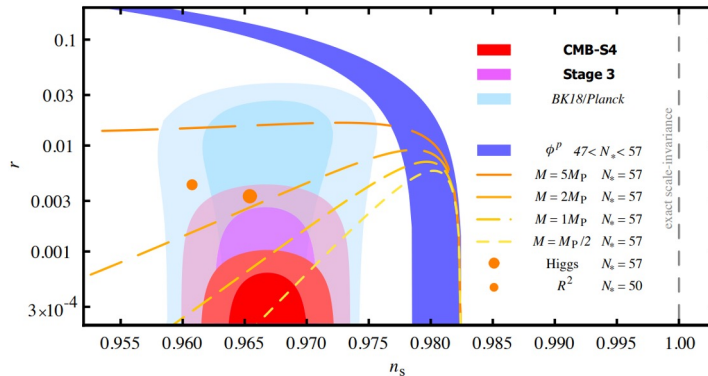
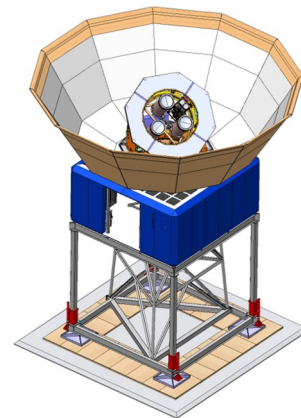

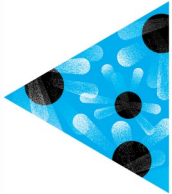

Science at the South Pole

- Sensitivity to the physics of inflation is high at the South Pole.
- The atmosphere is dry and stable, and continuous observation of the same patch of sky is possible.
- A successful CMB-S4 will require coordination between
 - DOE-HEP
 - NSF-AST
 - NSF-OPP

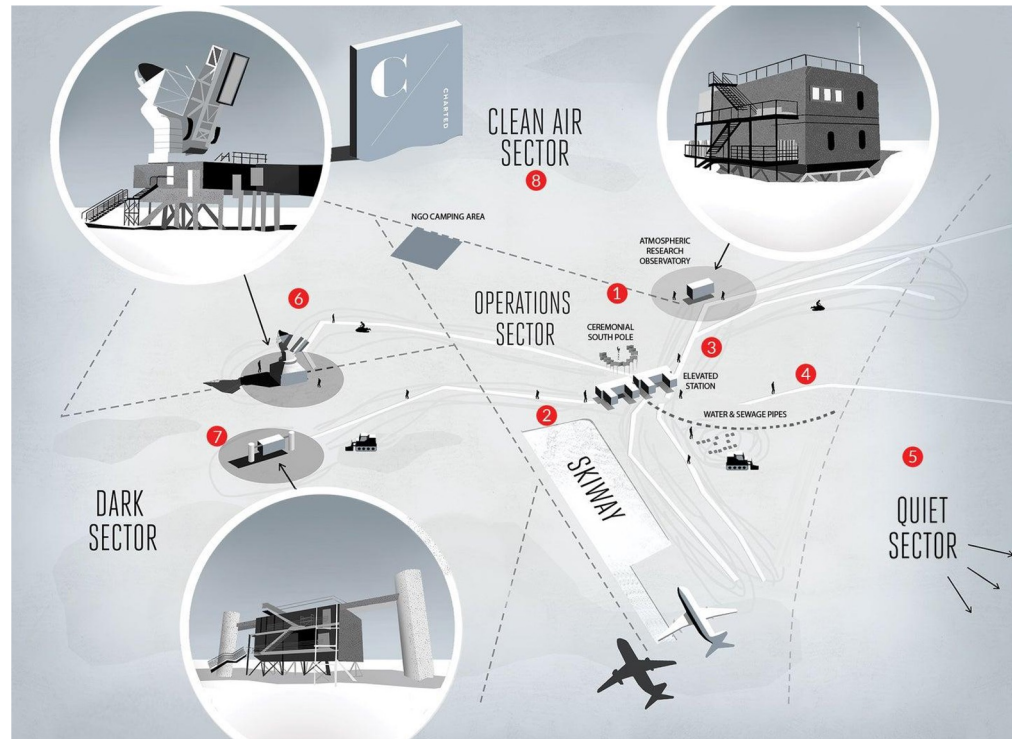

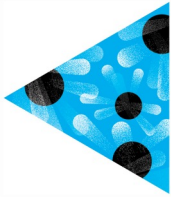

Recommendation: Spectroscopic Surveys

- Producing 3D maps of matter distribution in the universe is complementary to studying the cosmic microwave background, e.g. it can probe the evolution of dark energy since the CMB era.
- *P5 recommends continued operation of the DESI spectroscopic survey, and its upgrade (DESI-II) which will focus at higher redshift ($z > 2$).*
- Also serves as a bridge to the next generation spectroscopic experiments (Spec-S5), demonstrator of certain technologies.
- In the farther future, the “line intensity mapping” technique may be able to determine mass distributions at different redshifts without resolving the sources explicitly.

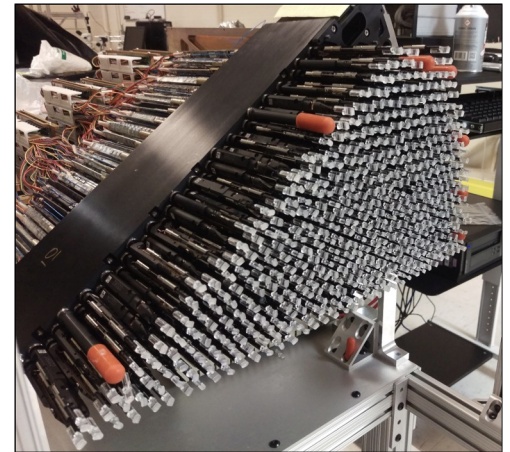
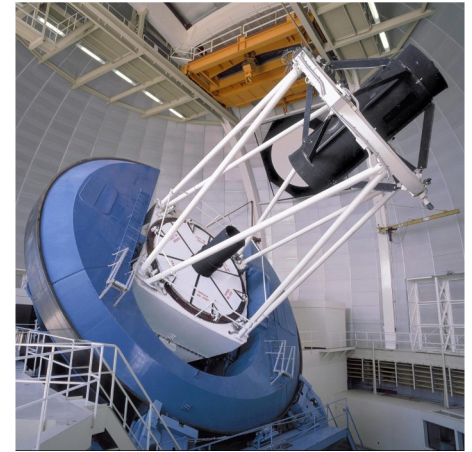

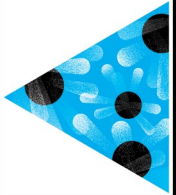

Galaxy survey and CMB outlook: beyond DESI, Rubin/LSST

2023 P5 report recommends:

- projects that hit key scientific milestones:
- CMB-S4
- DESI-II
- R&D towards Spec-S5 (→mature project concept for next P5 in baseline budget)
- R&D for Line Intensity Mapping
- Expanded theory support for the particle physics case for gravitational wave facilities

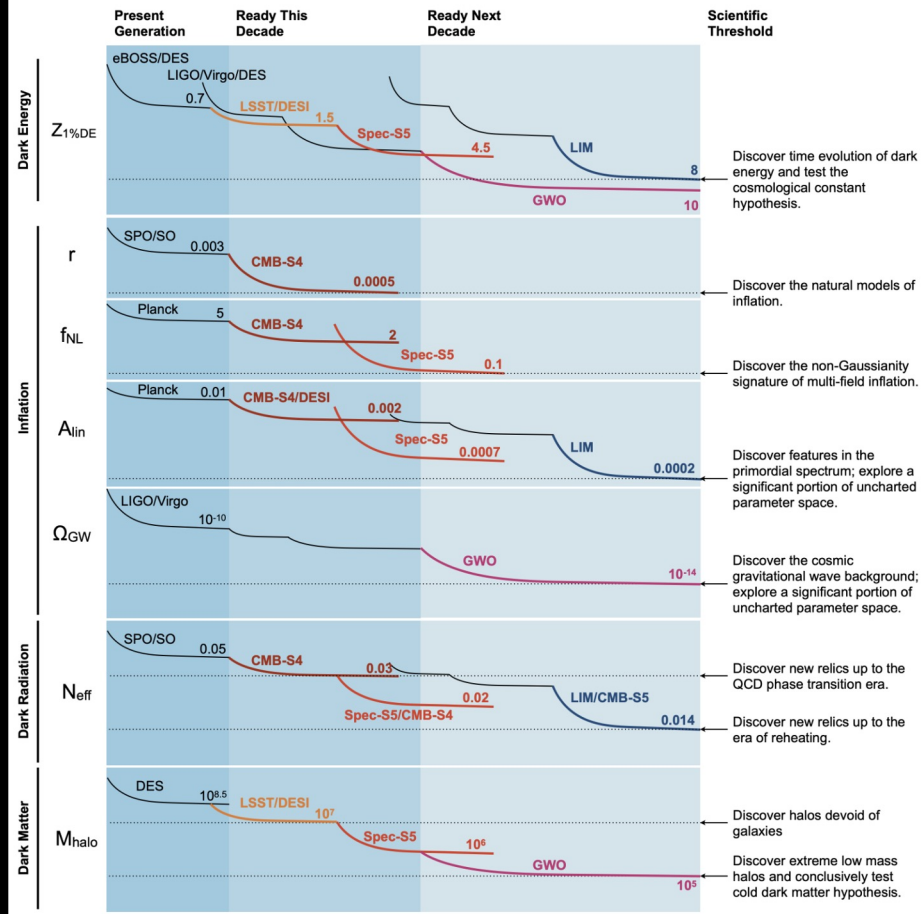

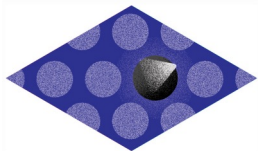

Search for Direct Evidence of New Particles

We need to actually see what the universe has given us. The most robust technique is to **directly produce new kinds of particles**, either with increasingly energetic accelerators or increasingly intense ones.

- A question of importance given LHC results: ***are there additional particles that stabilize the mass scale of the Higgs and weak bosons?*** They would otherwise require extreme fine tuning of parameters before renormalization. Naturalness may be the most important question that the next energy-frontier collider will address.
- In general, what else is out there? ***Most of the universe isn't Standard Model particles***, and the SM can't answer questions like the matter-antimatter asymmetry. **There *must* be new physics.**

Most current activity is at the Large Hadron Collider and its upcoming upgrade, the High Luminosity LHC.

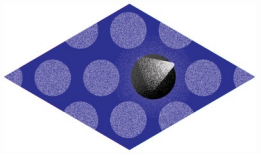

Opportunities this decade and beyond

- Top priority: Complete the ongoing **ATLAS, CMS**, and **LHCb** experiments.
- Next: the **HL-LHC** and a **Higgs Factory** will expand our reach in directly producing new particles.
- Recommended small projects could open up exciting possibilities with the **Forward Physics Facility** at CERN or using protons from **PIP-II** at FNAL.
- A **10 TeV pCM collider** would provide dramatic increases in sensitivity to new particles and bring energy frontier **back to US soil**.

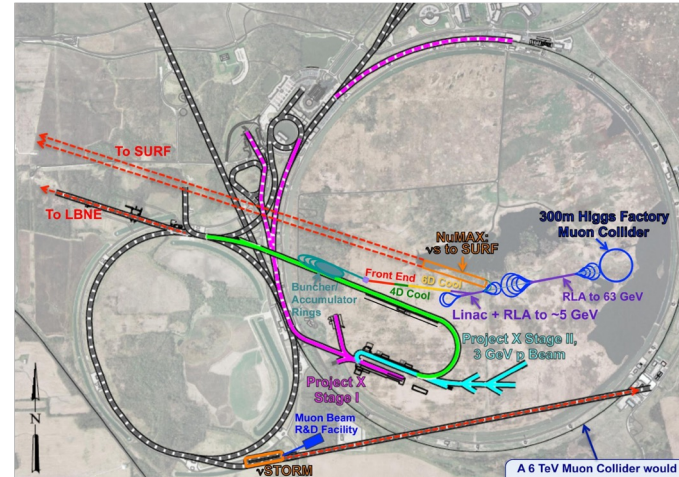

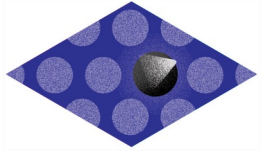

Recommended: Agile Projects Seeking Long Lived Particles

Growing interest in looking for *long-lived particles (LLP)* – weakly coupled, so produced rarely, travel through shielding, decay away from production point

Various proposals for auxiliary detectors at the LHC to detect such objects

P5 recommends such experiments proceed as “agile experiment proposals”

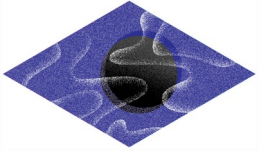

Pursue Quantum Imprints of New Phenomena

- ***Historically, we have sometimes found evidence for unknown particles and interactions by comparing careful measurement with theoretical predictions***
 - beta decay -> weak force
 - certain kaon decays suppressed -> charm quarks
 - CP violation in kaons -> bottom and top quarks
 - precision top quark and W boson mass measurements -> the Higgs boson mass is restricted
- ***This process can be extended with intense beams and large samples of particles***, even without enabling the highest possible energies
 - *There are currently existing tensions* that might be signs of something new: the anomalous magnetic moment of the muon ($g-2$), and the rates of certain bottom quark decays
 - *The physics of flavor is particularly sensitive to quantum imprints* of particles that are not present in either the initial or final state of interactions. Progress requires clean theoretical predictions and high precision experiments with excellent control of systematic uncertainties.

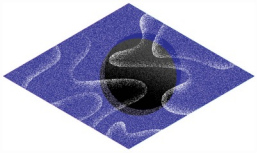

Top Priority: Complete Ongoing Mu2e, Belle II, LHCb, ATLAS, and CMS Projects

Mu2e will search for Charged Lepton Flavor Violation, improving our sensitivity by four orders of magnitude.

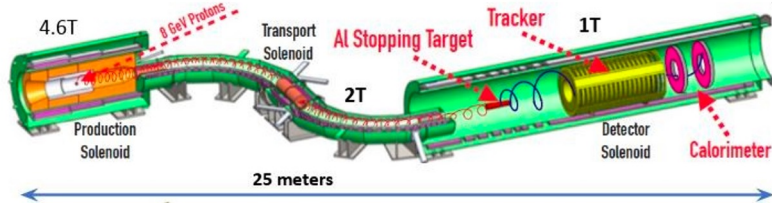

Belle-II and LHCb focus on decays of bottom and charm quarks, and of tau leptons. ATLAS and CMS have robust B-physics programs.

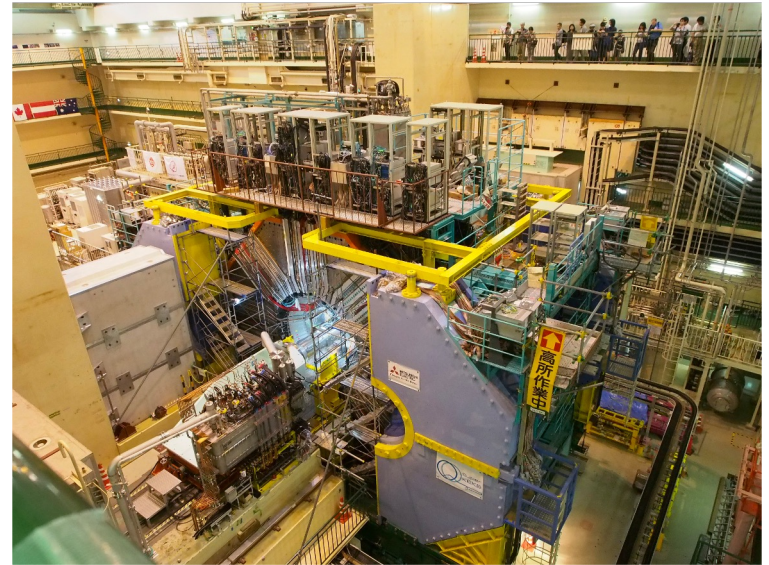

P5 also recommends upgrade for Belle II and LHCb, as well as R&D for Mu2e-II and the Advanced Muon Facility.

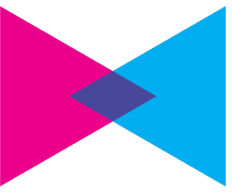

Area Recommendations

Area recommendation: increase support for theory

- Universities are home to the vast majority of theoretical research and nearly all theory student training. The level of support for theoretical research has eroded over the last decade.
- P5 recommends: Increase DOE HEP-funded university-based theory research, to propel innovation and ensure international competitiveness.

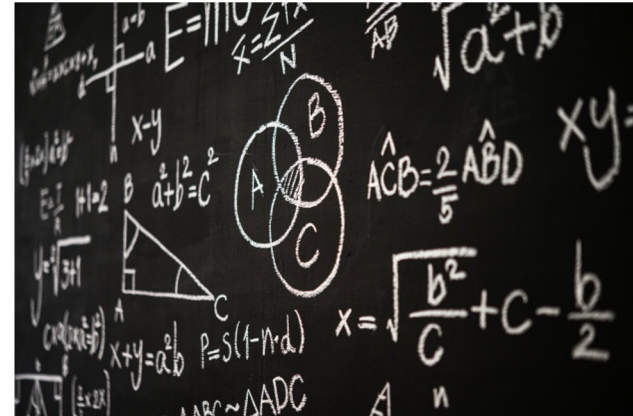

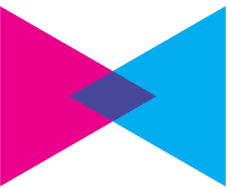

Area recommendation: for a small-project portfolio

- P5 recommends: Create an **improved balance** between small-, medium-, and large-scale projects to open **new scientific opportunities** and maximize their results, enhance **workforce development, promote creativity**, and compete on the world stage.
- Implement a new small-project portfolio at DOE, **Advancing Science and Technology through Agile Experiments (ASTAE)**, across science themes in particle physics with a **competitive program** and **recurring funding opportunity** announcements.
- The Dark Matter New Initiatives (DMNI) Program should be the first in line for construction.

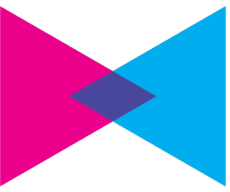

Area recommendations for instrumentation, accelerator development, facilities, and infrastructure:

- Increase the budget for generic detector R&D
- Increase annual funding to the General Accelerator R&D program
- Invest in collider detector R&D and collider accelerator R&D
- Streamline access policies for national laboratories and facilities
- Facilitate procurement processes and technical support at national laboratories
- Prioritize and maintain a supportive and welcoming culture at national laboratories
- Form a Fermilab-led task force to define a roadmap for a 20-year strategic plan for that accelerator complex
- Assess the FNAL Booster synchrotron to mitigate risks associated with DUNE operation
- Maintain the capabilities of NSF infrastructure at the South Pole

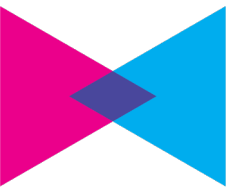

Area recommendations for software, computing, cyberinfrastructure, and sustainability:

- Leverage and use resources for national initiatives in AI/ML, quantum information science, and microelectronics.
- Adapt software and computing systems to emerging hardware and other advances in computing technologies.
- Ensure sustained support for key cyberinfrastructure such as simulation tools, information resources, and widely used software packages.
- Embrace the roles of research software engineers and other professionals at universities and labs in realizing the vision of the field.
- HEPAP should conduct a dedicated study aimed at developing a sustainability strategy for particle physics.

Beyond Projects: The people doing the science

The long-term, highly technological nature of particle physics requires **ongoing investment in and support of the workforce, at all career stages**. The field can only thrive with **high ethical standards and broad community engagement**.

- **P5 recommends increased support for career paths beyond “faculty” and “permanent lab scientist” – in particular research scientist, hardware and software engineer, and technician positions at universities.**
- Funding should be available for developing partnerships to **improve and broaden recruiting, to improve training and mentoring, and to retain personnel** with living wages and sufficient support for caregiver and family responsibilities.
- **Comprehensive work climate studies** should be performed in conjunction with experts in such studies.
- The funding agencies and laboratories should provide **infrastructure to report and resolve violations of ethical conduct**, at scales from individual investigators to large formal collaborations.
- **Dissemination of results** to the public should be a standard part of operations and research budgets.

Figure 1 – Program and Timeline in Baseline Scenario (B)

Index: ■ Operation ■ Construction ■ R&D, Research P: Primary S: Secondary
§ Possible acceleration/expansion for more favorable budget situations

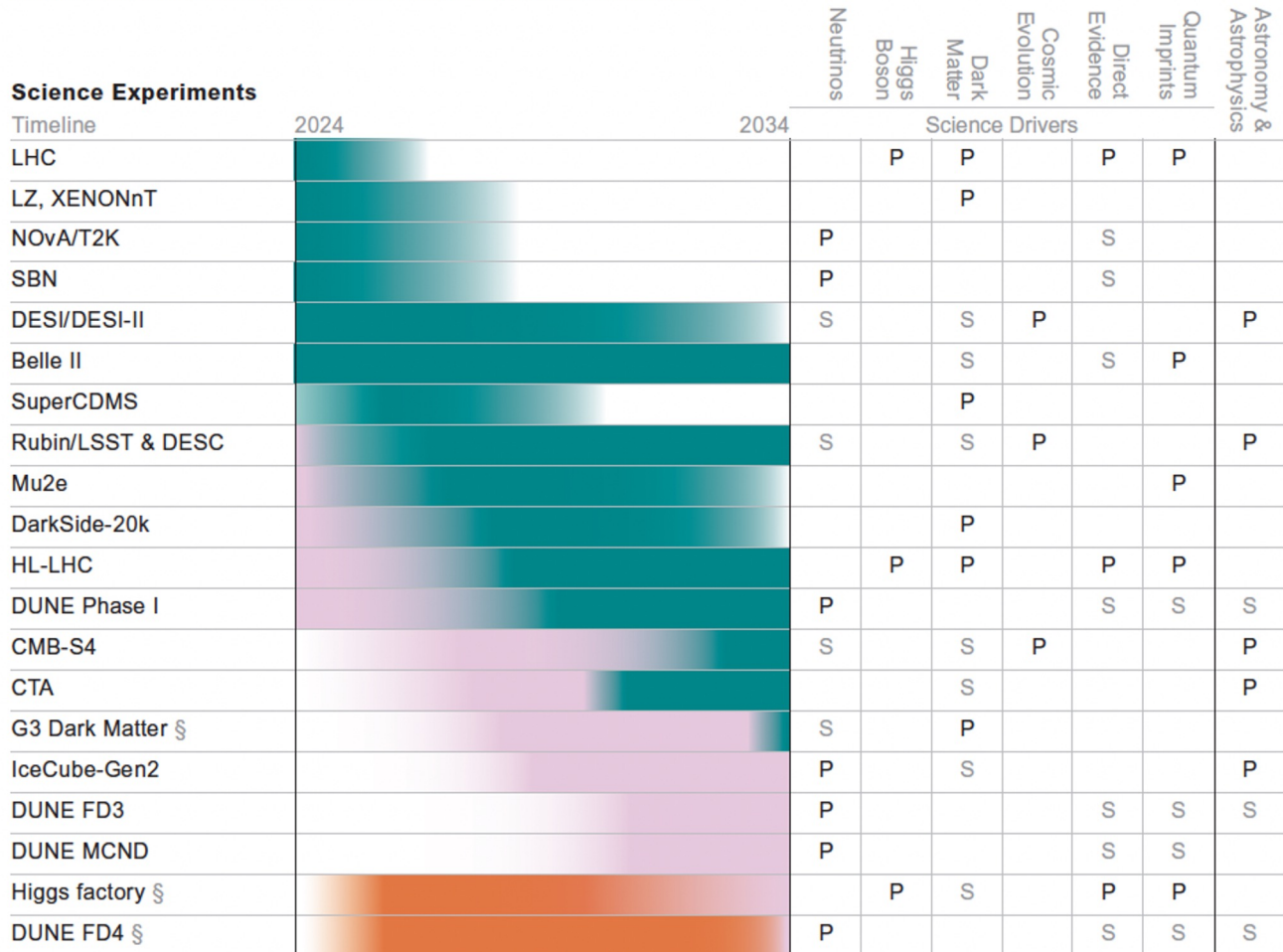

The Primary/Secondary designation reflects the panel's understanding of the project's focus, not the relative strength of the science case.

Figure 1 – Program and Timeline in Baseline Scenario (B)

Index: ■ Operation ■ Construction ■ R&D, Research P: Primary S: Secondary
 § Possible acceleration/expansion for more favorable budget situations

Line intensity mapping	Higgs factory §								
	DUNE FD4 §						P	S	S
	Spec-S5 §						S	P	P
	Mu2e-II								P
	Multi-TeV §							P	S
	LIM							S	P

Advancing Science and Technology through Agile Experiments

ASTAE §									
---------	--	--	--	--	--	--	--	--	--

Science Enablers

Proton improvement plan

 BR: Booster replacement
 AMF: Advanced muon facility

LBNF/PIP-II								
ACE-MIRT								
SURF Expansion								
ACE-BR §, AMF								

Approximate timeline of the recommended program within the baseline scenario. Projects in each category are in chronological order. For IceCube-Gen2 and CTA, we do not have information on budgetary constraints and hence timelines are only technically limited. The primary/secondary driver designation reflects the panel's understanding of a project's focus, not the relative strength of the science cases. Projects that share a driver, whether primary or secondary, generally address that driver in different and complementary ways.

Increase in Research and Development

General accelerator R&D

GARD §								
Theory								
Instrumentation								
Computing								

Rebalancing the HEP portfolio

- Energy Frontier
- Fermilab accelerator
- Possible New Projects
- Test Facilities & Demonstrator
- Cosmic Frontier
- Intensity Frontier
- Small Projects Portfolio

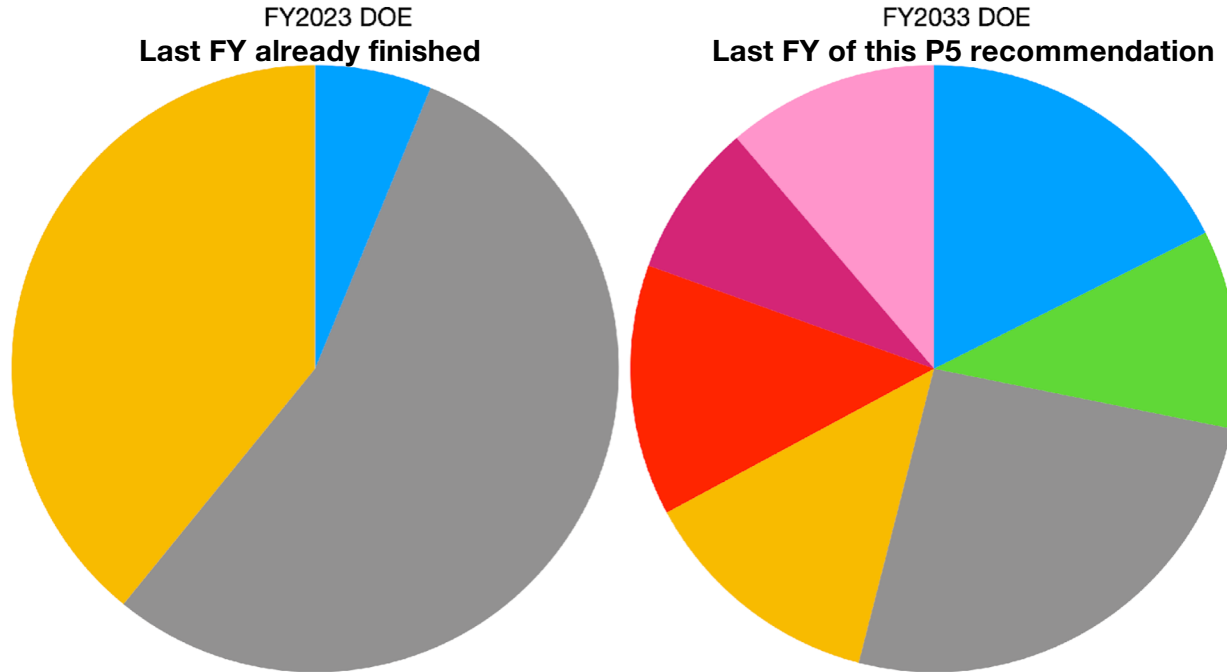
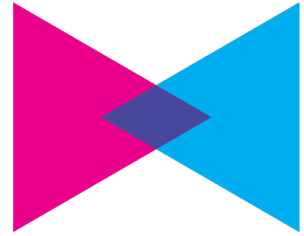

Fig. 3 Composition of DOE Projects in FY2023 (enacted) and FY2033 (recommended) in in our budget exercise. Demonstrator and Small Projects Portfolio are regarded as Projects for this pie chart.

Summary



- The Particle Physics Prioritization Panel has reviewed proposals for projects in particle physics in the next decade and beyond.
- A diverse range of projects is recommended, from a physics and project size perspective and considering the global context.
- Discoveries will be enabled by the recommended projects.
- The panel made recommendations for improving the health of the field beyond projects.

Very exciting times in particle physics!