

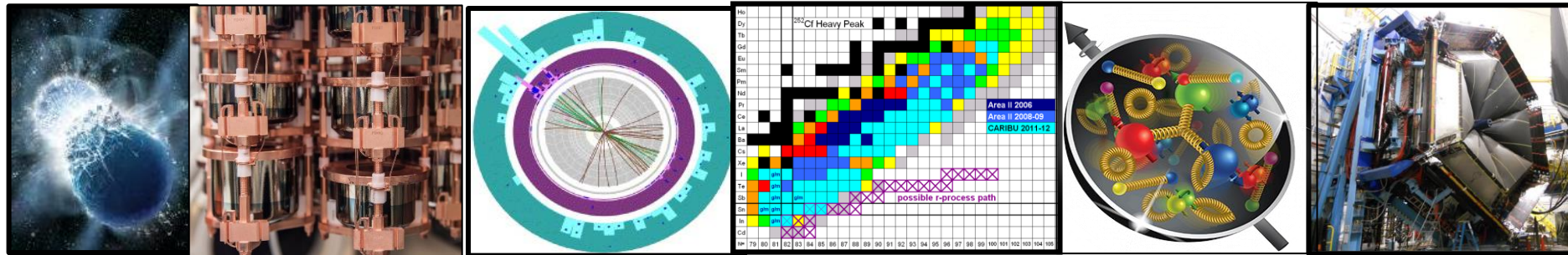

# DOE Nuclear Physics Research, Facilities, Priorities, and Opportunities

NSAC Meeting  
July 13, 2022

Dr. Timothy J. Hallman  
Associate Director of the Office of Science  
for Nuclear Physics



# DOE NP is a Primary Federal Steward of U.S. Nuclear Physics Research

DOE NP supports ~ 90% of the nation's investment in basic research in nuclear physics in the U.S.

**It has a leading role in Strategic Planning, Funding, and Implementation**

## Goals and Deliverables:

- Knowledge
- Leadership class facilities
- New technology
- A highly-trained, diverse workforce capable of supporting DOE & other missions

Where NP PHDs go

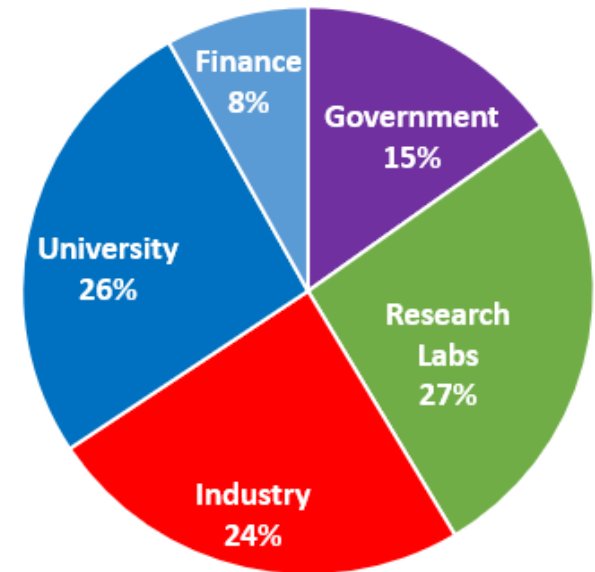

U.S. science, commerce, medicine, defense —all benefit, in part, from a stable level of sustained competence, capability, capacity, and leadership in nuclear physics; DOE NP is a primary steward responsible for reliably delivering that benefit.

# The Reach of DOE NP Science Research

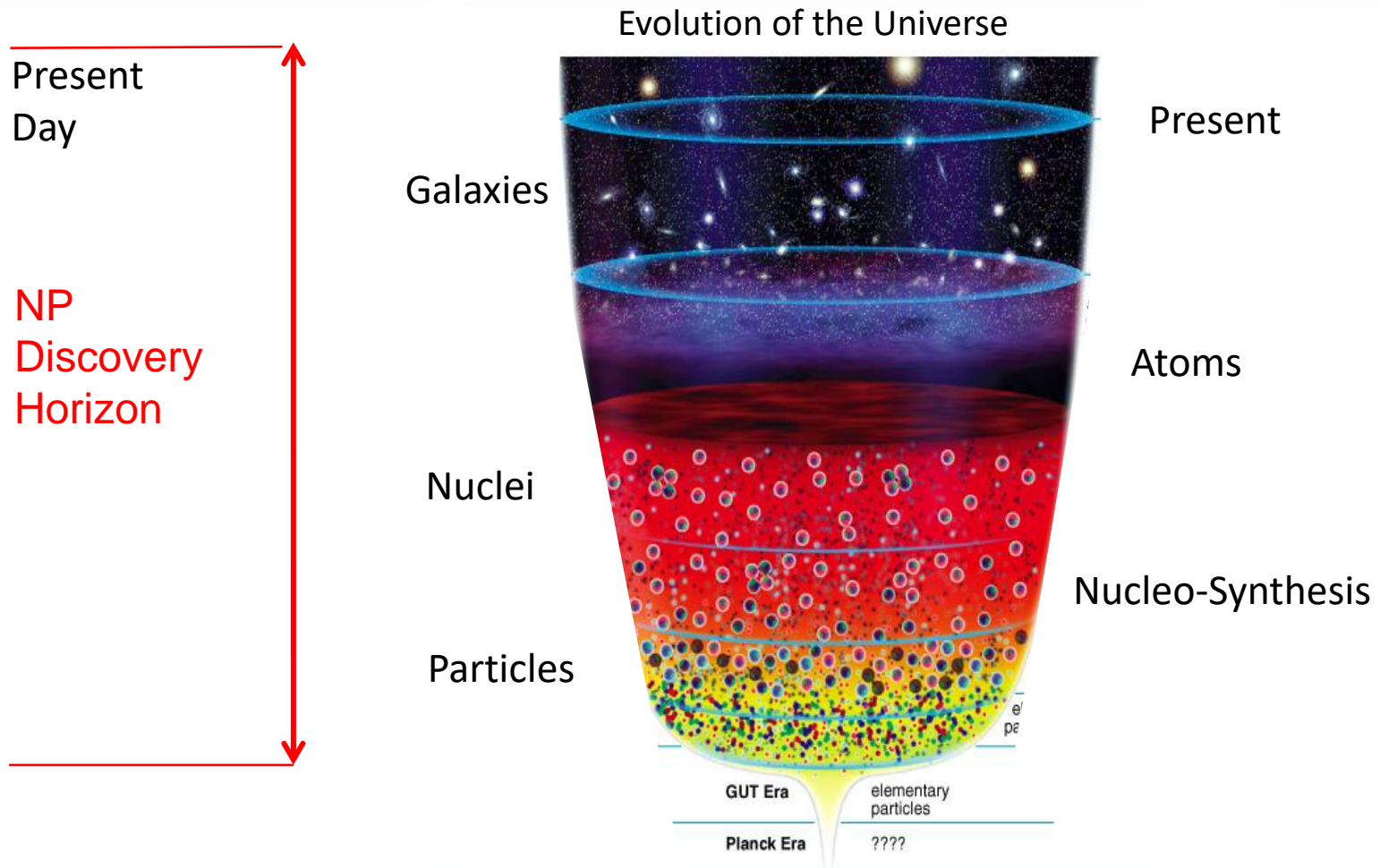

The vast range of time ( $\mu\text{sec}$  to 13.8B years) and physical scales (quarks to galaxies) requires “microscopes” and tools of varying resolving “power”



# A Major Part of NP Stewardship is Operating:



*Relativistic Heavy Ion Collider*



*Continuous Electron Beam Accelerator Facility*

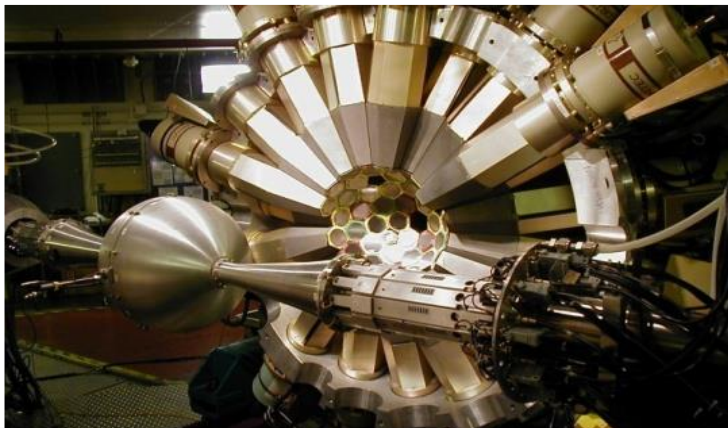

*Argonne Tandem Linac System*

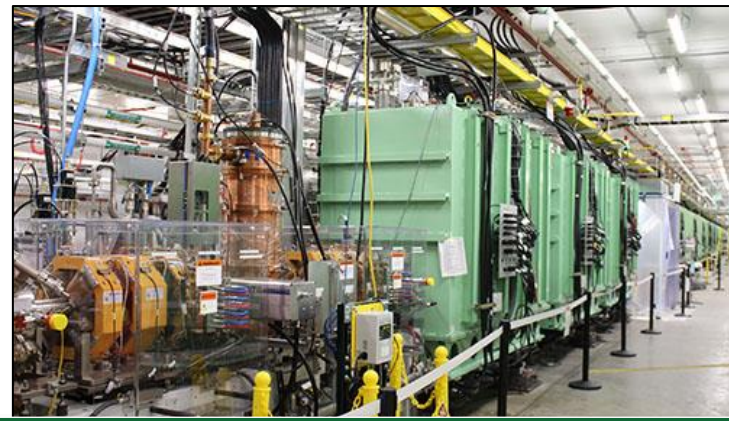

*Facility for Rare Isotope Beams*

“Microscopes” of Varying Resolving Power



# First Science at the DOE Facility for Rare Isotope Beams (FRIB)

Start of FRIB Construction in 2013



Start of FRIB Science, May 2022

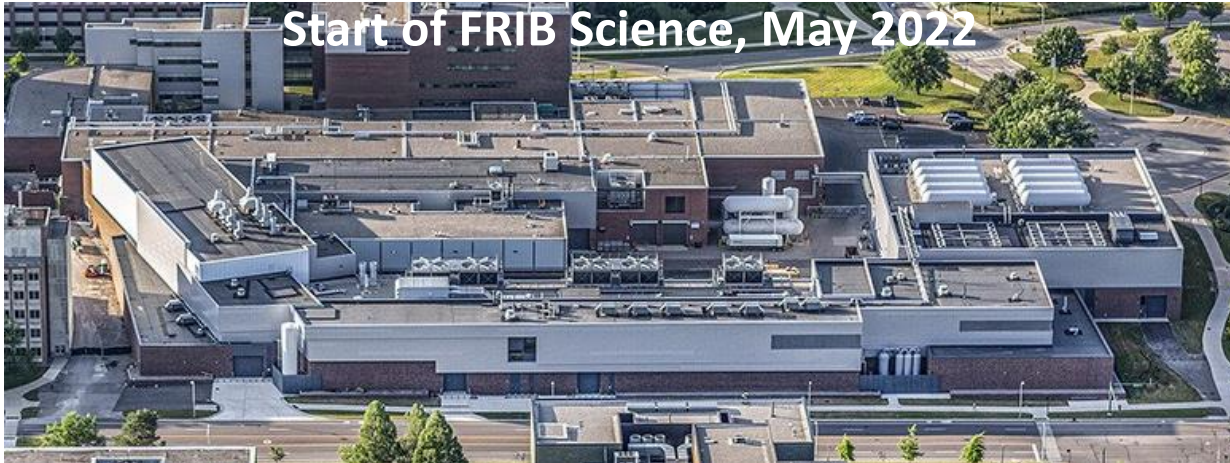

# A Brief Overview of the Facility for Rare Isotope Beams



- FRIB construction started in 2013 and finished in 2022, on cost and ahead of schedule
- FRIB was constructed by DOE (\$635M) and Michigan State University (\$94.5M) under a unique Cooperative Agreement
- Now complete, FRIB provides access to 80% of all isotopes predicted to exist in nature

	PYs	FY 2017	FY 2018	FY 2019	FY 2020	FY 2021	DOE Total	MSU	TOTAL
<b>FUNDING PROFILE</b>	318,000	100,000	97,200	75,000	40,000	5,300	635,500	94,500	730,000

- Secretary Granholm and MSU President Stanley “Cut the Ribbon” declaring FRIB open for scientific research on May 2, 2022
- On May 19, 2022, first scientific results on isotopes never-before produced in sufficient quantity for scientific study are awaiting publication



# FY 2022 Highlight



Secretary Granholm at the  
FRIB Ribbon Cutting

May 2, 2022



## FRIB Experiment E21062

**Spokespersons:** *J. Allmond (ORNL), H. Crawford (LBNL), B. Crider (Mississippi State University), R. Grzywacz (University of Tennessee Knoxville) and V. Tripathi (Florida State University)*

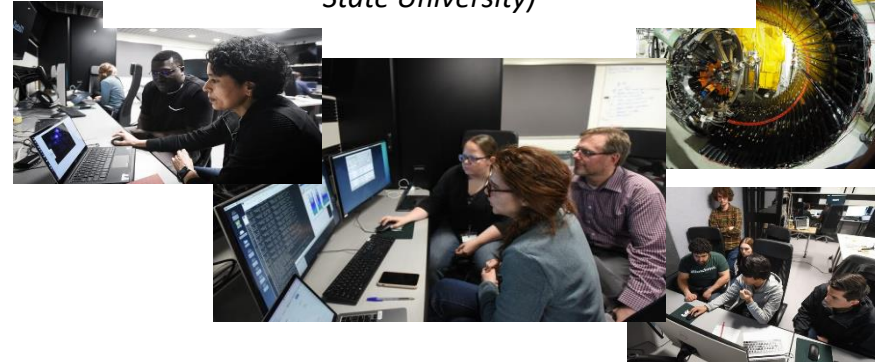

May 19, 2022

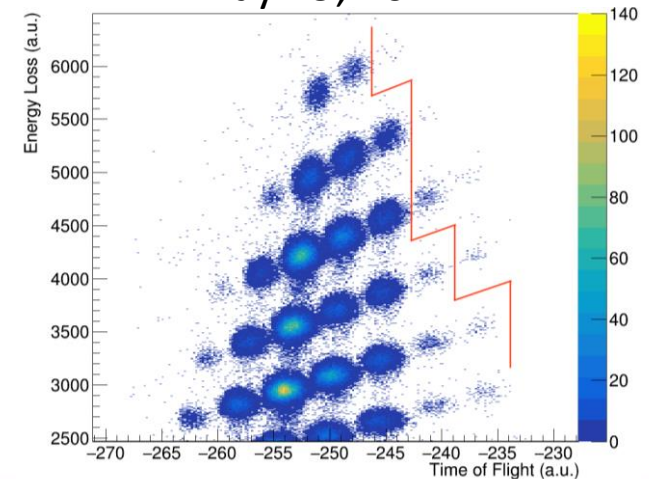

U.S. DEPARTMENT OF  
**ENERGY**

Office of  
Science

NSAC Meeting

July 13, 2022 7

# Punchline

---

Two weeks after its ribbon cutting, FRIB is producing--and in the process of publishing--“never-before-seen” groundbreaking scientific results. FRIB is off and running toward a science horizon promising exciting new game changing insights into the nature of the universe we live in.

The success of FRIB construction and early science is a wonderful testament to the successful cooperation and sustained dedication of MSU, DOE/SC, NSF, OMB, and Capitol Hill.



# The High-Level DOE NP Work Plan

1. Operate and get science out from the Relativistic Heavy Ion Collider (RHIC), the Continuous Electron Beam Accelerator Facility (CEBAF), the Argonne Tandem Linac Accelerator System (ATLAS) and the Facility for Rare Isotope Beams (FRIB)
2. Make progress on a U.S.-led ton-scale neutrino-less double beta decay experiment.
3. Start construction of a high-energy high-luminosity polarized electron-ion collider (EIC)
4. Implement smaller scale instrumentation to take advantage of facility capabilities

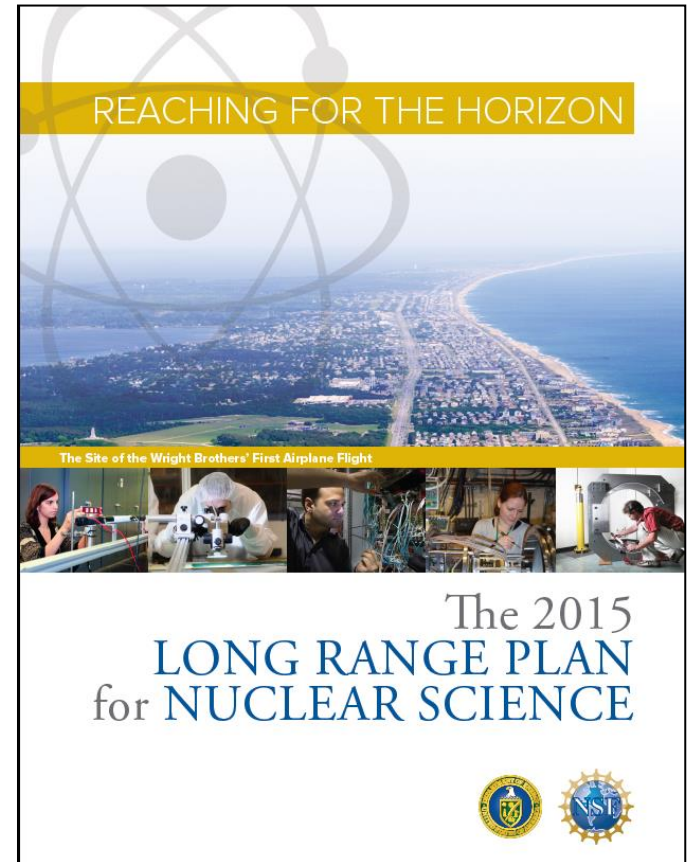

The work plan centers on scientific discovery: to understand all forms of nuclear matter. The knowledge gained benefits energy, commerce, medicine, and national security.

Beginning preparations are getting underway for the next Long Range Plan Exercise

# Recent Impactful Accomplishments

- ❑ Discovery that ionizing radiation reduces coherence time for entangled quantum states
  - Need new quantum materials or/and underground Quantum Computing
- ❑ First known observation of the Breit-Wheeler two-photon process at RHIC
  - Confirmation of Quantum Electro-Dynamic (QED) process; possibility of  $e^+e^-$  pair production via lasers
- ❑ Discovery that heavy nuclei have a neutron skin (CEBAF)
  - New constraints on neutron star radii and their equation of state
- ❑ Implementation of dynamical fermions and the real pion mass in Lattice QCD
  - Major advance in fidelity of Lattice Quantum Chromodynamics calculations
- ❑ Initiation of the FRIB science program
  - Opening a new frontier to understand heavy element production in cosmos
- ❑ Integration of AI technology at CEBAF to make it more fault tolerant
  - Test-bed for use of Artificial Intelligence in accelerator control and optimization

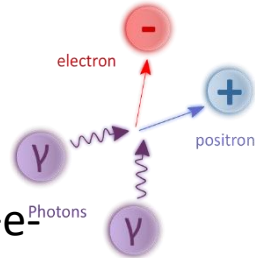

# The Trend of Appropriations Supporting the NP Work Plan

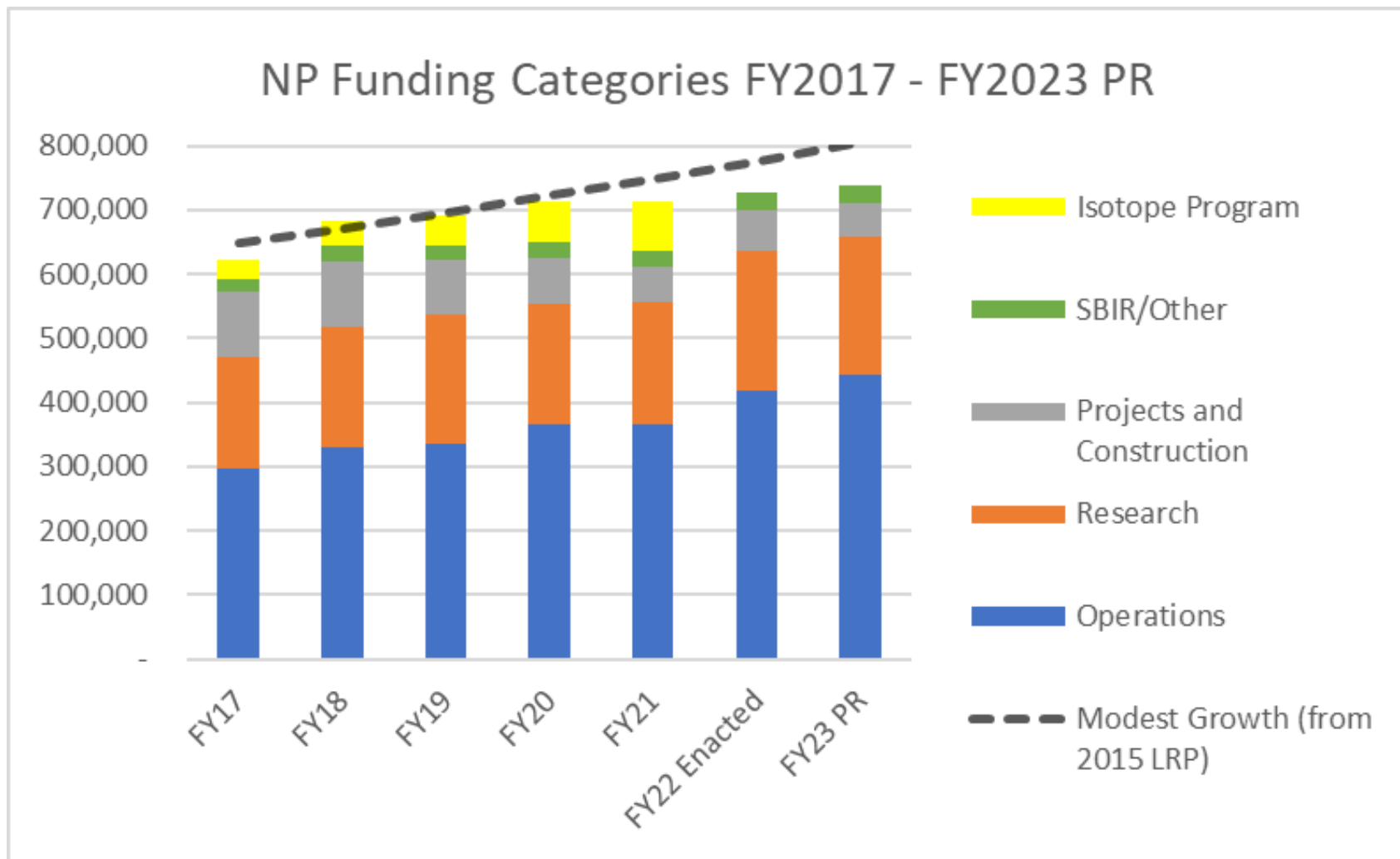

Recent Ops increases largely due to bringing FRIB online and making reliability upgrades at CEBAF



# NP Projects: Status and Operations Plan

Project	Location	Status	Cost	CPI	SPI	CD-4	Operation cost plan
<b>Construction Projects</b>							
Facility for Rare Isotope Beams (FRIB)	MSU	CD-4	\$730M	1.00	1.00	6/2022	Included in NP budget formulation
Electron-Ion Collider (EIC)	BNL	CD-1	\$1.7B to \$2.8B			Q4 FY33	RHIC operations funds redirected to EIC project recovered for EIC operations
<b>Major Items of Equipment</b>							
Gamma Ray Energy Tracking Array (GRETA)	LBNL	CD-2/3	\$58.3M	0.98	0.94	4/2028	Mostly covered by host laboratory operations experimental support
Super Pioneering High Energy Nuclear Interaction Experiment (SPHENIX)*	BNL	PD-3	\$27.0M	1.02	0.85	12/2022	Covered by RHIC operations experimental support
Measurement of Lepton-Lepton Electroweak Reactions (MOLLER)	TJNAF	CD-1	\$45.8M to \$56.6M			Q4 FY27	Covered by TJNAF operations experimental support
High Rigidity Spectrometer (HRS)	MSU	CD-1	\$85.0M to \$111.4M			Q2 FY29	Covered by FRIB operations experimental support
Ton Scale Neutrinoless Double Beta Decay (TS-NLDBD)	TBD	CD-0	\$215M to \$250M			TBD	TBD

Blue indicates "Completed"

# In the Future Plan, RHIC Completes its Mission and the EIC is Built

CD-1 was attained in June 2021.

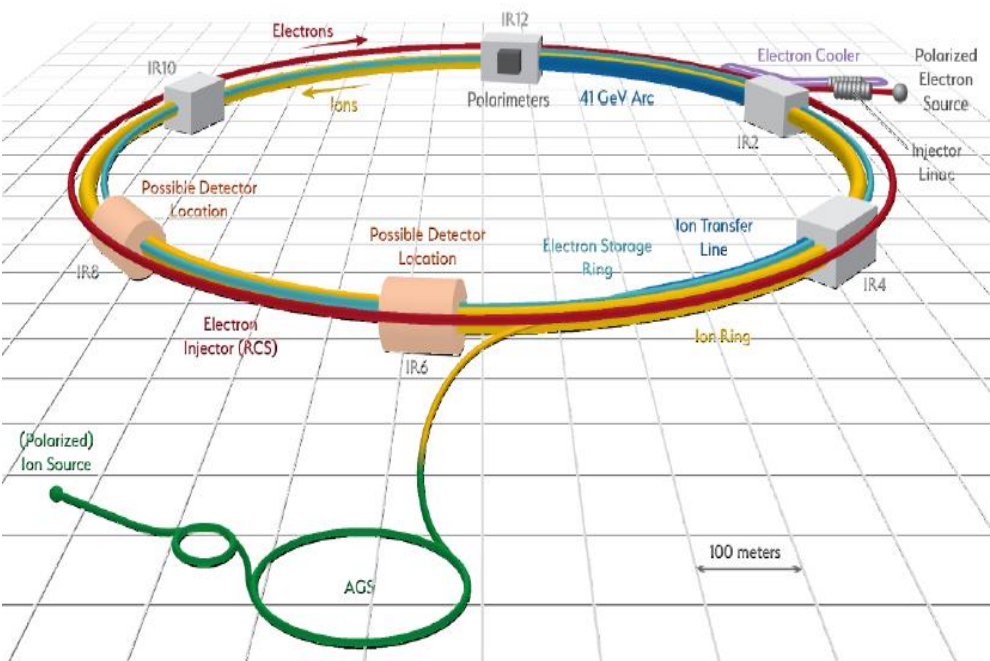

- Located at BNL and with TJNAF as a major partner. Estimated cost between \$1.7 and \$2.8 billion.
- Utilizes existing RHIC assets; adds electron storage ring, & electron cooling



NAS: A US- based EIC will uniquely answer

- How does the mass of the nucleon arise?
- How does the spin of the nucleon arise?
- What are the emergent properties of dense systems of gluons?"

The EIC will also maintain U.S. leadership in the accelerator science and technology of colliders

The international community is already highly engaged with 1110 collaborators, from 32 countries, and 235 institutions actively working on EIC development

# The Global Campaign to Determine the Fundamental Nature of the Neutrino

The Search for Neutrino-less Double Beta Decay ( $0\nu\beta\beta$ ): in a selected nucleus, two neutrons decay into two protons and two electrons, with no neutrinos being emitted.

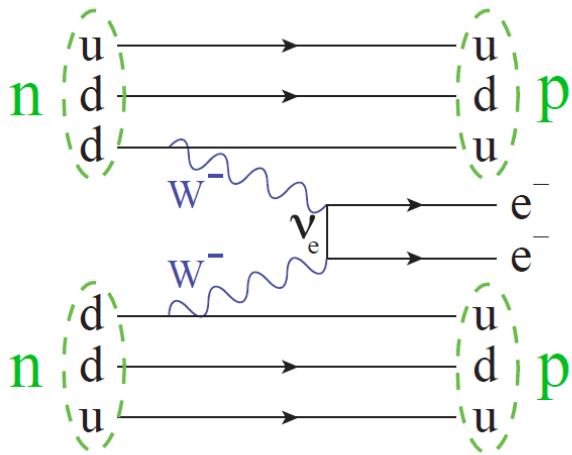

It required the two neutrinos from the two  $W^-$  particles to annihilate, proving the neutrino is its own anti-particle

## Three Proposed Technologies

- Scintillating bolometry (**CUPID**,  $^{100}\text{Mo}$  enriched  $\text{Li}_2\text{Mo}_4$  crystals)
- Enriched  $^{76}\text{Ge}$  crystals (**LEGEND-1000**, drifted charge, point contact detectors)
- Liquid Xenon TPC (**nEXO**, light via SiPM, drifted ionization)

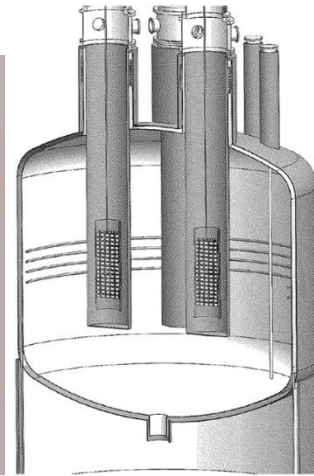
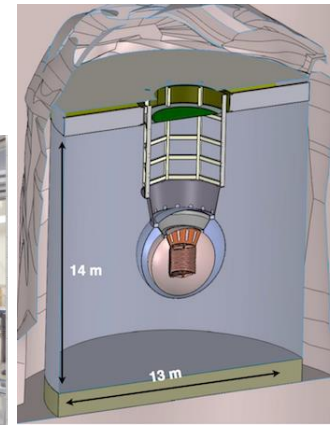
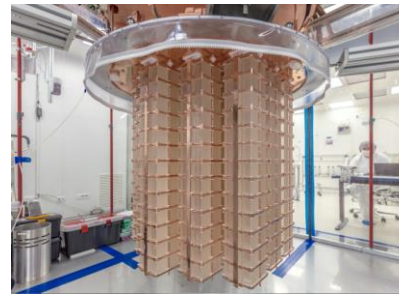

Potential Partners: Italy, Canada, and Germany

# The NP Line of Sight to Broader Impacts & Other Missions

## NP is providing new and updated nuclear data to existing “customers”

- Working to identify impactful nuclear data needs and leverage resources
  - Ex: Advanced Reactors with DOE/NE, ARPA-E

## NP is reaching out to new nuclear data application customers

- Electronics protection (NASA, Missile Defense Agency, Federal Aviation Administration)
- Human safety (NASA [spaceflight], NIH [ion beam therapy])
- Advanced reactors (ARPA-E, NASA)

## NP is exploring a mechanism for Rapid Response Nuclear Data

- Many federal agencies have projects with nuclear data shortfalls
- Project funding / scope does not cover nuclear data activities
- USNDP is investigating a process where performers can submit requests for urgent, high impact nuclear data needs

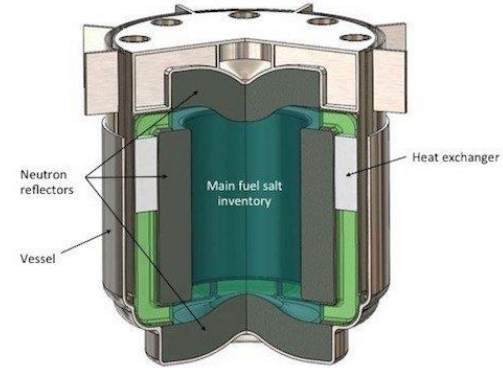

NP Leads a Nuclear Data Interagency Working Group (NDIAWG) that published 4 FOAs

# NP Traineeships: 36 Proposals Resulting in 110 Traineeships

NP traineeship award recipients include:

- 18 MSIs,
- 10 other colleges/universities,
- 5 DOE laboratories

40% of trainees identify as Hispanic  
40% of trainees identify as Black or African American  
10% of trainees identify as White  
10% of trainees identify as other

MSI award recipient distinctions:

- 9 Hispanic Serving Institutions (HSIs),
- 8 HBCUs,
- 5 Asian American, Native American, and Pacific Islander Serving Institutions (AANAPISI),
- 1 Predominantly Black Institution (PBI)

All other institutions on the map are involved in the traineeship program as recruitment sites (38), Co-Is (9), members of INSIGHT (8), and/or hosts (7)

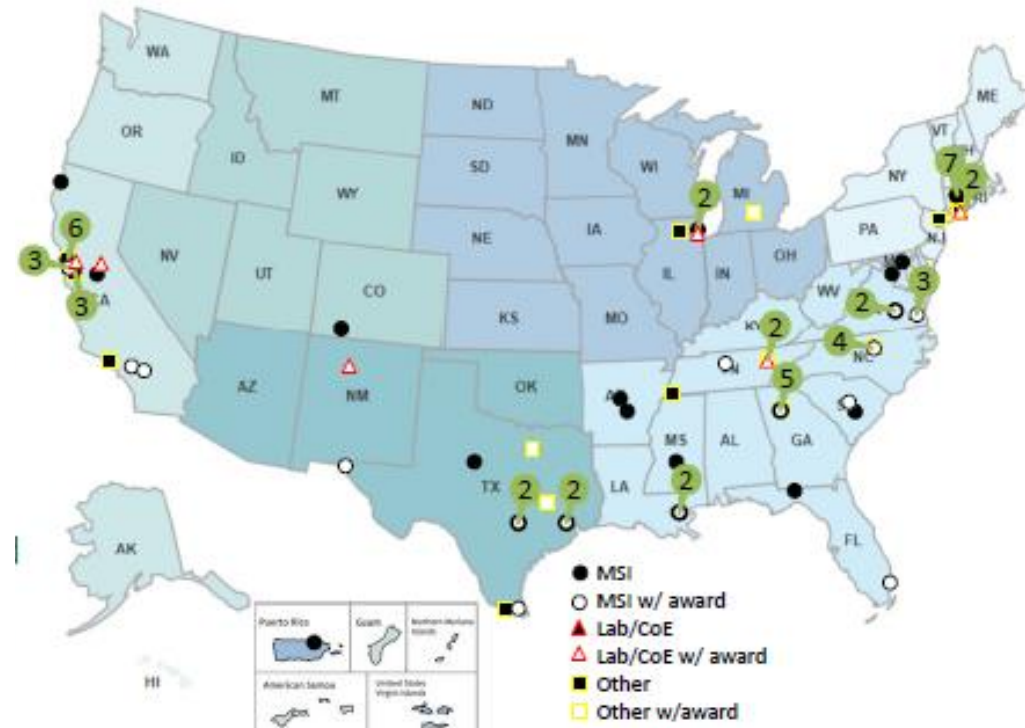



# Additional NP Traineeship and DEI Information

- The INSIGHT team (left to right): Paul Gueye (MSU), Felecia Commodore (ODU), Geraldine Cochran (Rutgers), responsible to:



- Assess effectiveness
- Facilitate communication and coordination
- Survey to ascertain criteria related to retention
- Gather data for input to SC

- Very strong statements by NP AD in community forums (APD/DNP Meetings) that the SC Statement of Commitment will be respected in the NP Community and that unwanted or abusive behavior, WILL STOP NOW.
- Planned focus of FY 2023 RENEW investment: vehicle(s) for anchoring sustained investment at HBCUs and MSIs in technical areas important for SC (e.g. imaging, cryogenics) to “uptake” and retain talented trainees

# NP FY2022 Enacted and FY2023 PR

	FY22 Enacted	FY23 PR
<b>Medium Energy</b>	<b>\$ 196.1 M</b>	<b>\$ 193.7 M</b>
CEBAF Ops	\$ 142.7 M	\$ 143.4 M
Research	\$ 53.4 M	\$ 50.3 M
<b>Heavy Ion</b>	<b>\$ 255.5 M</b>	<b>\$ 245.0 M</b>
RHIC Ops	\$ 183.9 M	\$ 191.8 M
Research	\$ 46.5 M	\$ 43.2 M
Project	\$ 25.0 M	\$ 10.0 M
<b>Low Energy</b>	<b>\$ 199.1 M</b>	<b>\$ 217.5 M</b>
FRIB, ATLAS Ops	\$ 107.8 M	\$ 125.5 M
Research	\$ 73.9 M	\$ 68.1 M
Projects	\$ 17.4 M	\$ 23.9 M
<b>Theory</b>	<b>\$ 57.3 M</b>	<b>\$ 63.0 M</b>
Research	\$ 57.3 M	\$ 63.0 M
<b>Facility Construction</b>	<b>\$ 20.0 M</b>	<b>\$ 20.0 M</b>
EIC	\$ 20.0 M	\$ 20.0 M
<b>Total, NP</b>	<b>\$ 728.0 M</b>	<b>\$ 739.2 M</b>

Targeted increases are made in the FY 2023 Request compared to FY 2022 Enacted **\$739.2M vs \$728M (+11.2M)**

- FRIB Ops Δ
- GRETA \$15.8M
- AI/ML \$6.5M
- RENEW \$4M
- FAIR Initiative \$3M
- Accelerate Innovate \$2M

\$35.3M

Funds to support targeted increases above the overall NP increase come from the NP base.

The FY 2023 House Mark for NP is \$780M

# NP Participation in SC Initiatives

SC/DOE Initiatives	FY21 Enacted	FY22 Enacted	FY23 PR
Quantum Information Sciences (QIS)	13,347	10,866	10,866
Artificial Intelligence and Machine Learning (AI)	4,000	4,000	8,000
Microelectronics	-	518	518
Strategic Accelerator Science and Technology Initiative	-	1,037	-
Reaching a New Energy Sciences Workforce (RENEW)	-	3,000	6,000
Funding for Accelerated, Inclusive Research (FAIR)	-	-	2,000
Accelerate Innovations in Emerging Technologies	-	-	4,000

Scientific Discovery Through Advanced Computing \$ 2,878 \$ 3,543 \$ 3,494

NP is also cultivating the possibility of a symbiosis with NIH to spark a significant advance in imaging useful for both DOE and NIH research

# FY 2023 Request Highlights - NP

- FRIB begins its first full year of science research studying atomic number 28 nuclei near the limit for nuclear existence
- NP User Facilities (RHIC, CEBAF, ATLAS, and FRIB) all operate at or above 90% utilization
- The Electron-Ion Collider “memorializes” international in-kind contributions as part of finalizing preparations for CD-2 Review, *Approve Performance Baseline*. EIC A/E design is begun.
- sPHENIX begins science research at RHIC to determine the novel properties of the quark-gluon plasma
- LEGEND-200 begins initial search for new physics via the slowest rare decay ever attempted
- Funding for the Gamma Ray Energy Tracking Array (GRETA) MIE is in accordance with technically driven schedule
- NP investment in the AI/ML cross-cutting research and RENEW doubles
- NP participates in the new cross-cutting initiatives in Funding for Accelerated Inclusive Research (FAIR) and Accelerate Innovations in Emerging Technologies (Accelerate)



# DOE Office of Nuclear Physics

**Timothy J. Hallman, Associate Director**

Melissa Emerson, Administrative Specialist (CONTR)

**Associate Director's Office Staff**

Brian Knesel, Financial Management Specialist  
 Dannette Keen, Financial Management Analyst  
 Linnette Quick, Program Assistant (CONTR)  
 Brenda May, Program Analyst  
 Michael Famiano, International Cooperation and Outreach

**Physics Research Division**

**VACANT**, Director

Christine Izzo, Program Support Specialist

**Medium Energy & Quantum Information Science**

Gulshan Rai, Technical Advisor  
 Spyridon Margetis (IPA)

**Heavy Ion Nuclear Physics**

Kenneth Hicks

**Nuclear Structure and Nuclear Astrophysics**

Sharon Stephenson  
 Kelsie Krafton (AAAS Fellow)

**Nuclear Theory**  
 Astrid Morreale, Acting  
**VACANT**

**Nuclear Data**  
 Keith Jankowski

**Fundamental Symmetries**  
 Paul Sorensen

**Nuclear Physics Computing**  
 Xiaofeng Guo

**Facilities & Project Management Division**

**VACANT**, Director

Jehanne Gillo (Acting)

Saryna Cameron, Program Support Specialist (CONTR)  
 Paul Mantica (IPA), Technical Advisor  
 Latifa Elouadrhiri (Detailee)

**Advanced Technology R&D**

Manouchehr Farkhondeh, Deputy

**Nuclear Physics Facilities**

James Sowinski

**Nuclear Physics Major Initiatives**

Ivan Graff

**Nuclear Physics Instrumentation**

Elizabeth Bartosz

**Industrial Concepts**

Michelle Shinn

**Research Division**

8 Feds  
 1 IPAs  
 1 AAAS fellow  
 1 Acting  
 2 vacancies

FY 22 Enacted:  
**\$231.1M**

**Facilities & Projects Division**

5 Feds  
 1 IPAs  
 2 Contractors  
 1 Acting  
 1 vacancy

FY 22 Enacted:  
**\$496.9M**



# Other news

- Ken Hicks is officially a Fed responsible for Heavy Ion Physics
- Astrid Morreale is now Acting PM for Nuclear Theory
- Paul Mantica is an IPA in charge of Facilities and Projects Division
- David Cinabro joins NP as a Fed to steward NP Facilities
- Michael Famiano joins NP as a Fed to help steward outreach and international collaboration
- Spiros Margetis is an IPA assisting Gulshan Rai with Medium Energy
- Dannette Keane is a new NP budget analyst with a primary focus on execution
- Melissa Emerson is the new administrative support person for the Associate Director
- Saryna Cameron is the new support person for the Facilities and Projects Division
- Kelsie Krafton is an AAAS Fellow stewarding DEI efforts in NP
- In general NP staff are “back in the office” with modified in-person schedules
- ATLAS completion of GRETINA campaign, and shipment of GRETINA to FRIB
- ATLAS received cyclotron for nuCARIBU
- EIC detector collaboration coalescence following project detector down-select
- HRS proposal submission as part of new CA with MSU
- SBIR FY23 topics released this week
- In-person office presence will be reduced, remote work and telework will be more common. DOE supported travel is slowly opening back up subject to “conditions on the ground”.



# Urgent Plea for Assistance

---

- NP conducts several research, project, and facility reviews throughout the year
- These reviews benefit from experts in the nuclear physics community serving as panelists
- NP is looking to identify panelists for future reviews, with a goal of continuing to diversify the constitution of the future panels
- If you would be interested, please email the following information to [Saryna.Cameron@science.doe.gov](mailto:Saryna.Cameron@science.doe.gov)
  - Name
  - Institution
  - Contact information (email and phone)
  - General area of expertise (scientific and/or technical)
  - Specific area(s) of subject matter expertise
- DOE Office of Science (SC) is fully and unconditionally committed to fostering safe, diverse, equitable, and inclusive work, research, and funding environments that value mutual respect and personal integrity, and this commitment extends to NP reviews

# A Long Tradition of Partnership and Stewardship

There has been a long tradition in Nuclear Science of effective partnership between the community and the agencies in charting compelling scientific visions for the future of nuclear science.

Key factors:

- 1) Informed scientific knowledge as the basis for recommendations and next steps
- 2) Mutual respect among scientific sub-disciplines
- 3) Commitment to the greater good of nuclear science as a discipline
- 4) Meticulously level playing field leading to respect for process and outcomes
- 5) Deep appreciation for the wisdom of Ben Franklin

Staying united we can accomplish great things together



Division will setback the entire field and is the last thing needed right now



## The Main Drivers Accounting for Requested FY 2022 Increases

---

The FY 2022 Enacted required large increases over FY2021 Enacted  
**\$728M vs \$635M (+93M )**