

# US ITER Project Progress

**Brad Nelson**

*Chief Engineer, US ITER Project Office*

*Fusion Energy Sciences Advisory Committee*

*September 23, 2014*

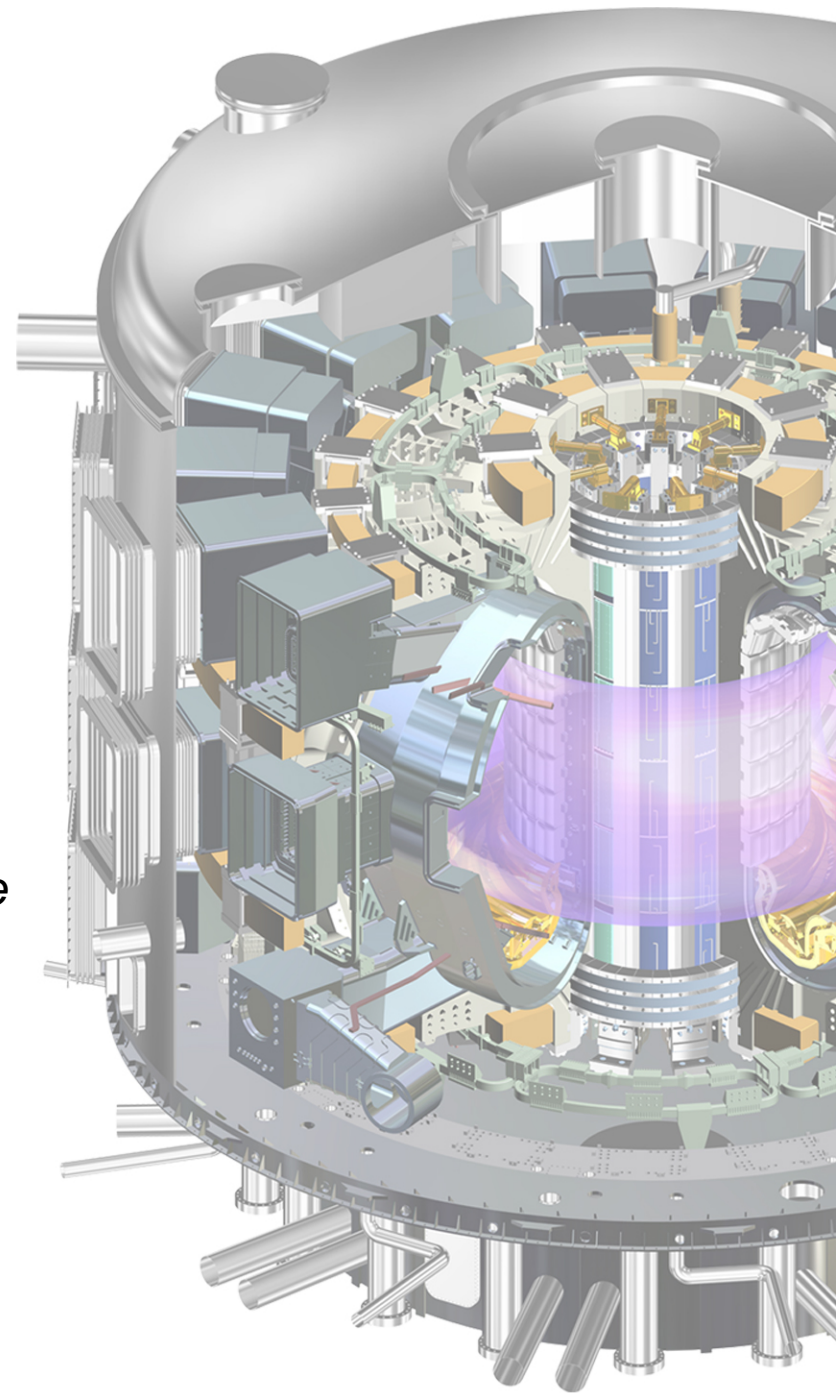



# ITER Tokamak Core in Building

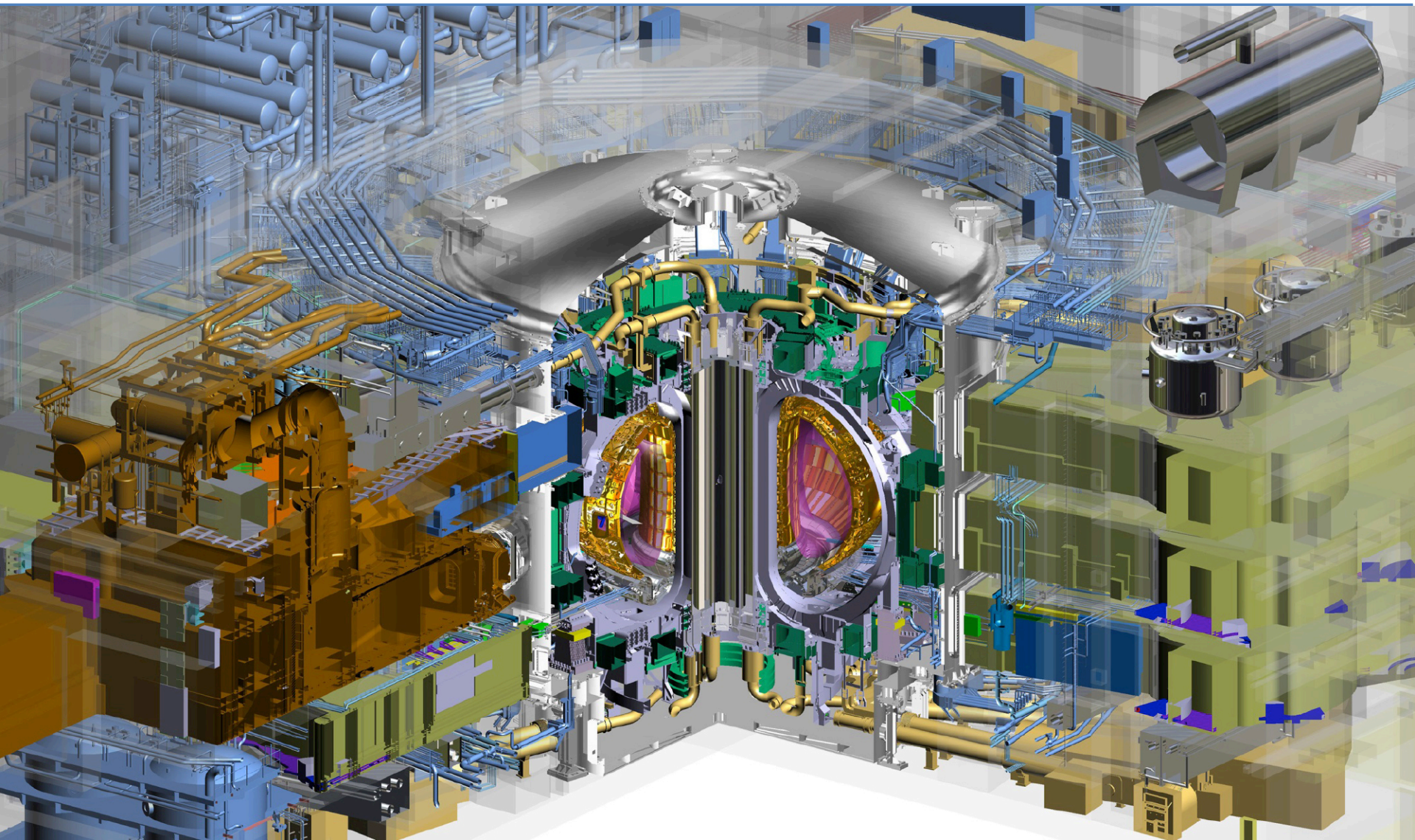





# Site Progress



# Recent Activities



Photo: ITER Organization April 2014



# Cryostat Workshop (India)



Photo: ITER Organization April 2014



# Poloidal Field Coil Winding Facility (EU)

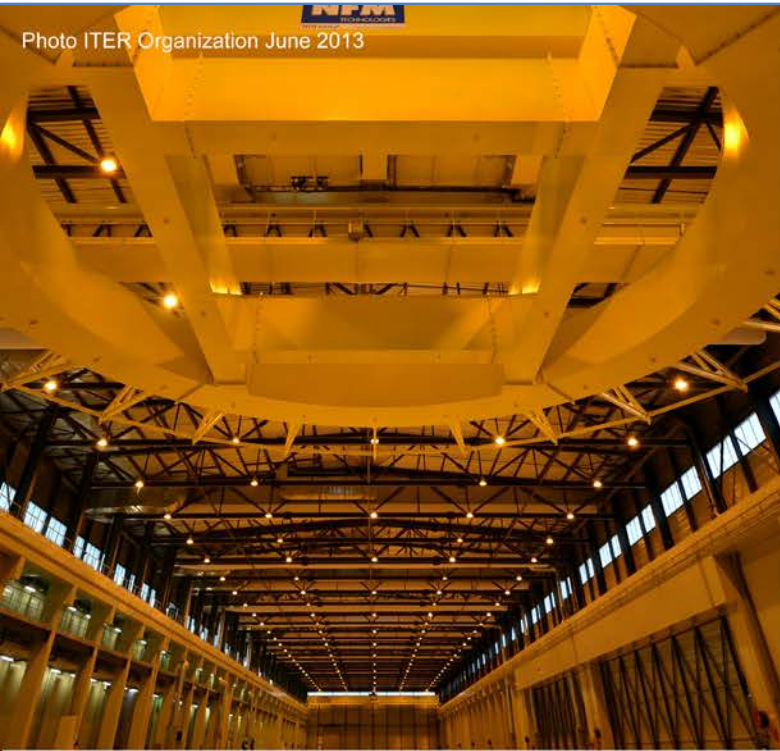

Photo ITER Organization June 2013



45mW x 252 mL





# Tokamak Pit



Photo: ITER Organization April 2014







# Tokamak Complex Floor (B2 Slab)



Photo: ITER Organization July 2014





# Tokamak Complex Floor (B2 Slab)



Photo: ITER Organization August 2014





# Tokamak Complex Floor (B2 Slab)



Photo: ITER Organization August 2014







# Fabrication of ITER Components by Global Partners is Underway





# FY 2014 Partner Achievements



**Korea**



**Russia**



**China**



**Japan**

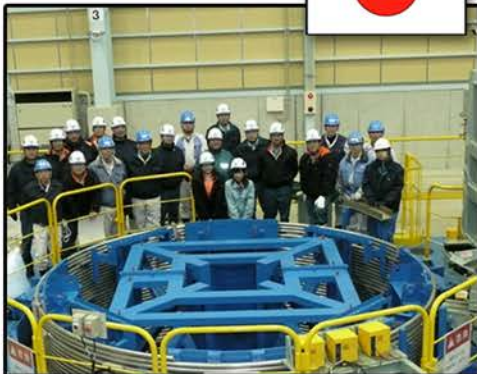
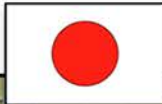

**EU**



**United States**



**Sample toroidal field conductor has been produced by the six responsible Domestic Agencies.**



# FY 2014 Partner Achievements

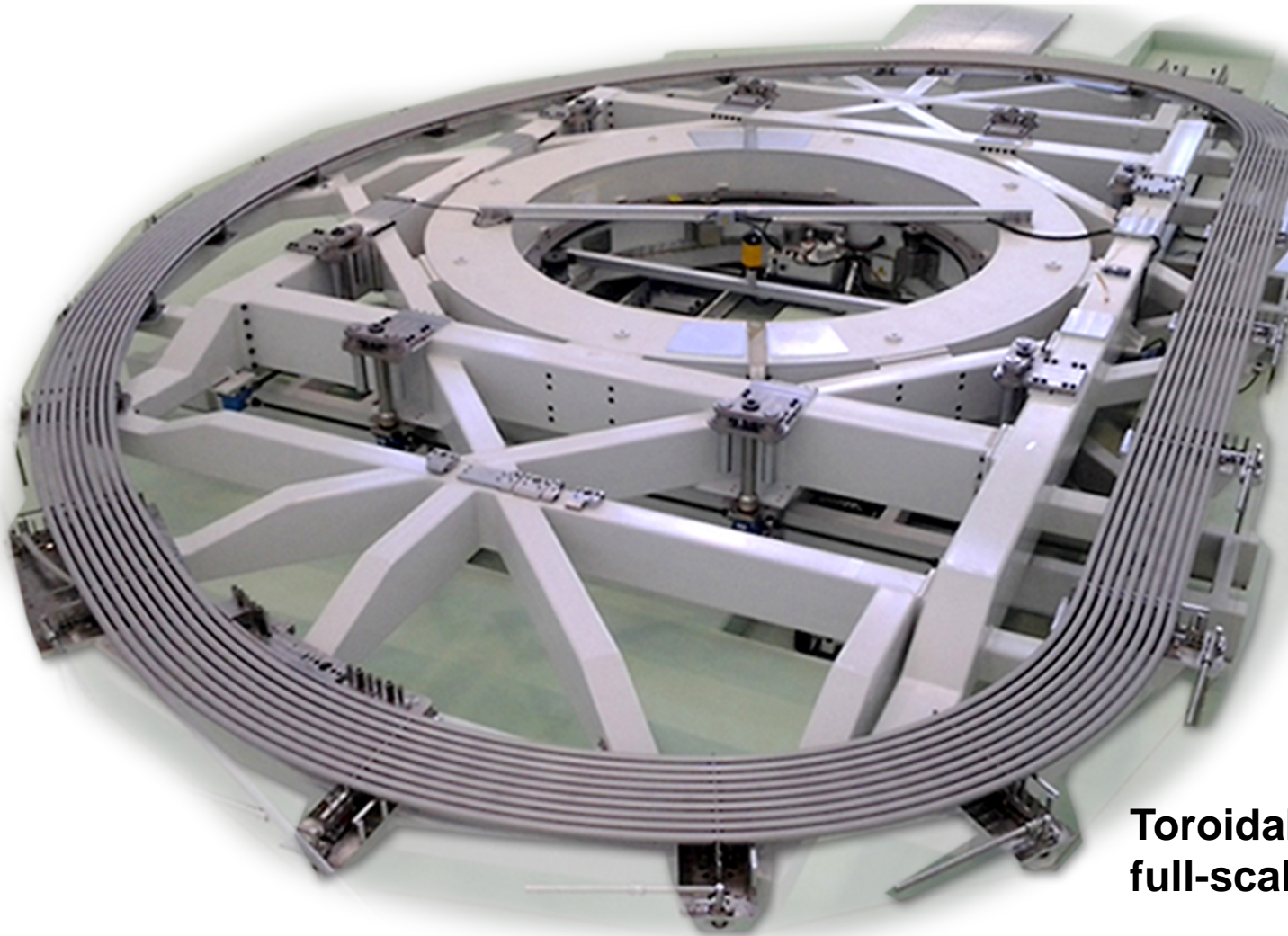

**Toroidal field conductor  
full-scale pancake**



# FY 2014 Partner Achievements

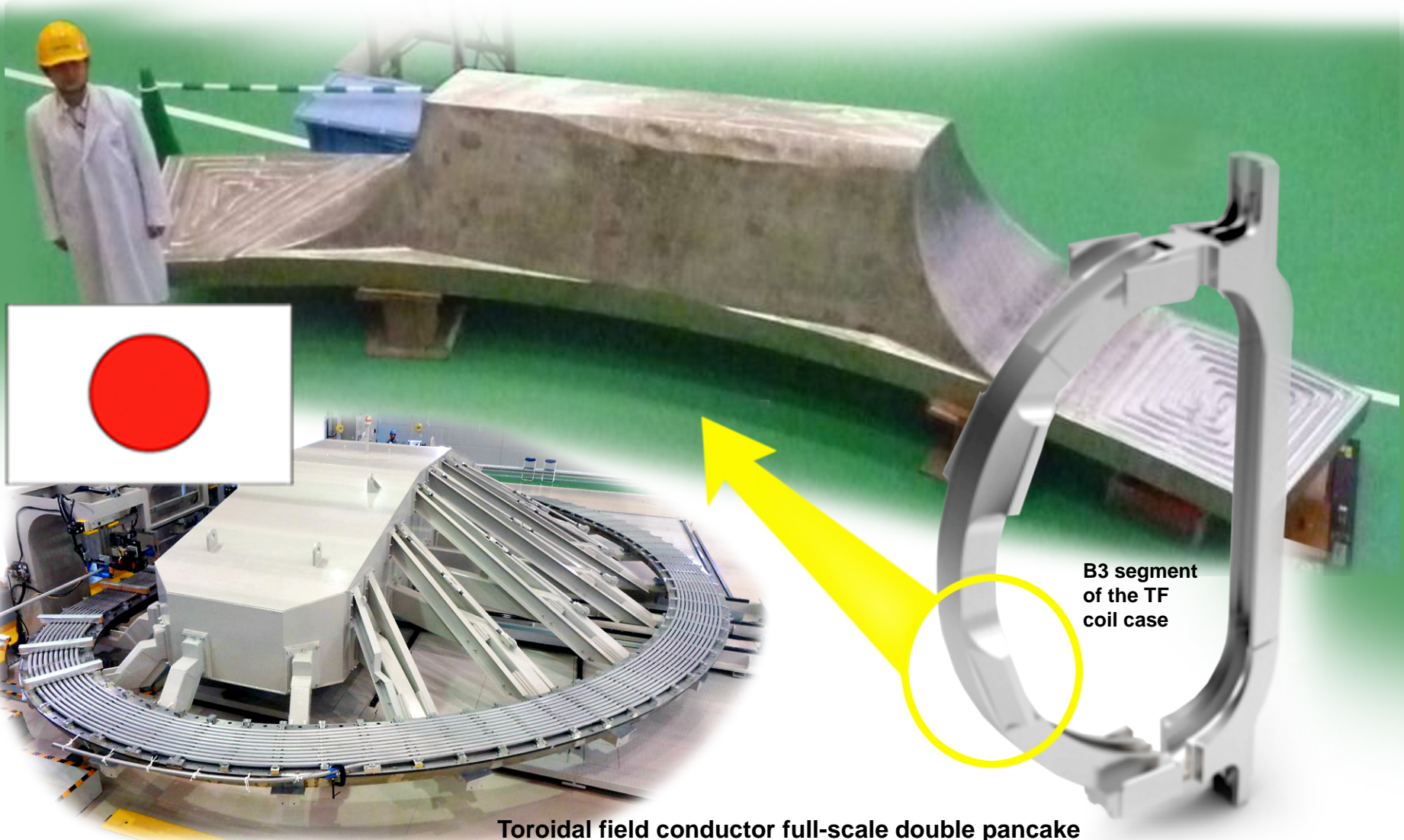

B3 segment  
of the TF  
coil case

**Toroidal field conductor full-scale double pancake**



# FY 2014 Partner Achievements

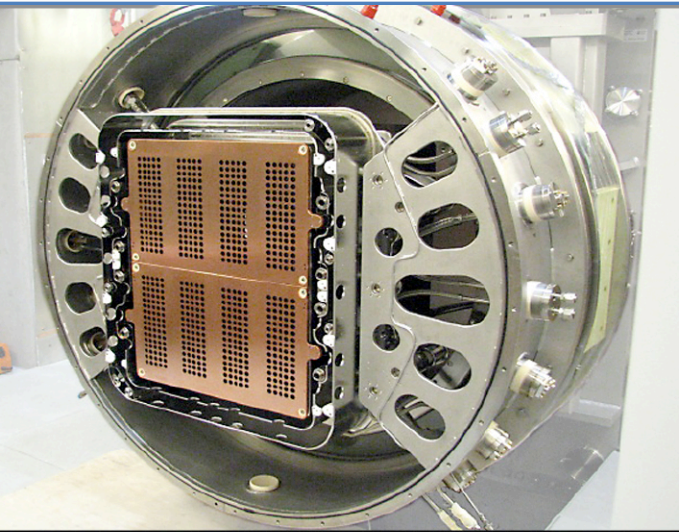

ELISE ion source at IPP,  
Garching, Germany

## Neutral beam injector test facility



Neutral beam injector test facility in Padova, Italy

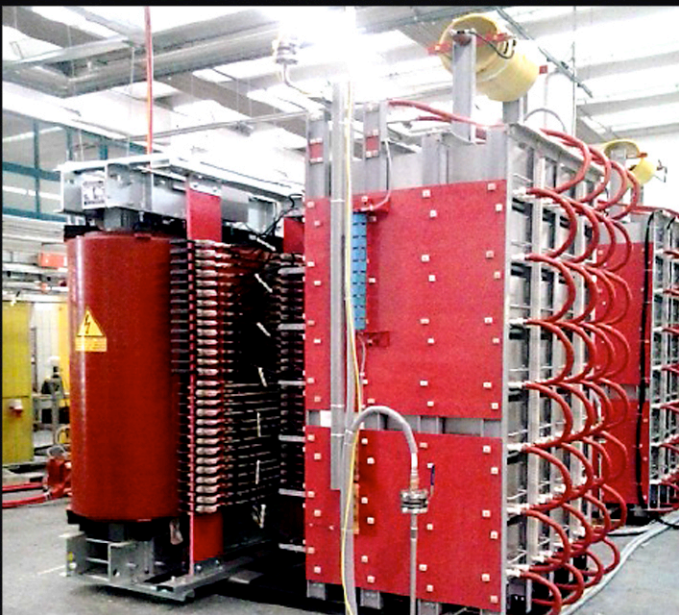

Extraction grid power supply  
in San Giorgio di Piano, Italy



# FY 2014 Partner Achievements



**Vacuum Vessel Segment**

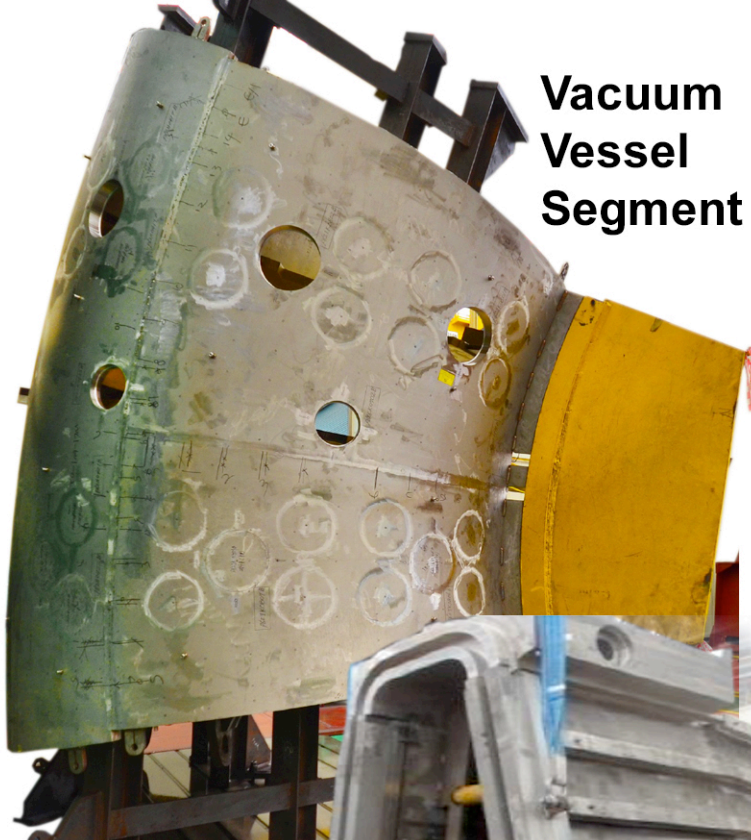

**Prototype for Vacuum Vessel**



**Vacuum Vessel Port Fabrication**



# FY 2014 Partner Achievements



Port plug testing



# FY 2014 Partner Achievements



## Prototypes for the Cryostat



**In-wall shielding  
component for  
vacuum vessel**



# FY 2014 Partner Achievements

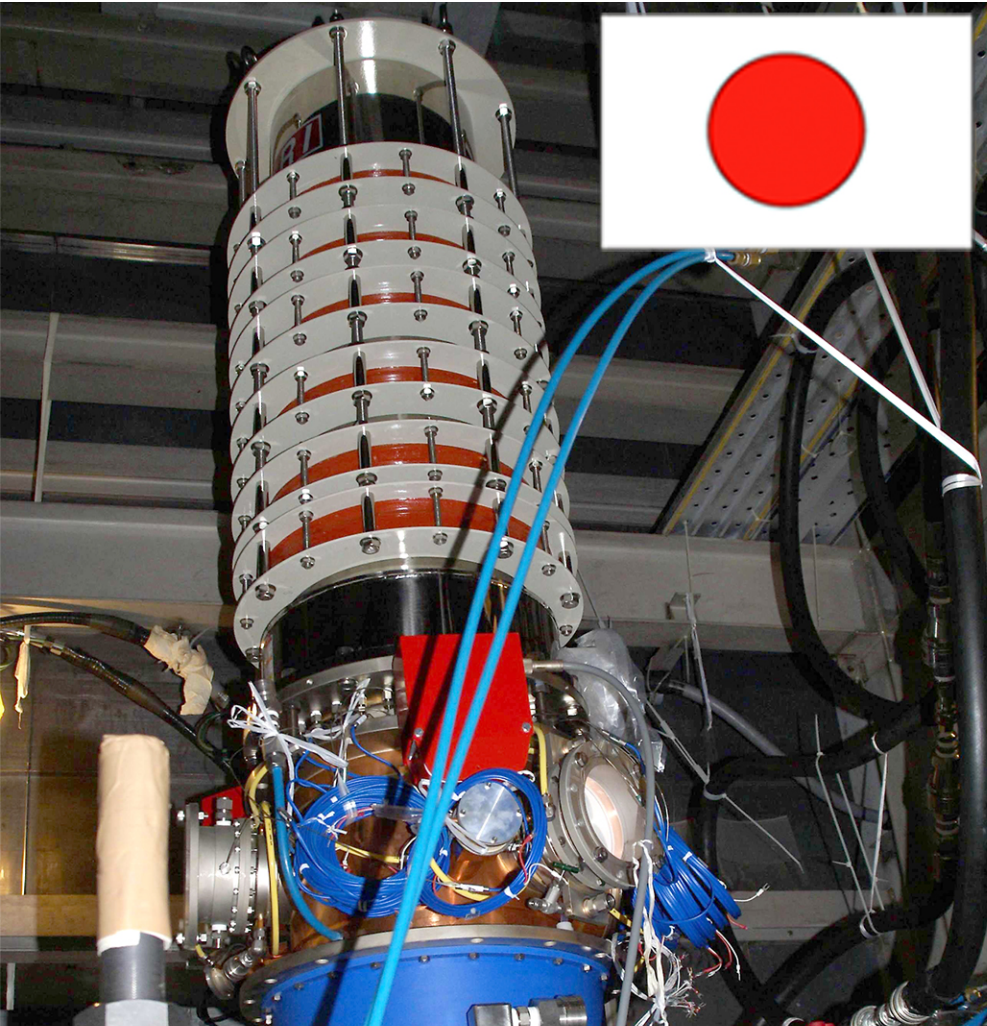

**1MW gyrotrons for plasma heating & current drive and mode suppression**



# US FY14 Status and Achievements

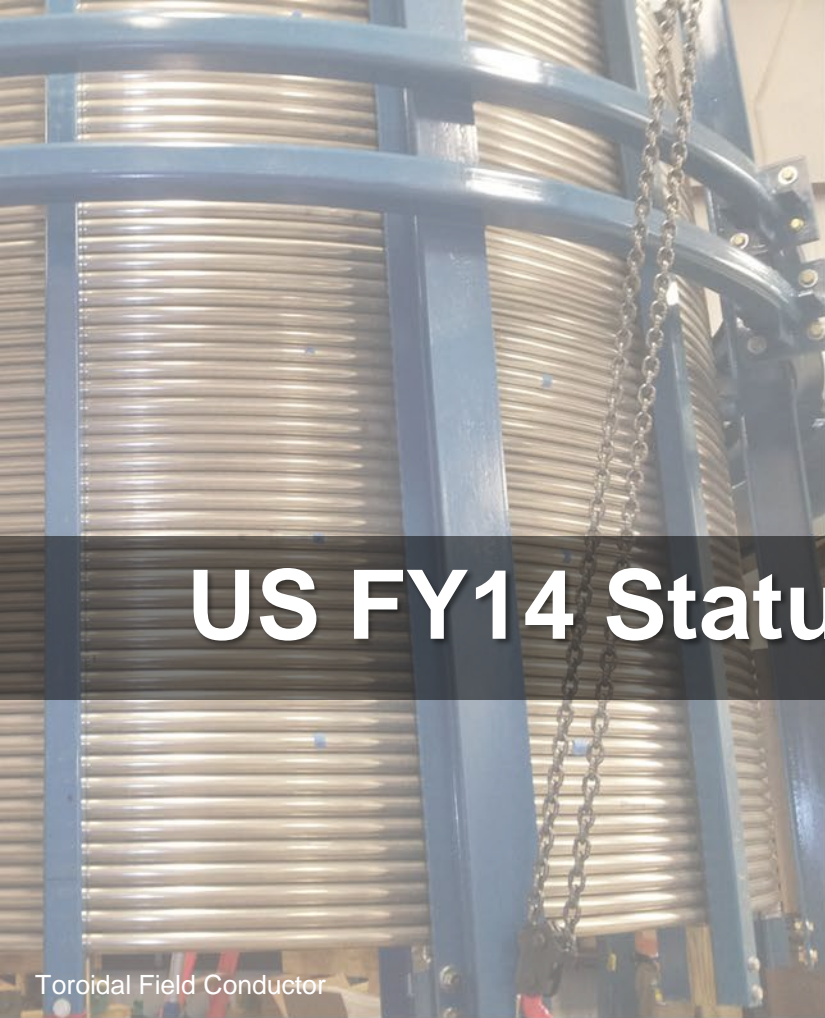

Toroidal Field Conductor



Tokamak Cooling Water System

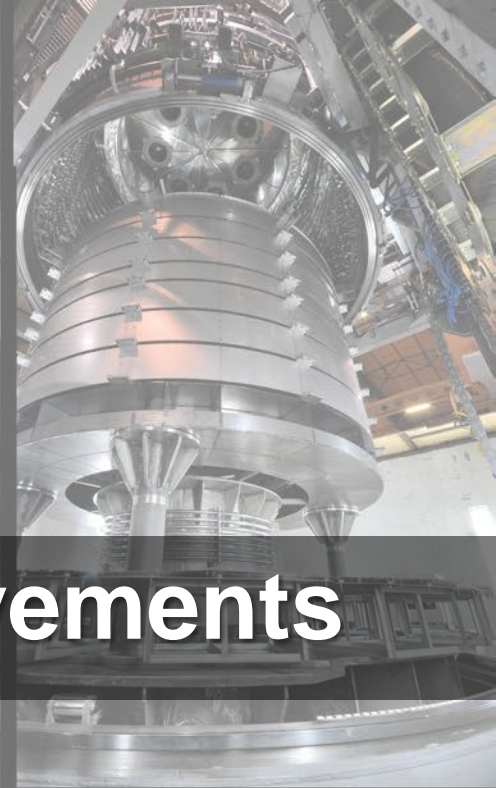

Central Solenoid



Steady State Electrical Network





# Scope Delivered in 2 Phases

## All Designs Completed Before 1<sup>st</sup> Plasma

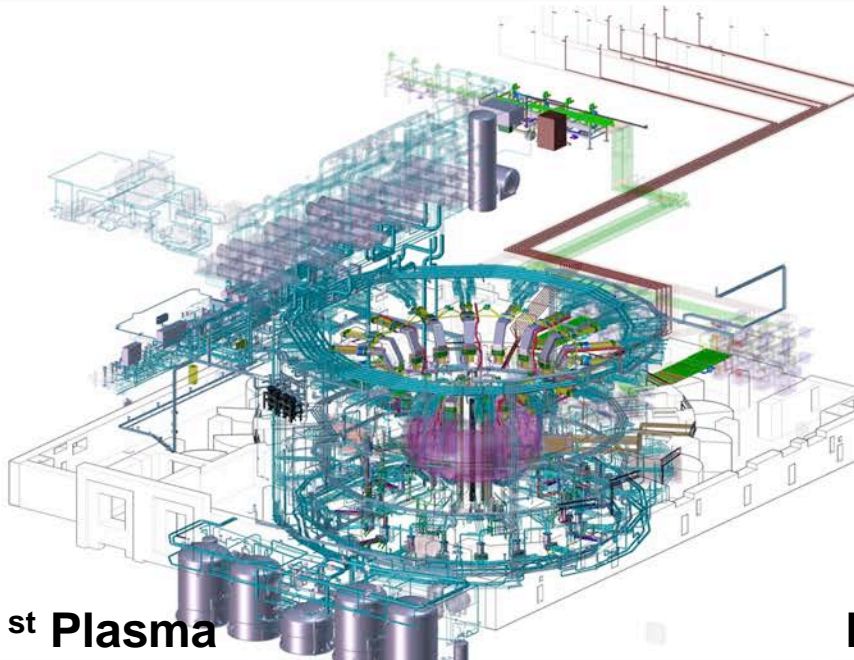

**1<sup>st</sup> Plasma**

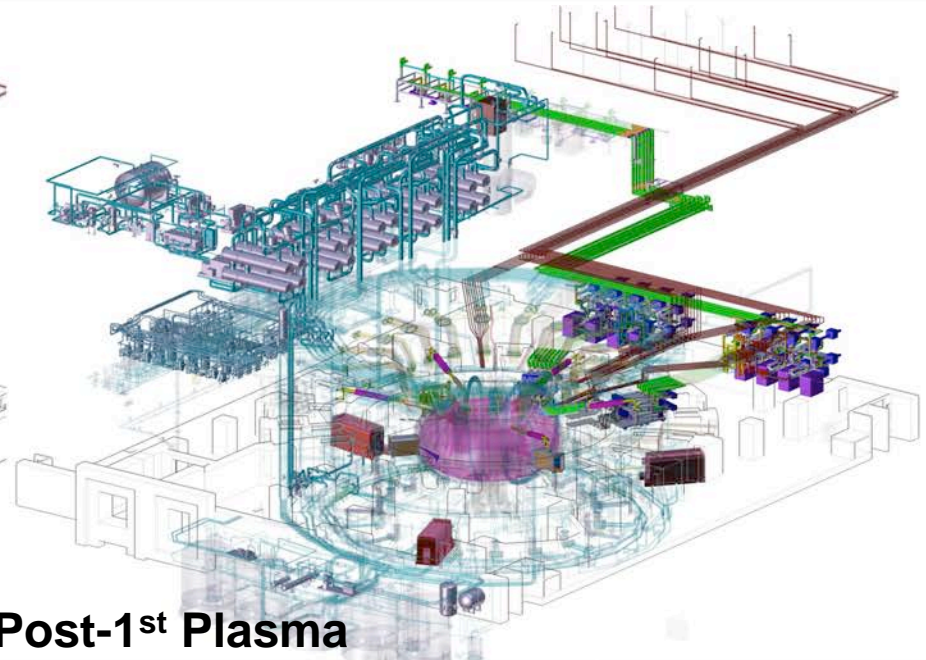

**Post-1<sup>st</sup> Plasma**

### Delivered

- Central Solenoid
- Toroidal field conductor
- Steady-state electrical network

### Partial Production

- Ion/electron cyclotron heating
- Diagnostics
- Roughing pumps
- Pellet injection
- Tokamak cooling water system
- Vacuum auxiliary system

### Completion of Production

- Ion/electron cyclotron heating
- Diagnostics
- Roughing pumps
- Pellet injection
- Tokamak cooling water system
- Vacuum auxiliary system

### Full Production

- Tokamak exhaust processing
- Disruption mitigation



# Toroidal Field Coil Conductor

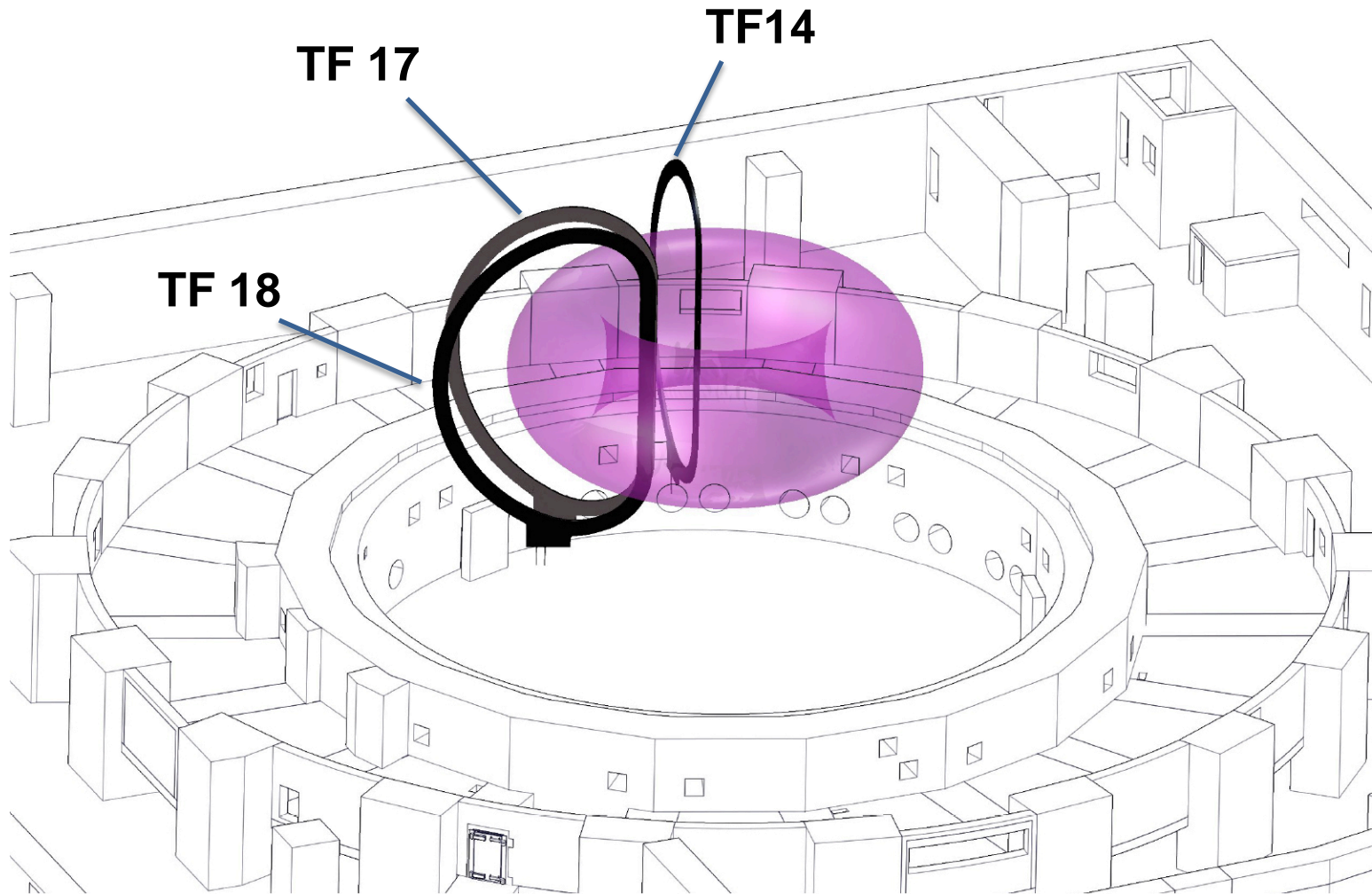



# Toroidal Field Coil

- Total Magnetic Energy of all TF Coils: 41 GJ
- Maximum Magnetic Field: 11.8 T
- Number of Coils: 18
- Total TF Coil Weight: 6540 t
- TF Coil Height: 16.5 m
- TF Coil Width: 9 m
- Operating Temperature: 5.7 K
- Current in 1 TF Coil: 9.11 MA
- Number of turns in 1 TF coil: 134

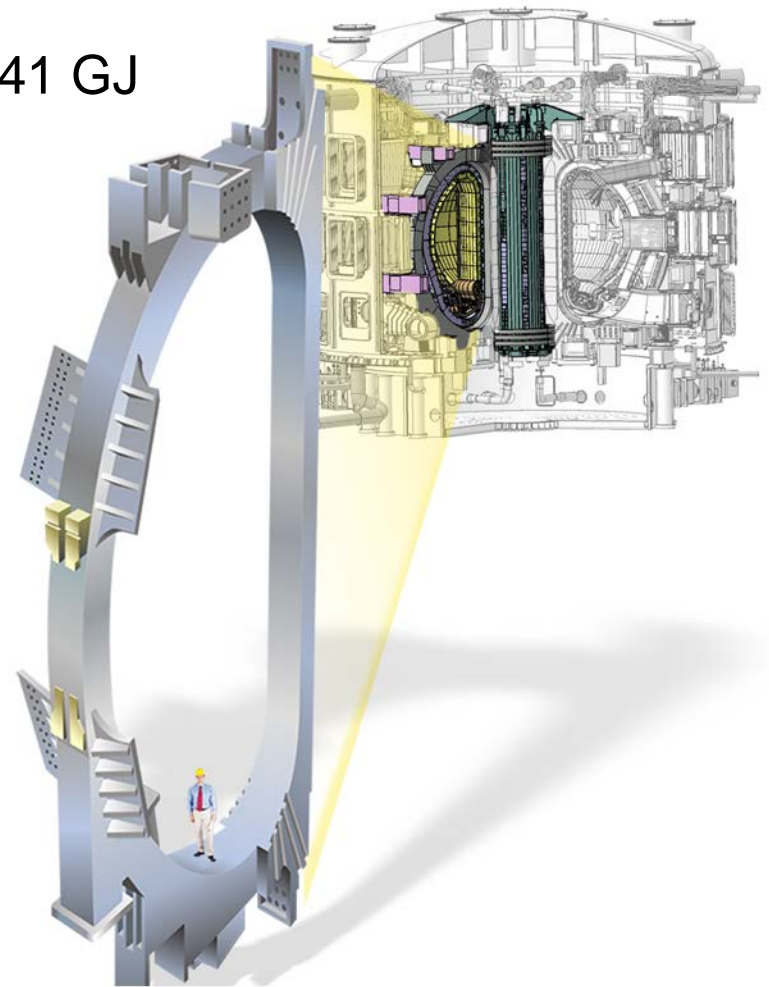



# Toroidal Field Conductor

## FY 14 Status



- US responsible for providing nine 800 m TF conductor unit lengths (8% of the total)
- Fabrication contracts
  - All of the superconducting strand (from OST and Luvata), jacket sections (e-Energy), and spiral core tubing have been provided
  - Remaining fabrication work is at NEWT for cabling the superconducting strand and HPM for integration (jacket assembly; cable insertion, compaction, and spooling; and testing)



800 m Dummy Spool shown in turn-over frame at HPM



FY 2013 US Achievement:

# Completion of Toroidal Field Strand



Production conductor strand at Luvata Waterbury Inc. in Newark, NJ



Production conductor strand at Oxford Superconducting Technology in Carteret, NJ



# FY 2014 US Achievement: Toroidal Field Cabling

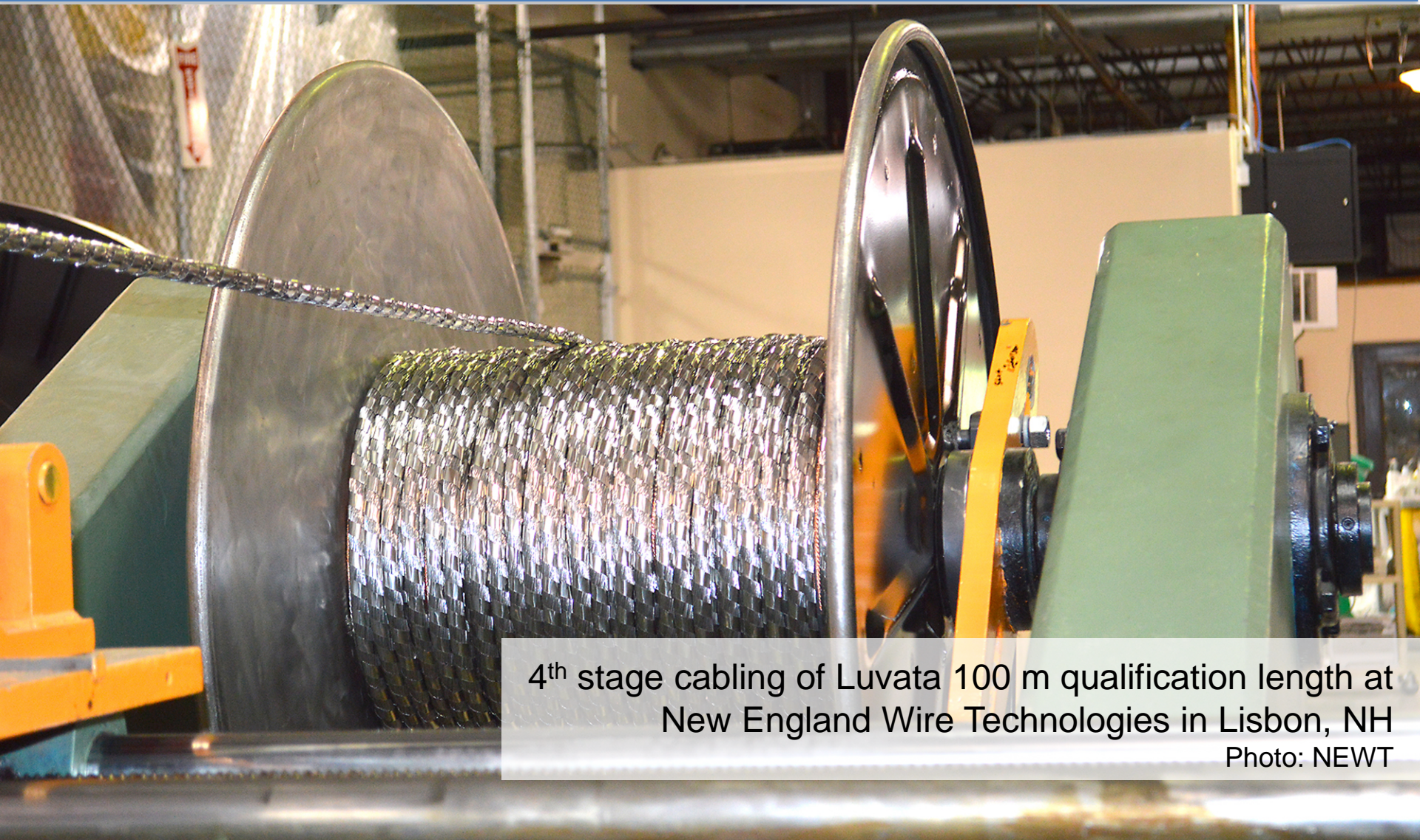

4<sup>th</sup> stage cabling of Luvata 100 m qualification length at  
New England Wire Technologies in Lisbon, NH

Photo: NEWT



FY 2014 US Achievement:

# Toroidal Field Conductor Jacketing



High Performance Magnetics jacketing and integration facility in Tallahassee, Florida  
Photo: US ITER



# FY 2014 US Achievement: Deliveries to EU Coil Winding Facility



US TF 800 m Dummy Conductor and 100 m production conductor delivered to EU winding facility

US contribution includes over 4 miles of conductor, which is constructed from 40 tons (over 4000 miles) of niobium-tin superconducting strand



Truck arriving at ASG in Italy with US TF 800 m dummy conductor



US TF 800 m Dummy Conductor - Delivery at ASG in Italy



# Central Solenoid

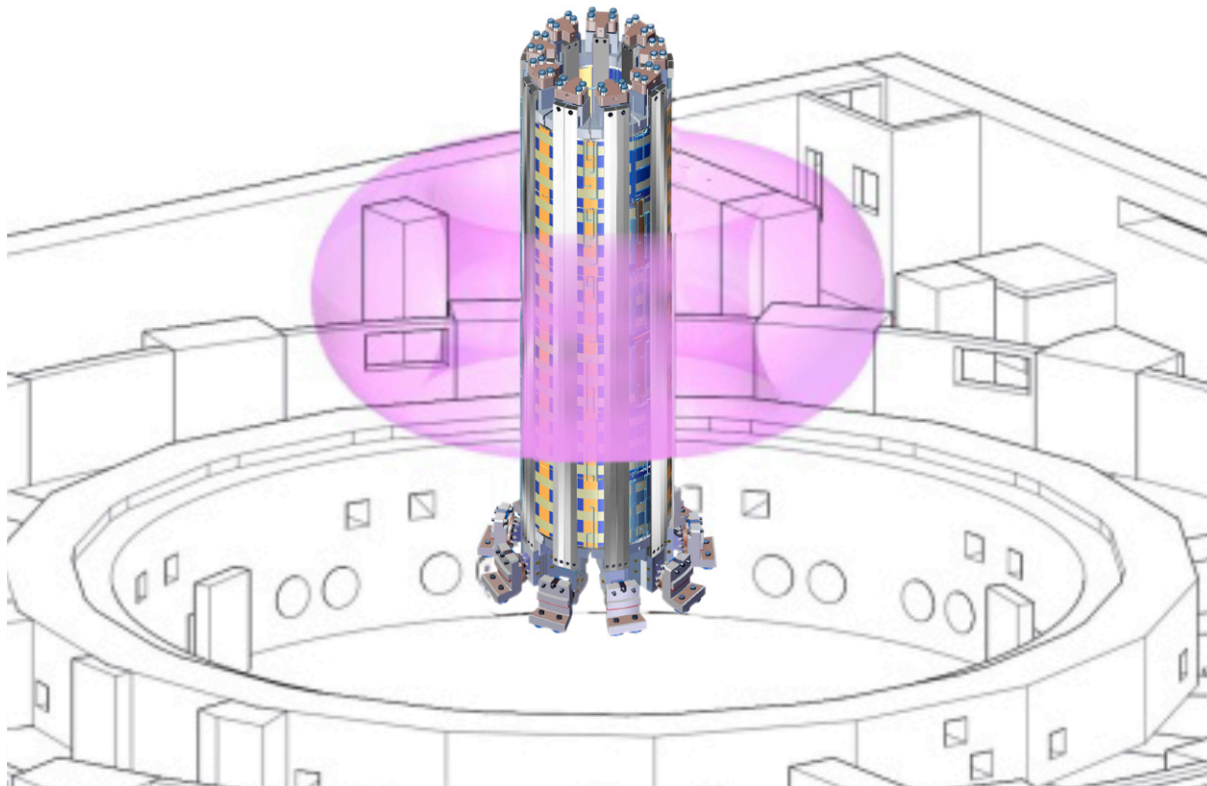



# Central Solenoid

**Coil Packs:** 6 + 1 spare  
**Field Strength:** 13 T  
**Operating Voltage:** 14 kV  
**Test Voltage:** 30 kV  
**Operating Current:** 45 kA  
**Test Current:** 50 kA (@ 4 K)

**1,000 metric ton magnet induces the majority of magnetic flux charge needed to initiate and maintain plasma current**

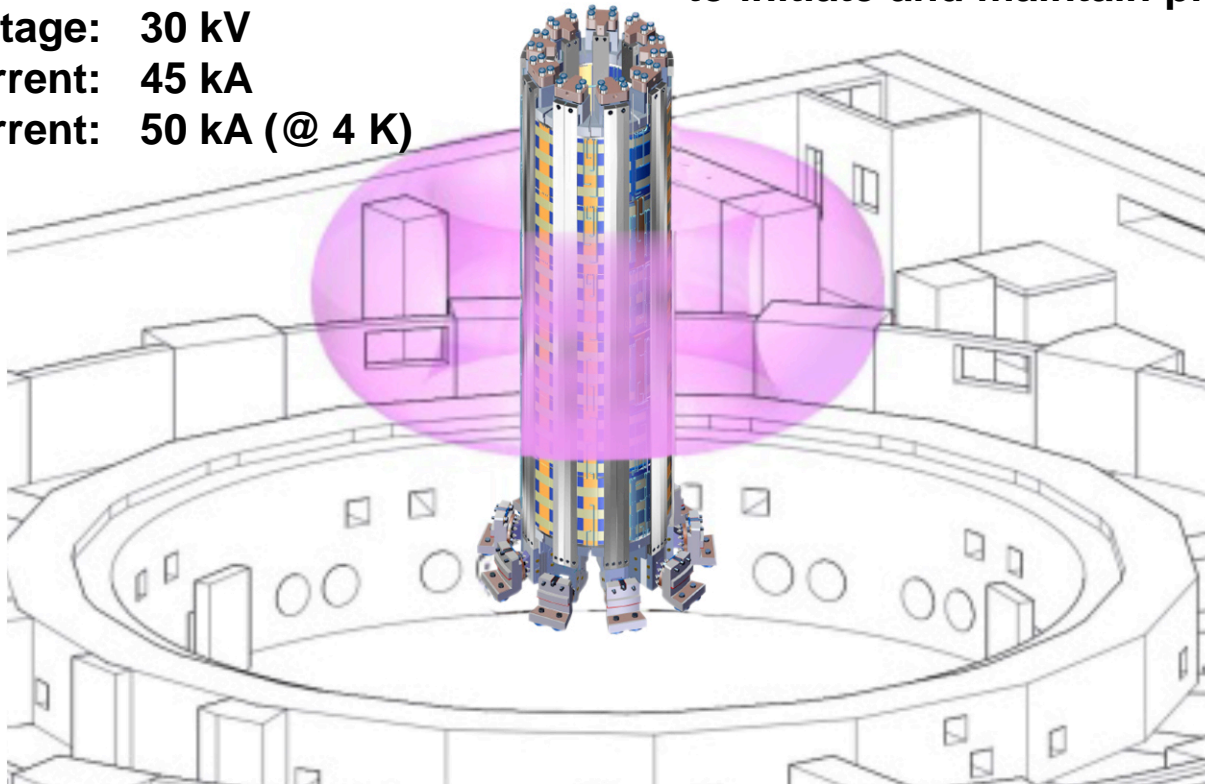

**The most powerful pulsed superconducting electromagnet in history  
(5.5 Gigajoule stored energy capacity)**



# Central Solenoid (CS)

## FY 14 Status



- Successful FDR in Nov 2013
- Completed design modifications based on FDR feedback
- Final 3D model submitted to IO
- Final design documentation (specifications, drawings, and analysis reports) being submitted for IO approval
- Completed Manufacturing Readiness Review (MRR) for winding station
- Began winding mock-up coil

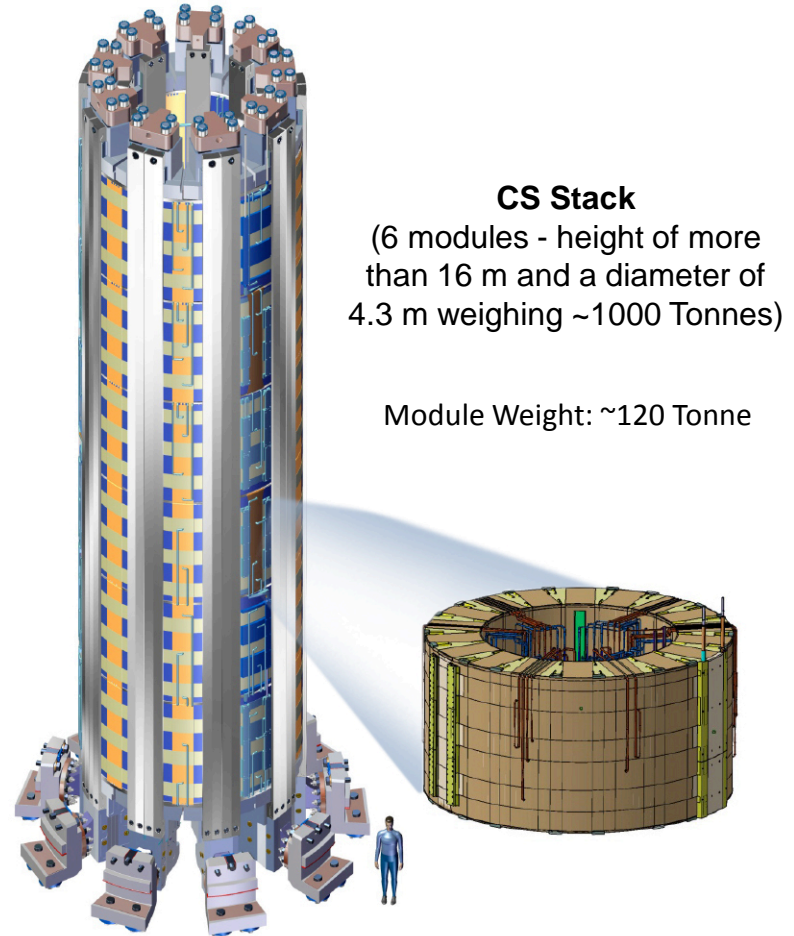



# FY 2014 US Achievement: Module Tooling Stations are Being Installed at General Atomics



1: Conductor receiving inspection



2: Winding (2)



3: Joints & Terminals Preparation



4: Stack and Join/ Helium Penetrations



5: Reaction Heat Treatment



6: Turn Insulation



7: Ground Insulation



8: Vacuum Pressure Impregnation

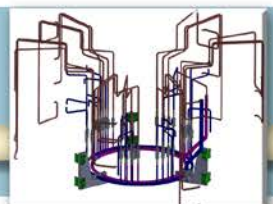

9: Helium Piping & Measurement



10: Final Test at 50kA, full force

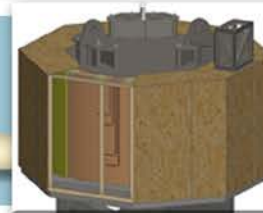

11: Shipping

**Transfer  
Ownership**



# FY 2014 US Achievement: 1<sup>st</sup> Winding Station Installed



**MRR Conducted in July 2014**



**De-spooler**



**Tractor drive and straighteners**



**Grit blast and cleaning**



**Forming head**

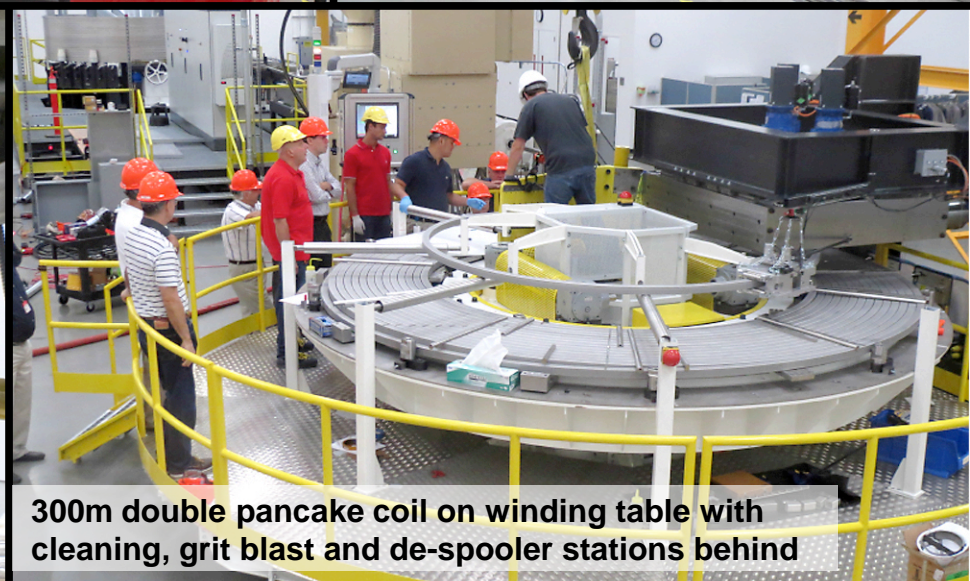

**300m double pancake coil on winding table with cleaning, grit blast and de-spooler stations behind**





Dummy conductor shown loaded on winding machine – in prep for mock-up winding

4 central solenoid active conductor spools and 1 dummy at General Atomics



# Mock-up Winding Has Begun



Conductor routed from de-spooler

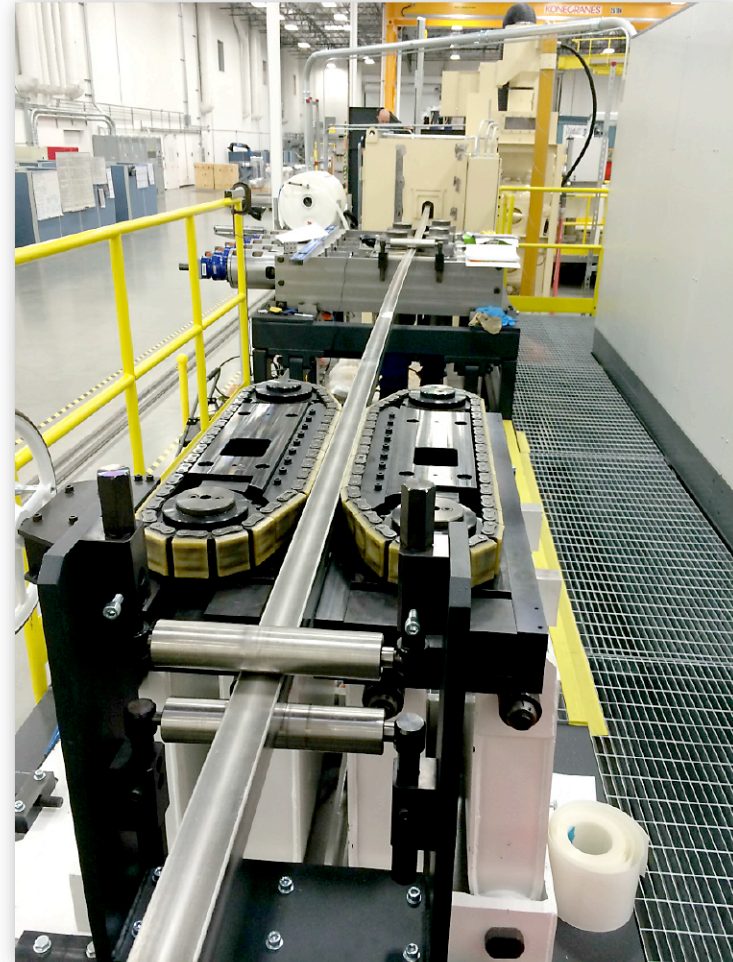

Conductor routed through straightener





**Specifications for heat treatment furnace:**

- Height – 7 m
- Diameter – 5.56 m
- Weight – 132 Tonnes (including Module)
- Power 800 kW
- Medium – Argon
- Pressure –  $1 \times 10^{-2}$  mbar



**Heat treatment furnace and associated equipment being installed at General Atomics.**



- Factory acceptance testing completed at vendors
- Units will be re-assembled and commissioned using mock hexapancake

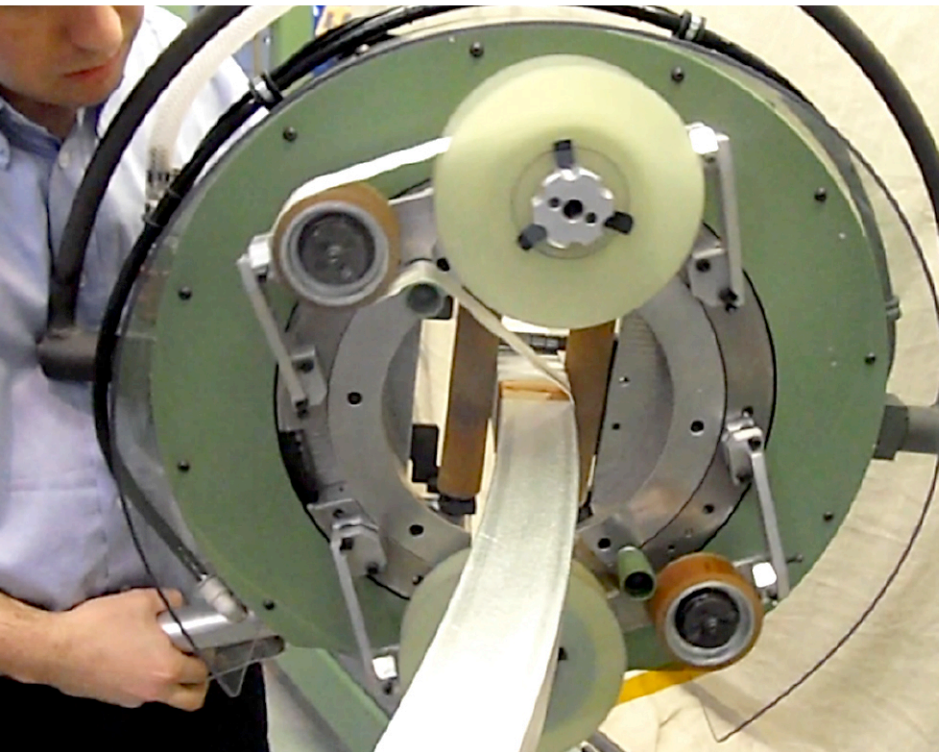

Automated taping heads from Ridgeway have been delivered to GA.



# Central Solenoid Structures

## FY 14 Status



- Successful FDR in Nov 2013
- Placed first production contract with Peterson (Ogden, UT) for lower key blocks and isolation plates
- Issued RFP for tie-plate procurement

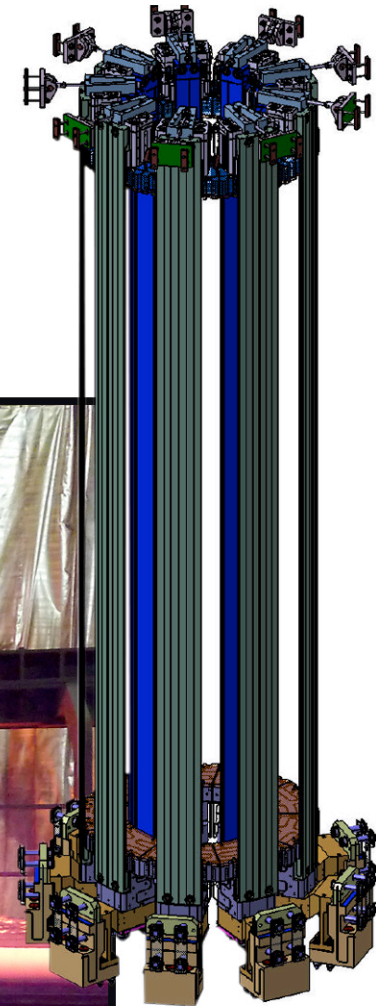
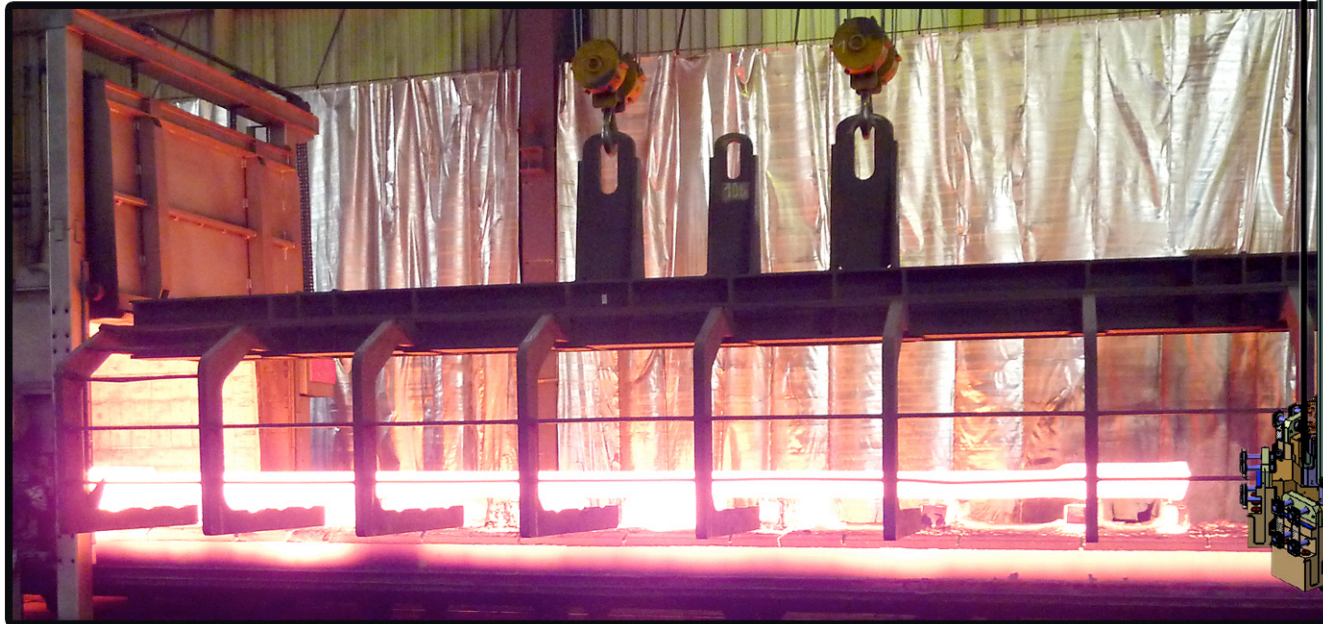

One piece tie-plate prototype forged at Kind LLC (Gummersbach, Germany)



# Central Solenoid Assembly Tooling

## FY 14 Status



- Completing the final design for the early need fixtures (assembly platform, module rotating fixture, and module lifting fixture)
- FDR for early need fixtures in September 2014

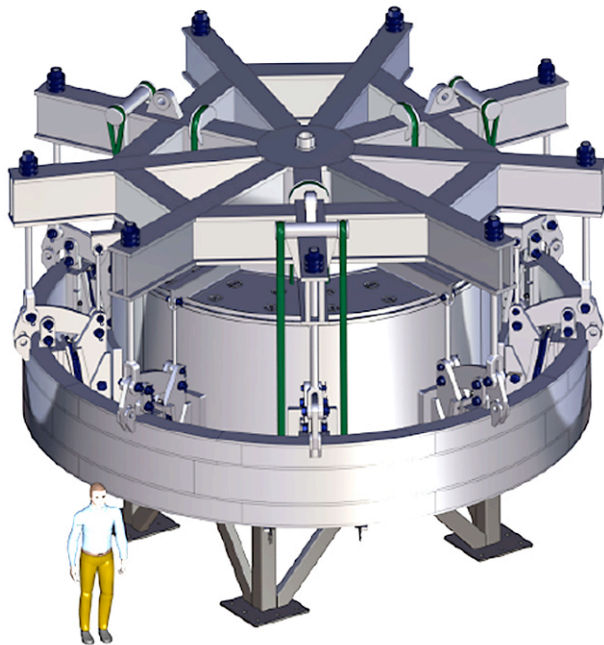

**Module Lifting Fixture**

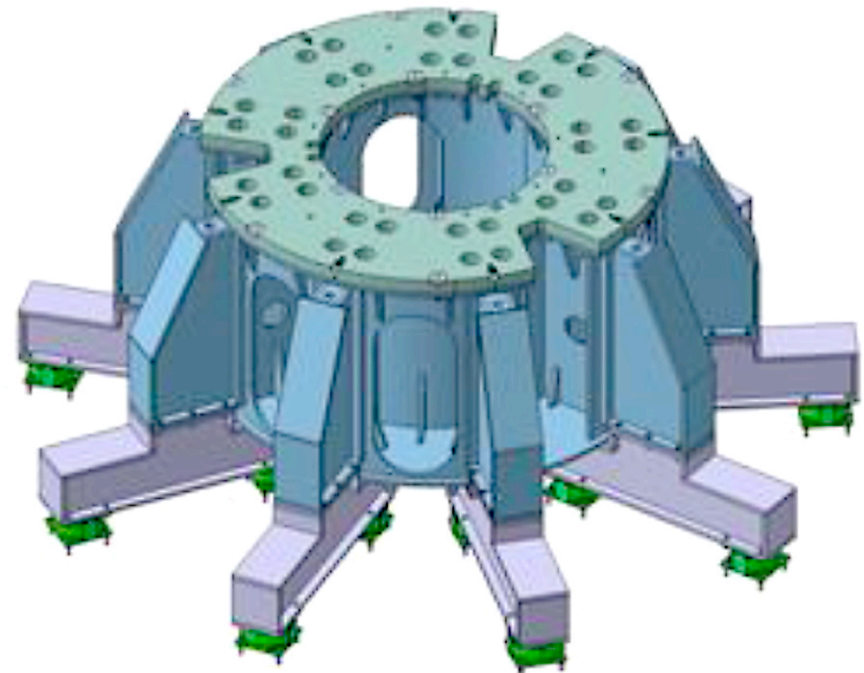

**Assembly Platform**



# Tokamak Cooling Water System

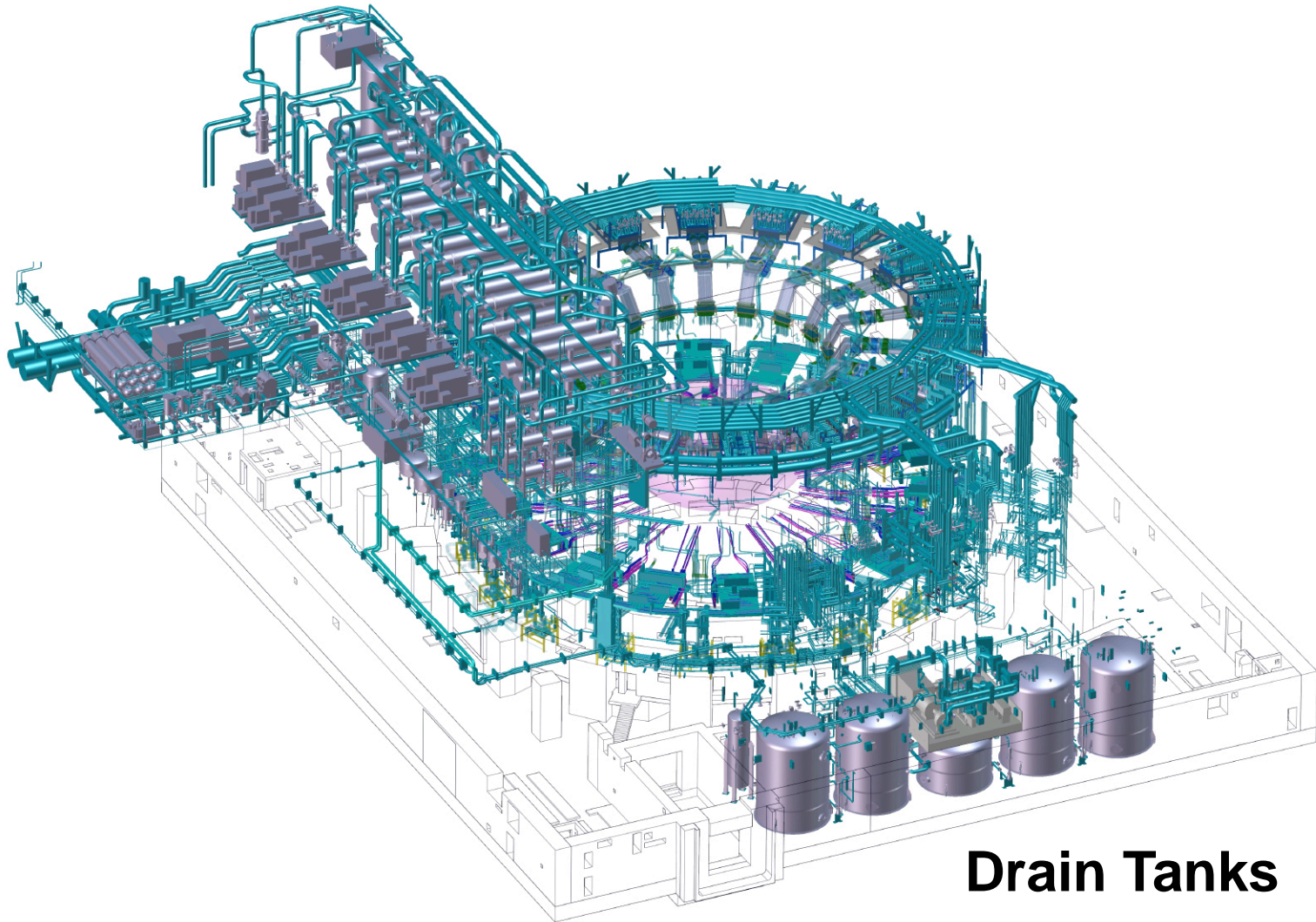

**Drain Tanks**



# Tokamak Cooling Water System



- Total installed heat removal capacity: 1,000 MW (thermal)
- 100+ major industrial pieces of equipment operating with maximum design temperatures of 400 °C (gas) and maximum pressure of 5 MPa (water @ 240 °C)
- Max coolant operating temperature: 126 °C (plasma), 240 °C (baking), 350 °C (gas baking)
- Max design pressure: 5.0 MPa
- Radioactive water storage capacity: over 1,000,000 L

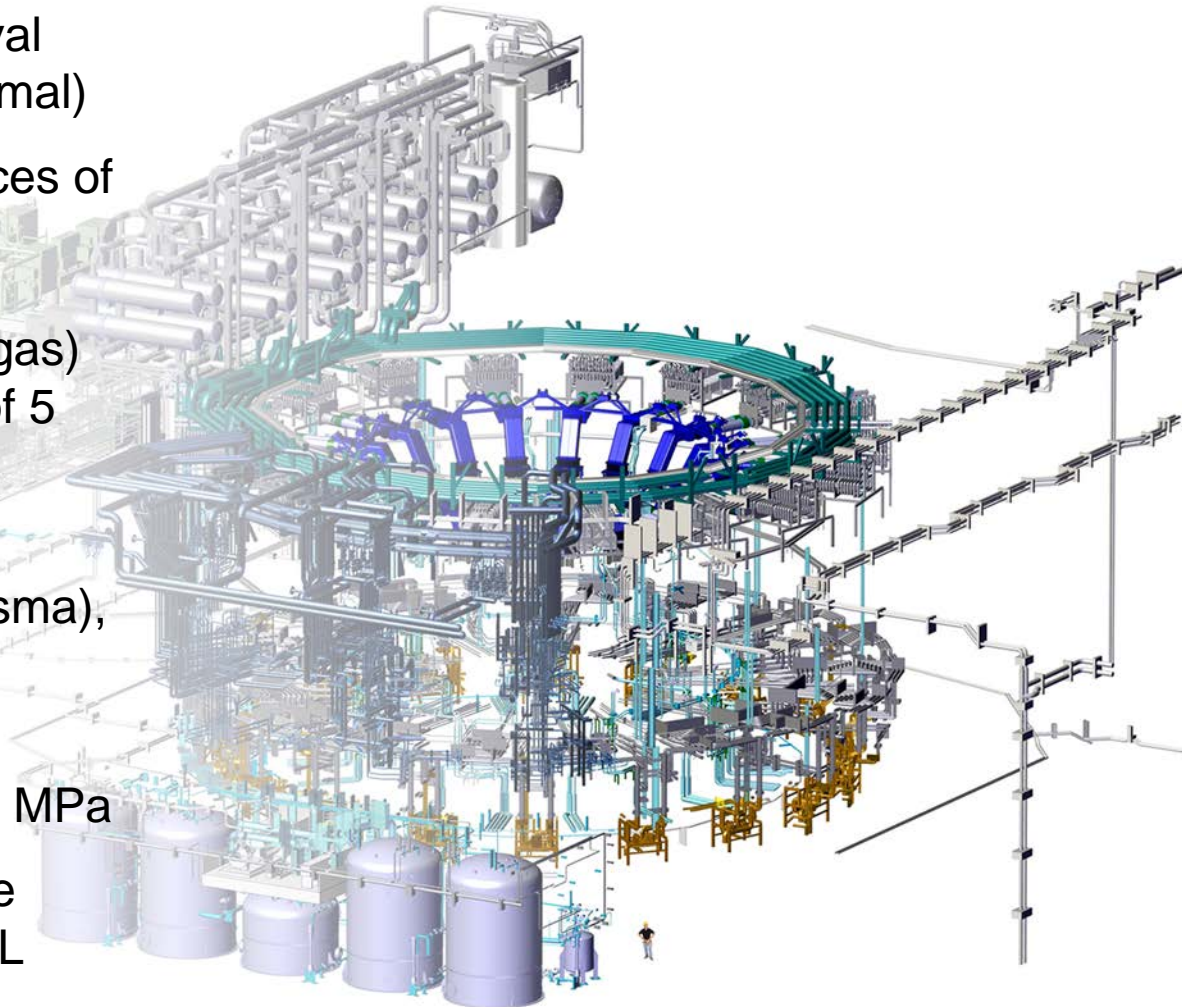



# Tokamak Cooling Water System (TCWS) FY 14 Status



## **Configuration:**

36 km (22 mi) of piping, ~230 pieces of equipment, safety important for the confinement of radioactivity

## **Status:**

In fabrication: Drain tanks

In final design: Integrated system and equipment

## **Recent Achievements:**

- Drain tank fabrication progressing and scheduled for completion in 2014
- First tank fabrication completes this month
- Shipment to the site in early 2015
- Arrangements between US ITER and the ITER Organization to complete the final TCWS design, and procure and pre-fabricate piping on behalf of US ITER





# Drain Tanks in the Tokamak Building

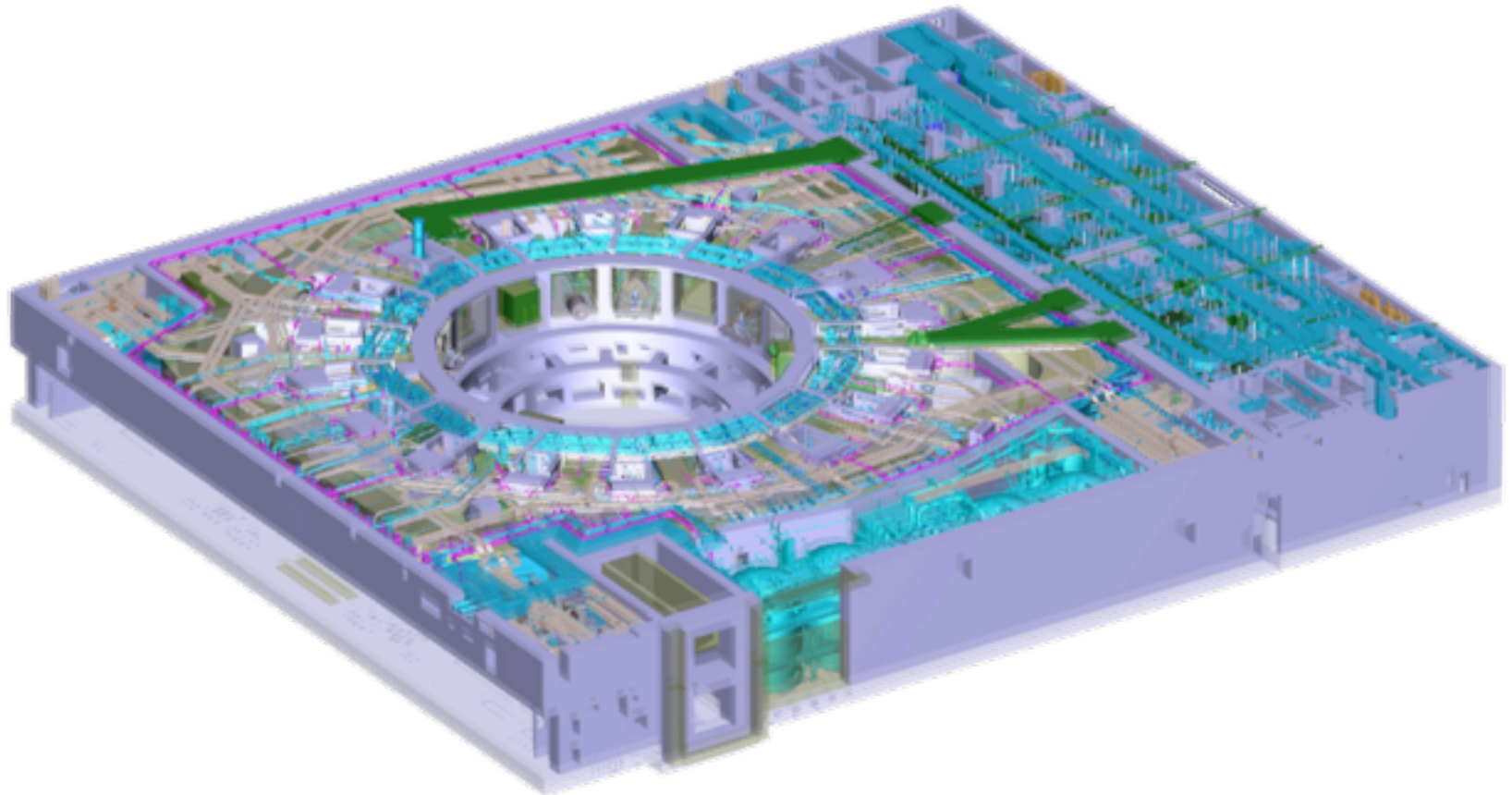



# TCWS Arrangement with IO for “Captive Piping”



- US scope defined in PA
  - Piping and equipment design, configuration management, fabrication, and delivery
- “Captive piping” and 1<sup>st</sup> Plasma design effort is priority
- Ongoing “design optimization” efforts (heat exchanger example)
- US and IO “Arrangement” to deliver final design / “captive piping” by IO

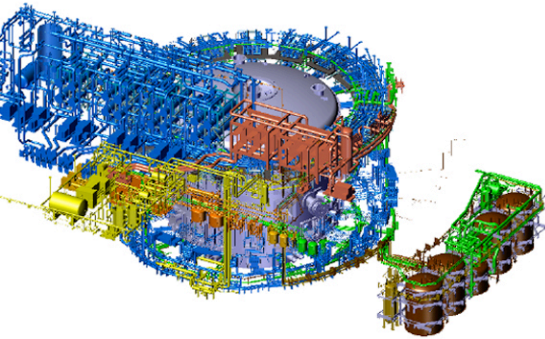

**Full System**

Managed by USDA

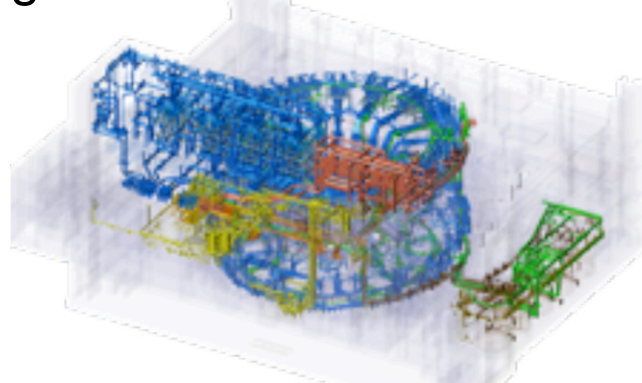

**Design & Piping**

Multiple (16) Contracts  
Managed by ITER IO  
Review by USDA

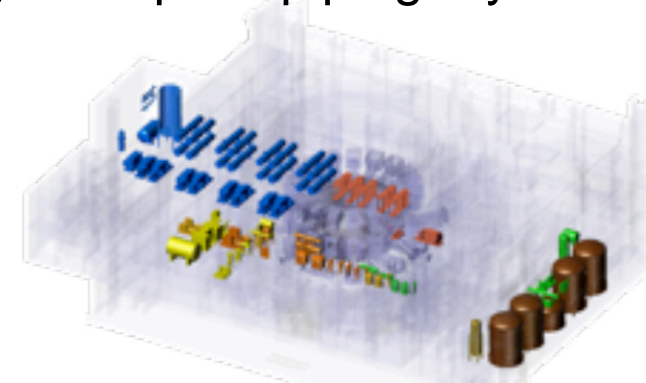

**Equipment**

Fabrication Contract(s)  
Of 100+ major pieces  
managed by USDA



# Tokamak Cooling Water System

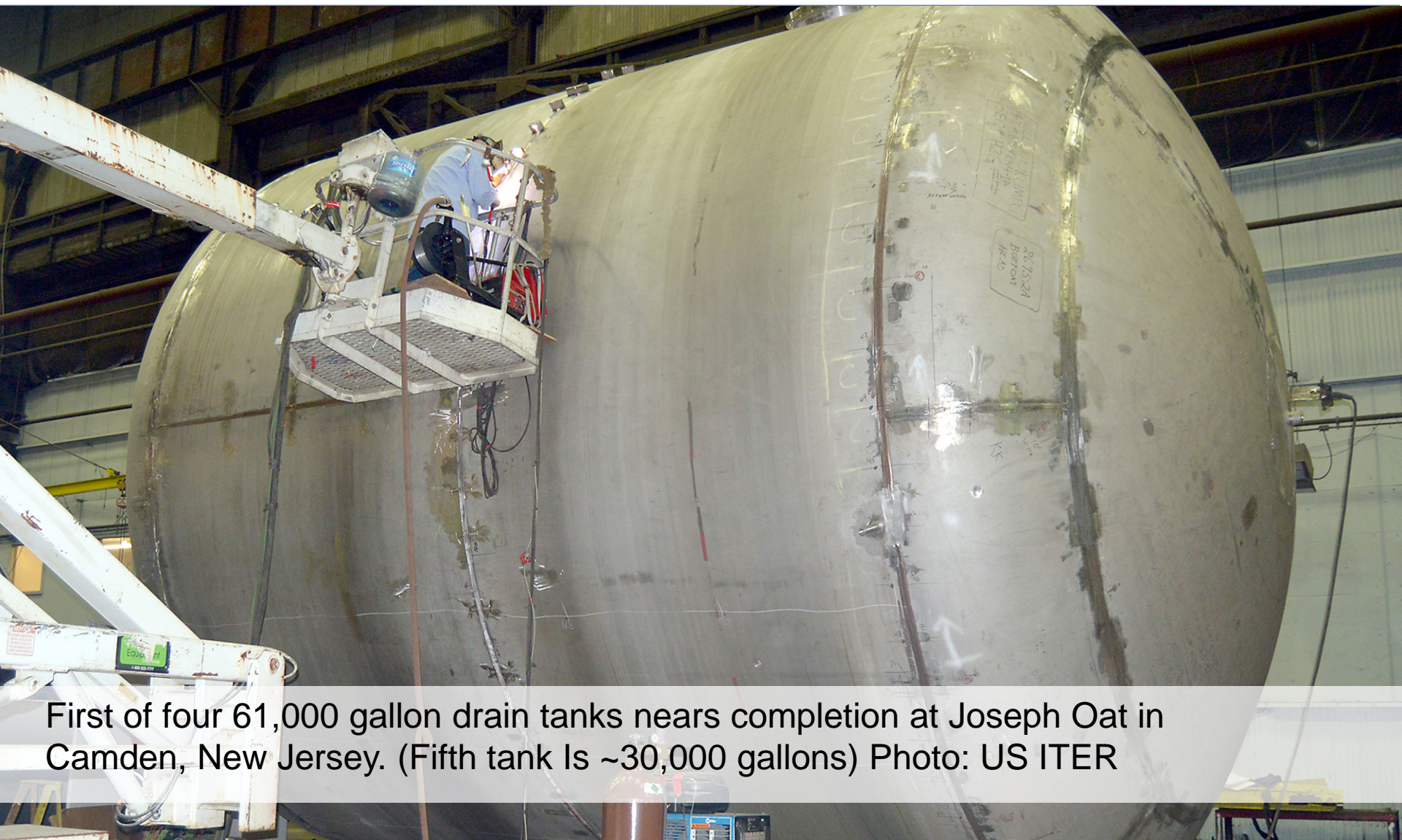

First of four 61,000 gallon drain tanks nears completion at Joseph Oat in Camden, New Jersey. (Fifth tank is ~30,000 gallons) Photo: US ITER



# Steady State Electrical Network

4 power feeds:

- 2 at 6.6 kV distribution
- 2 at 22 kV distribution

Standards: International Electrotechnical Commission standards for 50Hz operation





# Steady State Electrical Network (SSEN) FY 14 Status

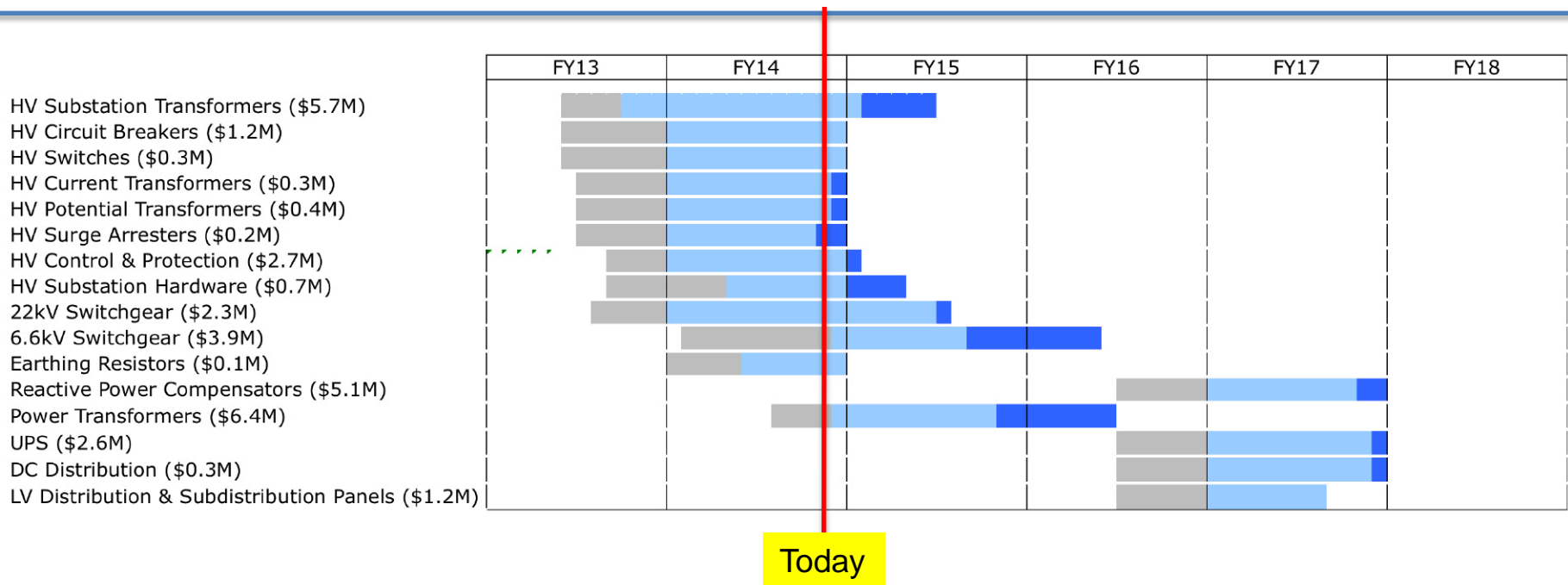

- 11 of 16 procurement have been awarded, total value ~ \$33M (FY14 unescalated)
- Deliveries have started; 400kV HV Substation delivery dates based substation construction starting 10/1/14 and energization on 10/1/15, others to support timeline of commissioning of ITER subsystems
- Remaining procurements timed to avoid contract awards in FY15
- All shipments will be completed by the end of FY17



# FY 2014 US Achievements: Steady State Electrical Network



First of four HV substation transformer units undergoing factory acceptance tests at the Hyundai Heavy Industries factory in Ulsan, Korea



One of four sets of 400kV, 3-phase HV circuit breakers undergoing factory acceptance test at Alstom SAS, Villeurbanne, France



One of four 400kV, 3-phase HV disconnect switches undergoing factory acceptance tests of the Alstom SpA factory in Noventa di Piave, Italy



# FY 2014 US Achievements: Steady State Electrical Network



High voltage surge arresters were the first plant components delivered to the ITER site, on September 4, 2014. Photo: ITER Organization



# Pellet Injection and Disruption Mitigation Systems

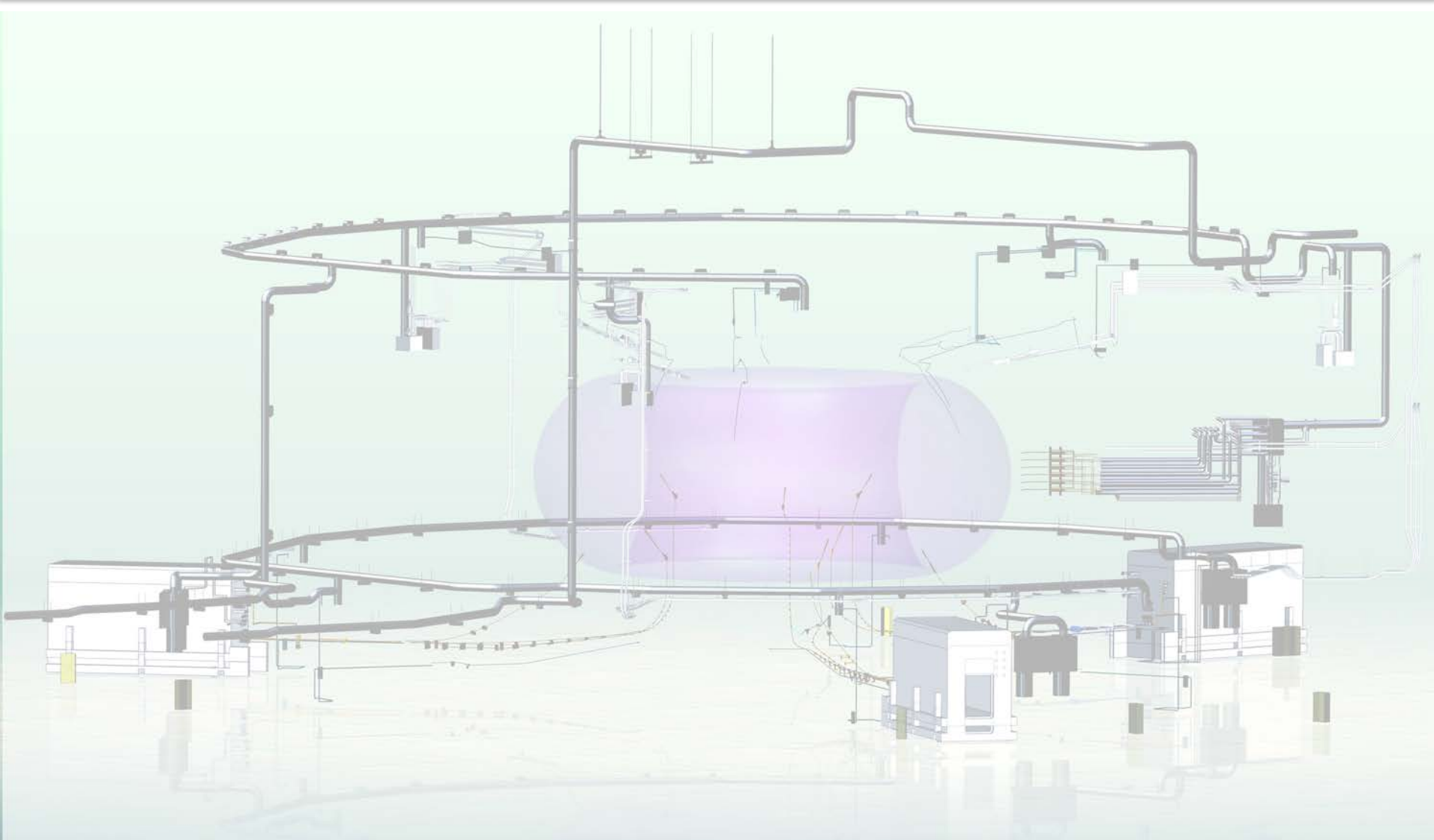



# Pellet Fueling and Pellet Pacing

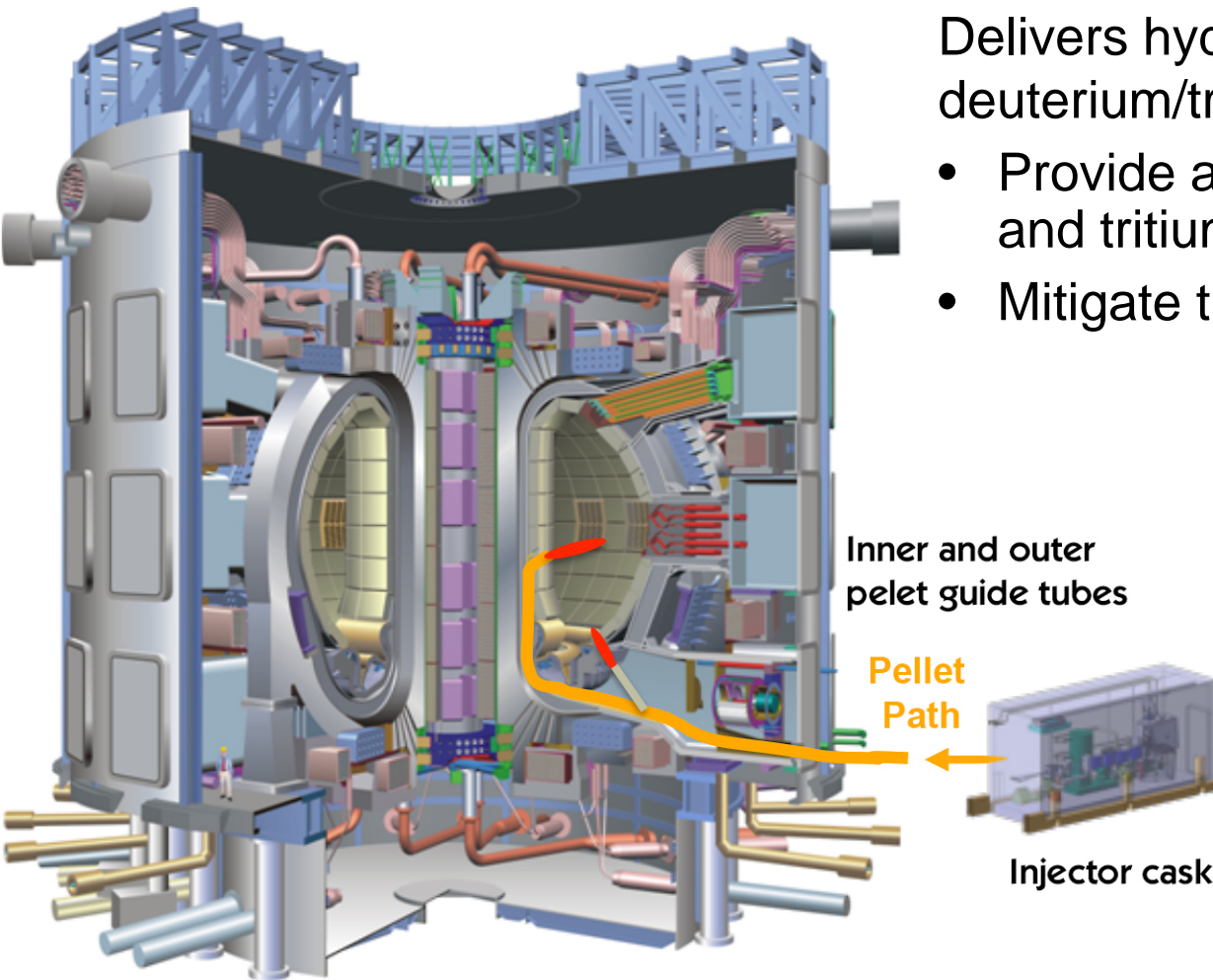

Delivers hydrogen, deuterium and deuterium/tritium pellets to:

- Provide a steady supply of deuterium and tritium fuel
- Mitigate the impact of ELMs

## Configuration:

- Two pellet injection casks with dual injectors in each cask
- Guide tubes to inner and outer wall locations
- Guide tube selector to route pellets as needed



# Disruption Mitigation System

## Requirements:

- Rapid plasma thermal quench to mitigate localized heat loads (response time  $\sim 10$  ms)
- Plasma current quench to mitigate mechanical loads (response time  $\sim 200$  ms)
- Suppress or dissipate runaway electron current (response time  $\sim 500$  ms)

## Configuration:

- Shattered pellet injector (SPI) located in upper port cell with pellet shattered near plasma edge
- SPI has multiple barrels for redundancy and injection adjustment
- Massive gas injection (MGI) valves located in equatorial port cell

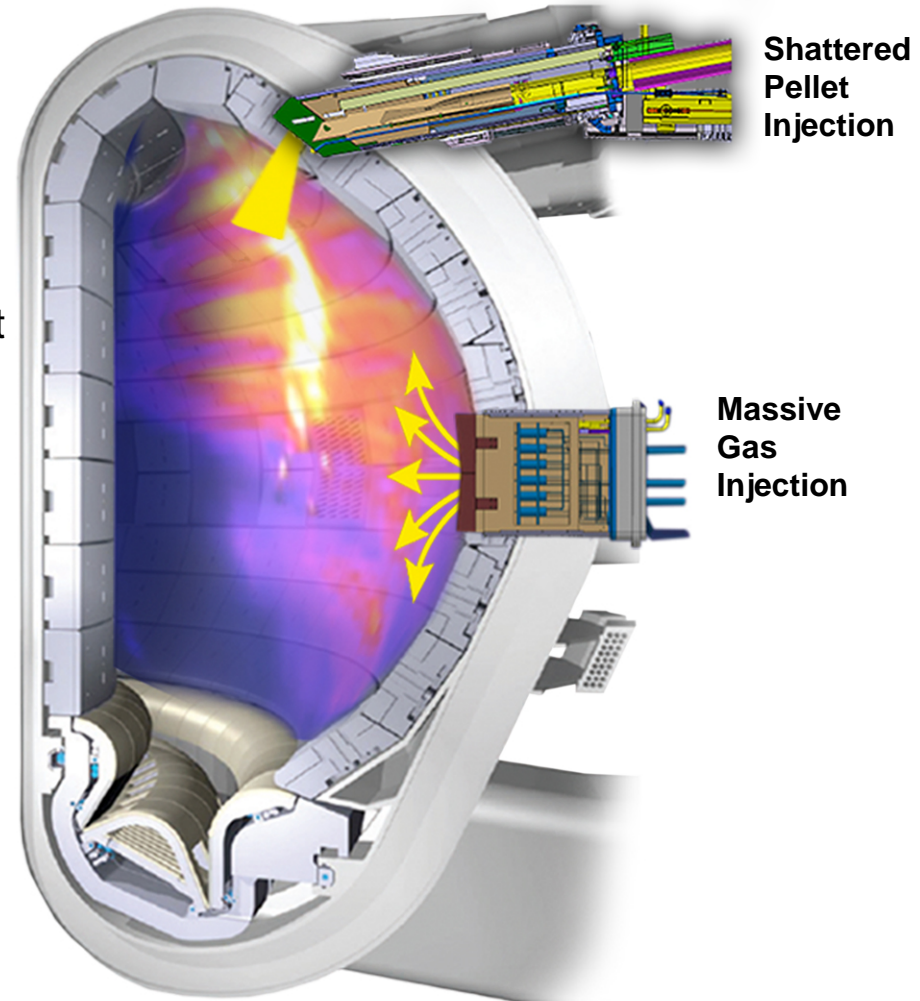



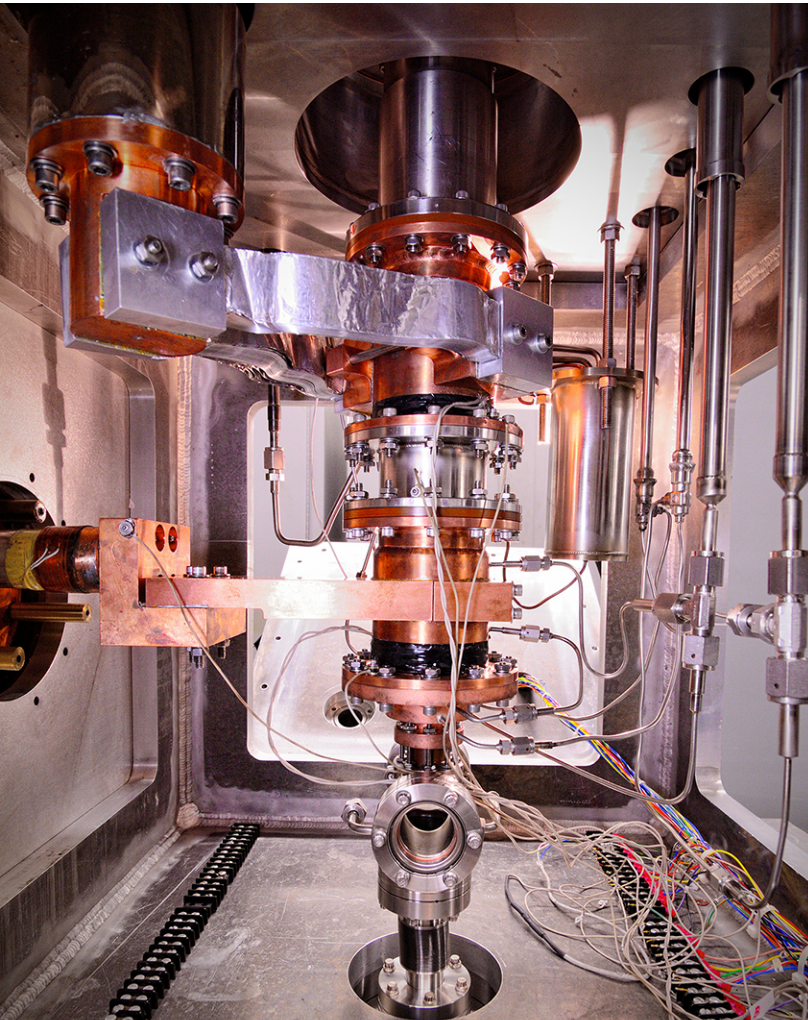

Twin-screw pellet extruder

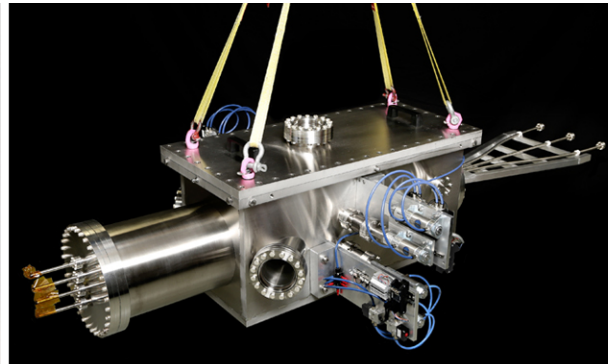

Pellet guide tube selector test unit

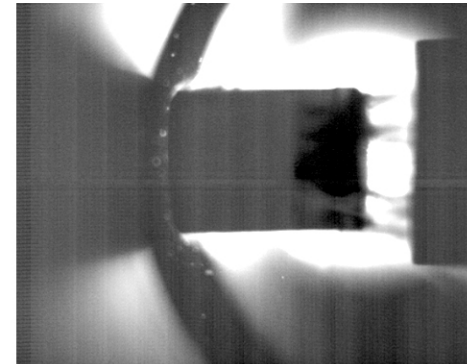

Deuterium-neon pellet formation testing

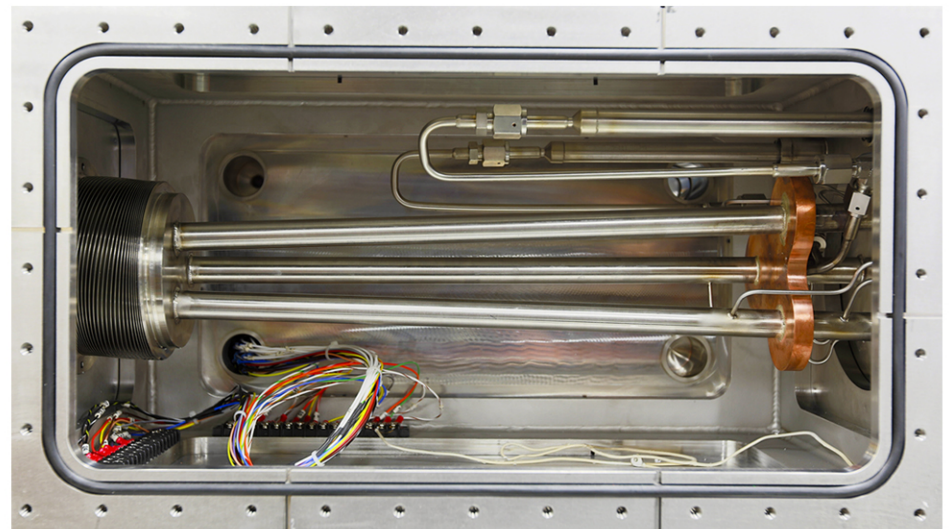

3-barrel unit prototype for disruption mitigation



# Pellet Fueling and Pellet Pacing

## Status:

In design: Prototype extruder, pellet cutter and gas gun; fuel recirculation loop; propellant recirculation loop; guide tube selector

## Recent Achievements:

- Fabrication of test articles for extruder
- Fabrication and acceptance test of guide tube selector
- Long-term reliability tests of tritium compatible piston pump for recirculation loop
- Demonstration, on DIII-D, of pellet ELM pacing at 12 X natural rate and associated 12 X reduction in ELM intensity

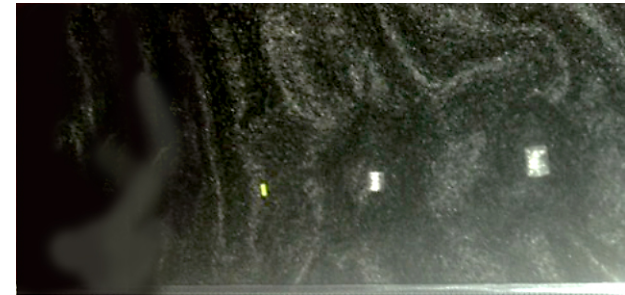

Small pellets from ELM pacing and larger pellets for D/T fueling

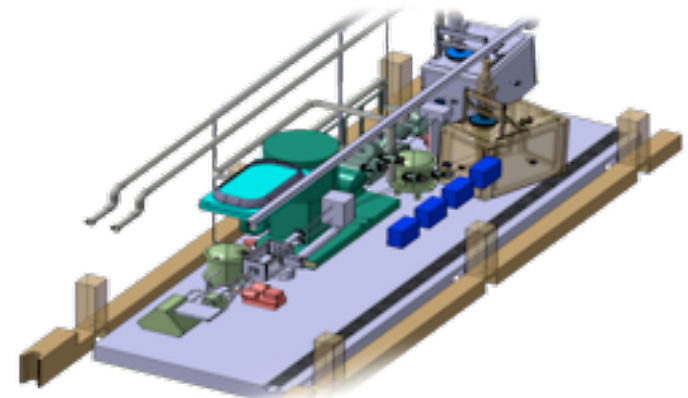

Equipment located in cask for frozen pellet formation, acceleration and recycling of deuterium and tritium gasses.



# Fabrication and Acceptance Test of Guide Tube Selector

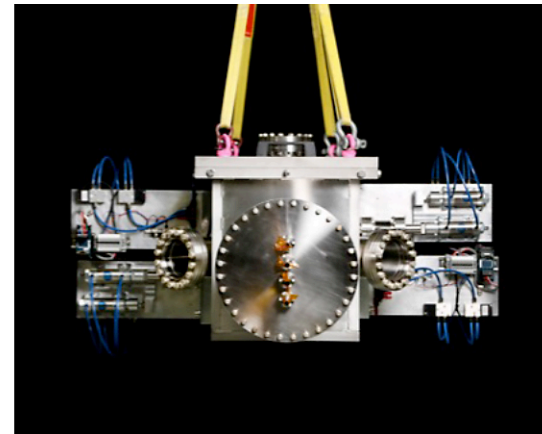
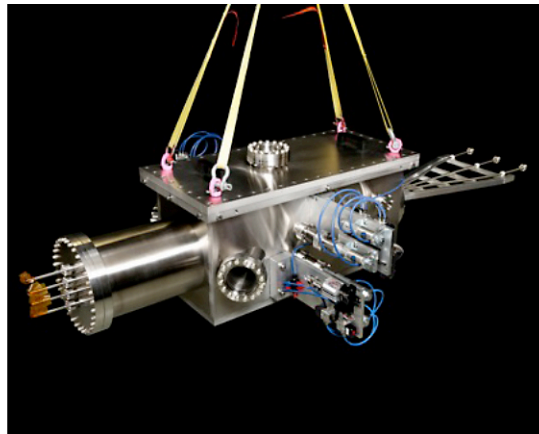
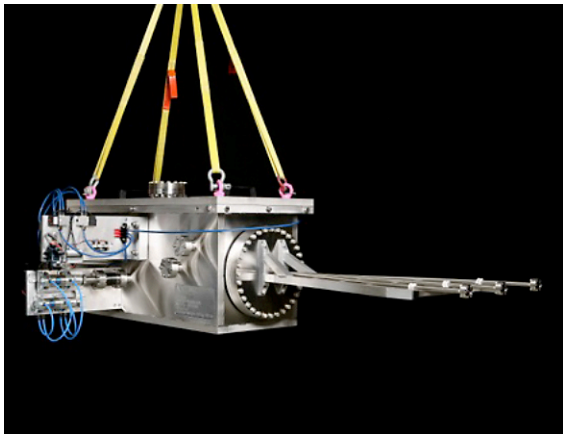

Pellet guide tube selector with internal views of actuators for routing pellets for multiple inputs to multiple outputs

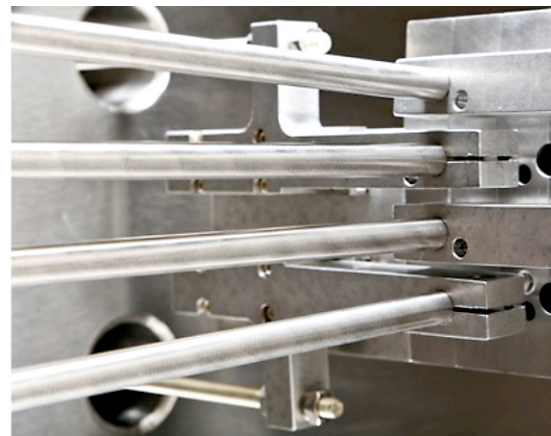
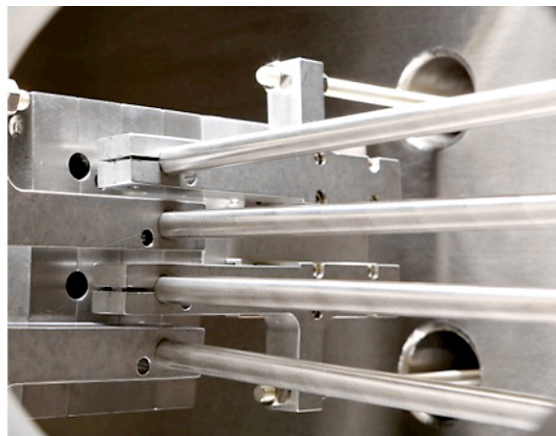
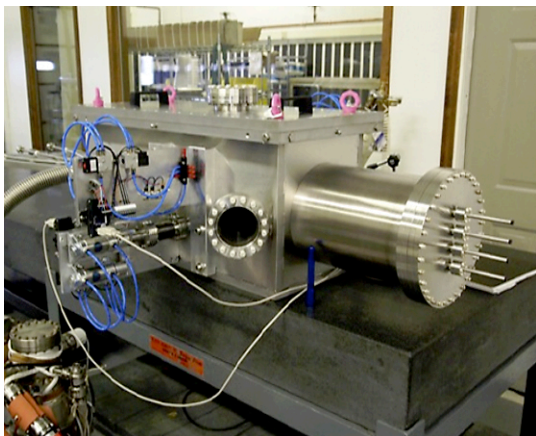

Operation demonstrated at vendor site. Selector shipped to ORNL for pellet tests



# FY 2014 US Achievements

## Massive Gas Injection Valve Prototype

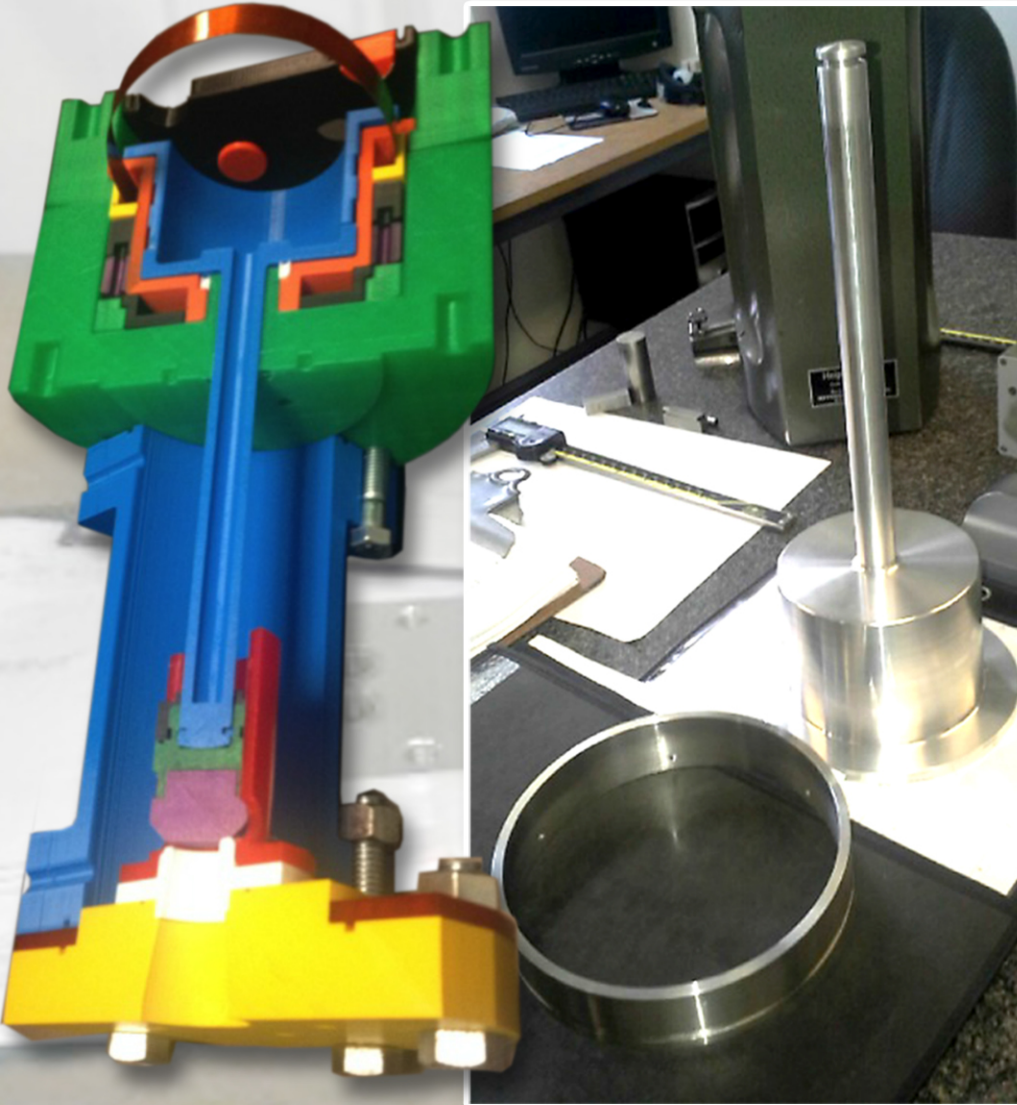

**Valve based on a design used on JET but modified for ITER tokamak environment and injection rate requirements.**

**Modified valve uses flyer plate to achieve fast opening time and incorporates T compatible components**



# FY 2014 US Achievements

## Shattered Pellet Injection 3-Barrel Testing

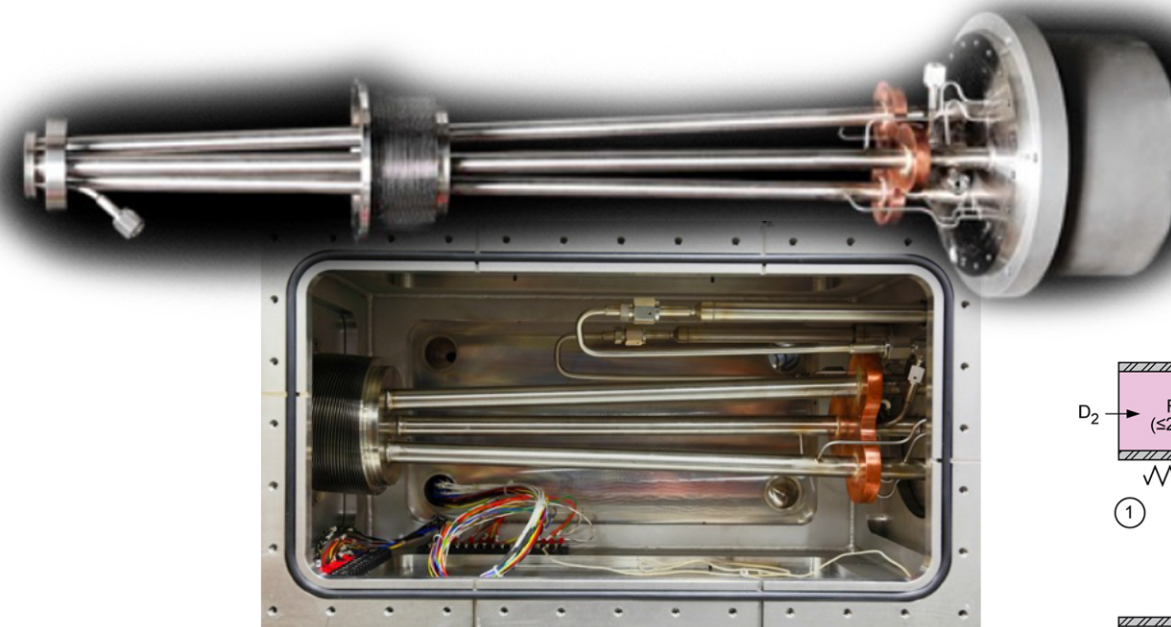

- **Barrel diameter increased to 25 mm (from 16 mm diameter) in order to study scaling of freezing/forming**
- **Larger size will reduce the number of barrels needed for Disruption Mitigation System.**

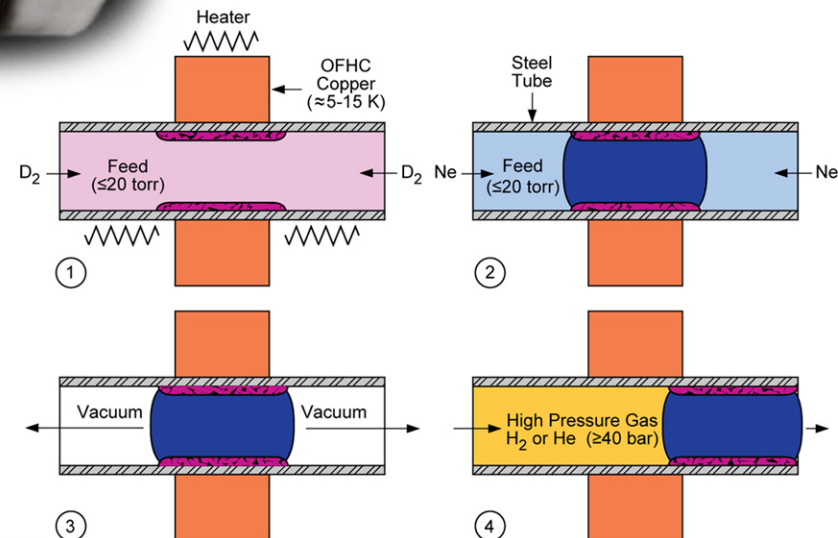

4/1/2010

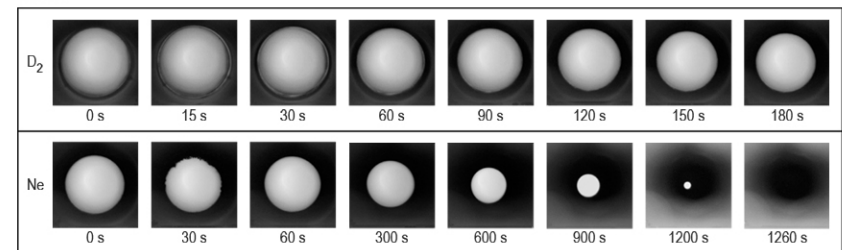



# Deuterium Pellets Formed and Accelerated from Three 25 mm Barrels

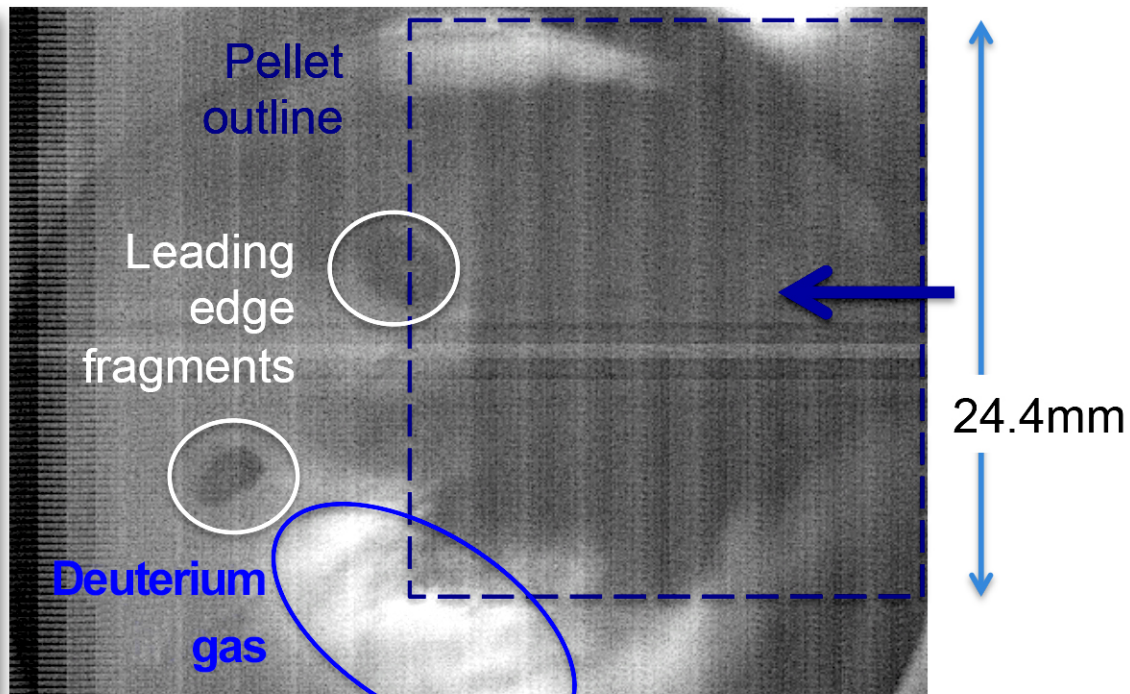

- 3 ea. ~ 25 mm pellets formed and accelerated to 330 m/s
- 1.5 kPa m<sup>3</sup> of deuterium each. 2 pellets exceed the requirement of 2 kPa m<sup>3</sup> for thermal mitigation

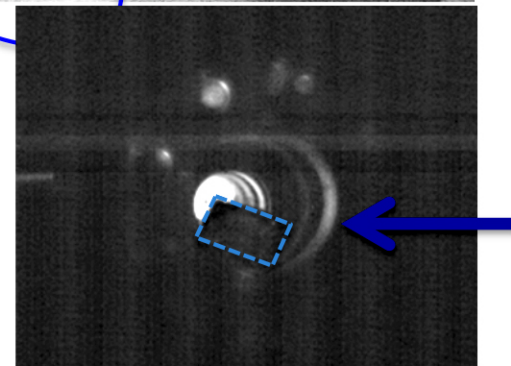



# Ion Cyclotron System Transmission Lines

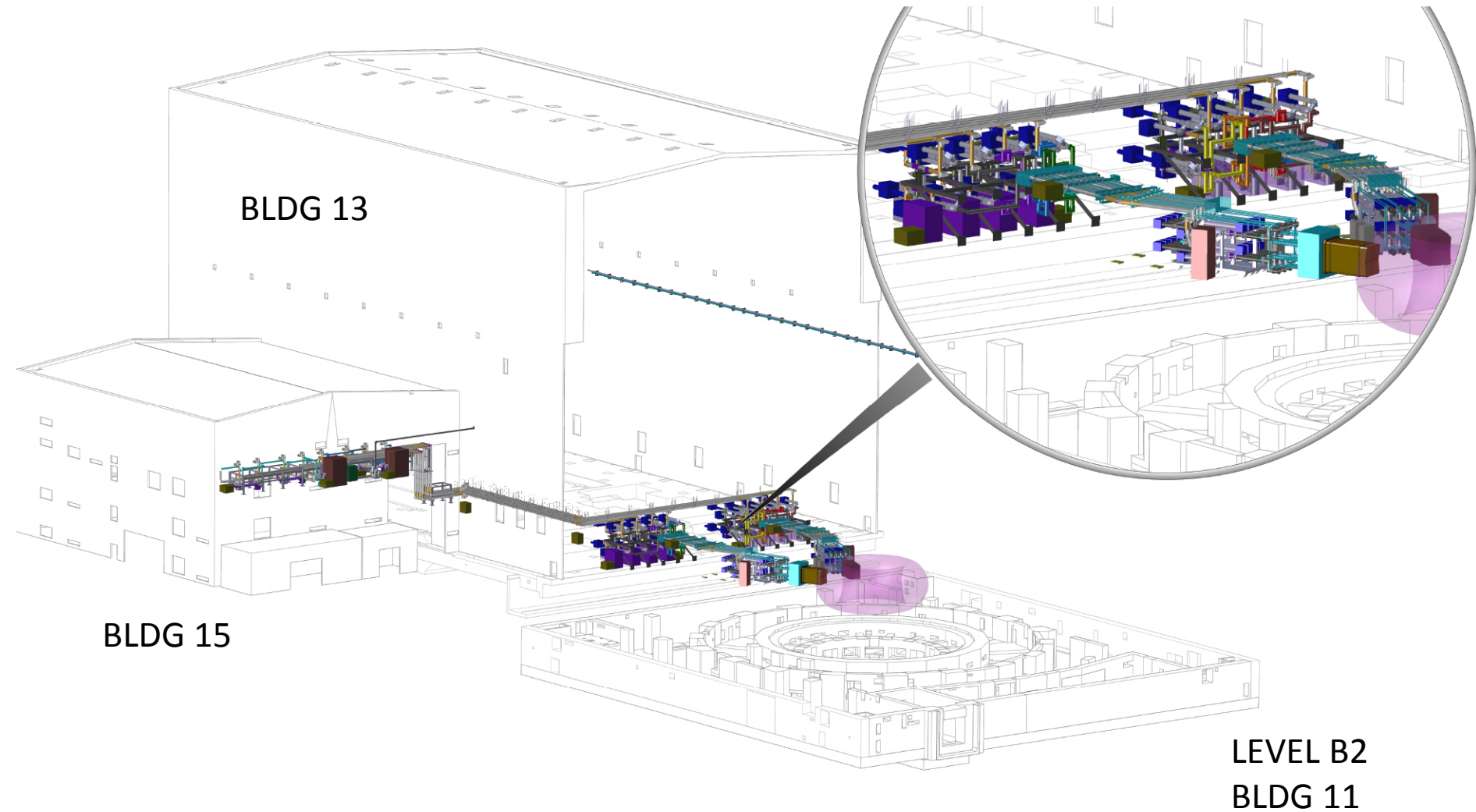



# Ion Cyclotron System Transmission Lines



- Provide efficient transfer of 24 MW 40–55 MHz RF power from sources to plasma antennas using coaxial line and load tolerant matching/tuning
- Transmit up to 6 MW per line for up to 1 hour
- Total of 1.5 km of line connects 8 sources to 16 antenna feeds
- Two 8-channel matching networks weighing 27 t each
- Two 8-channel pre-matching networks weighing 14 t each
- Maximum losses: 2.5% of source power in the transmission line system, 10% in the matching system

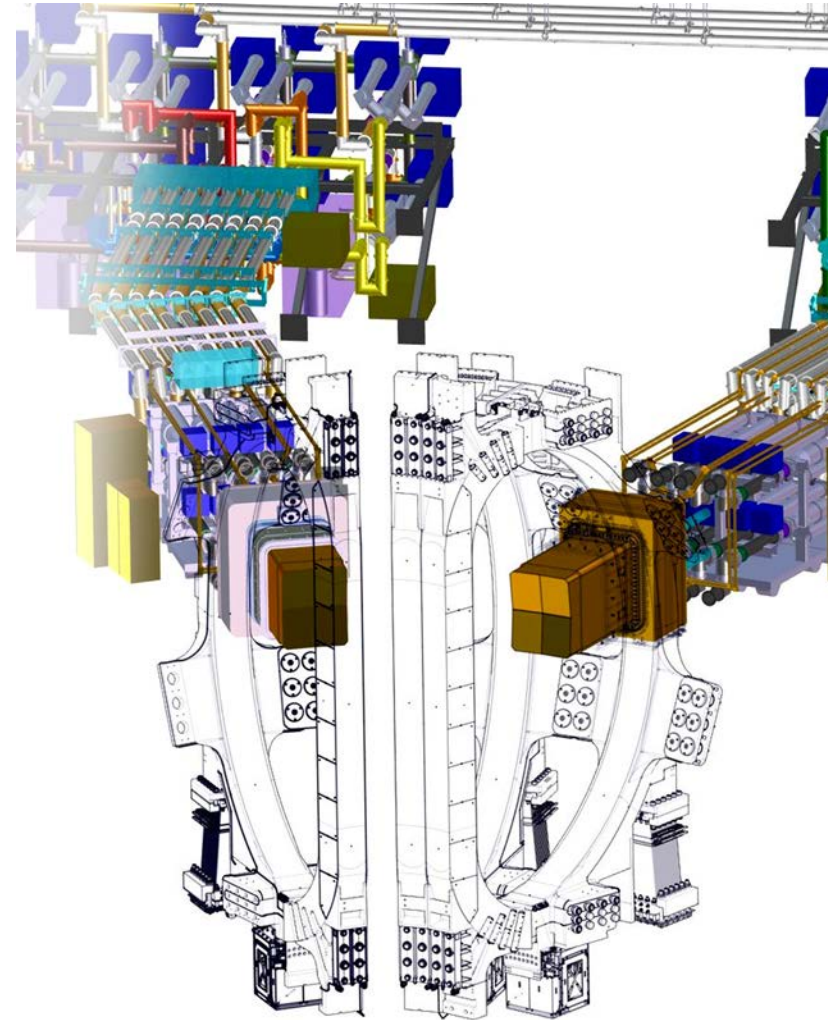



# Ion Cyclotron System Transmission Line and Matching System Status



## Status:

In design: Transmission line components, tuning components, gas cooling system, instrumentation and control

- Successful cooling of inner conductors with circulating air at 3-atmosphere pressure
- High-power (6 MW), high-voltage (40 kV), long-pulse (1 hour) tests of 2 candidate straight transmission lines
- High-voltage (40 kV), long-pulse (1 hour) tests of 3 candidate gas barriers
- Fabrication and performance verification test of 50/50 hybrid power splitter. The power splitter enables passive tolerance to plasma ELM events

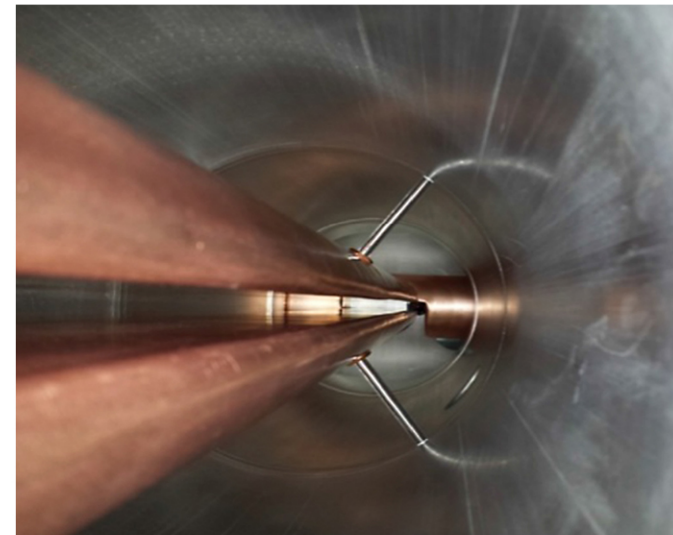
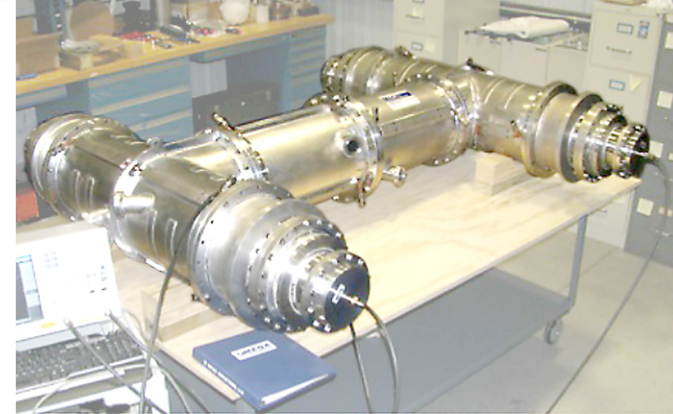

Four-port 50/50 Power splitter on the test bench. Internal view of outer conductor (Al) and inner conductors (CU) of the power splitter (Mega Industries, Portland, Maine)



# Milestone Completed: 3 dB Hybrid Splitter Component Qualification Test

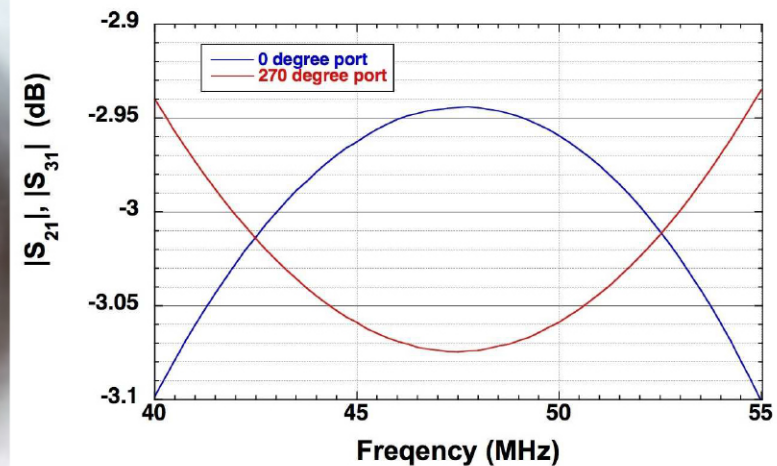
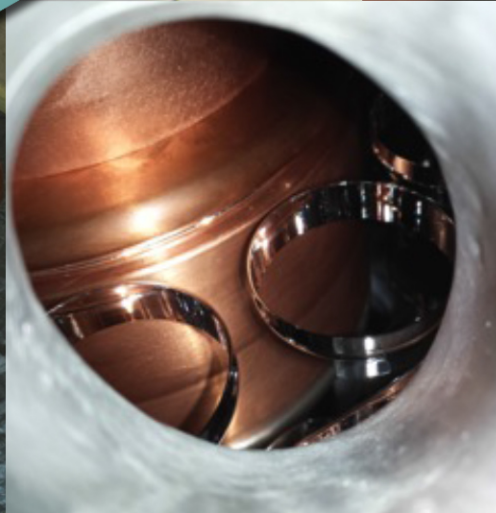
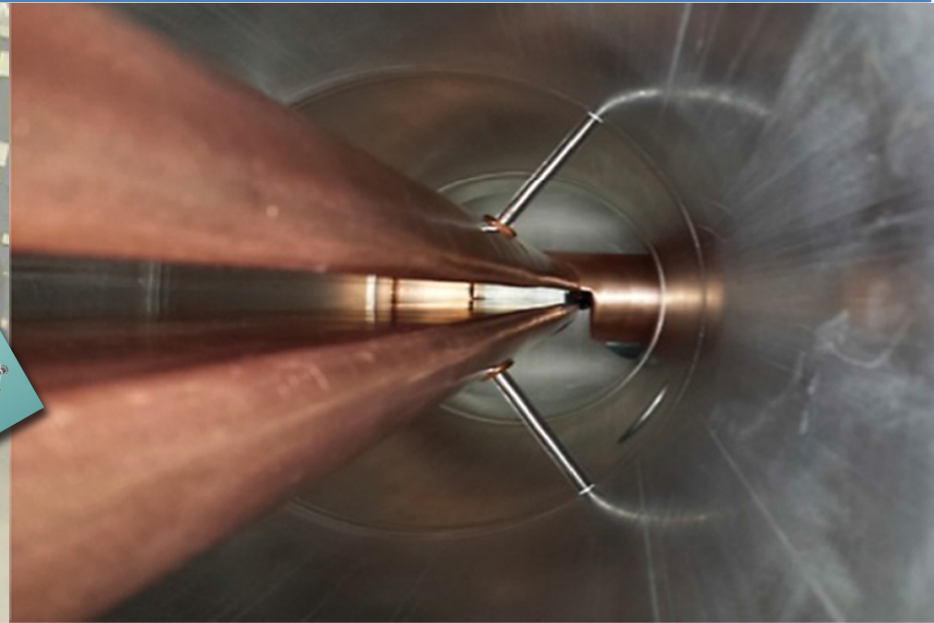
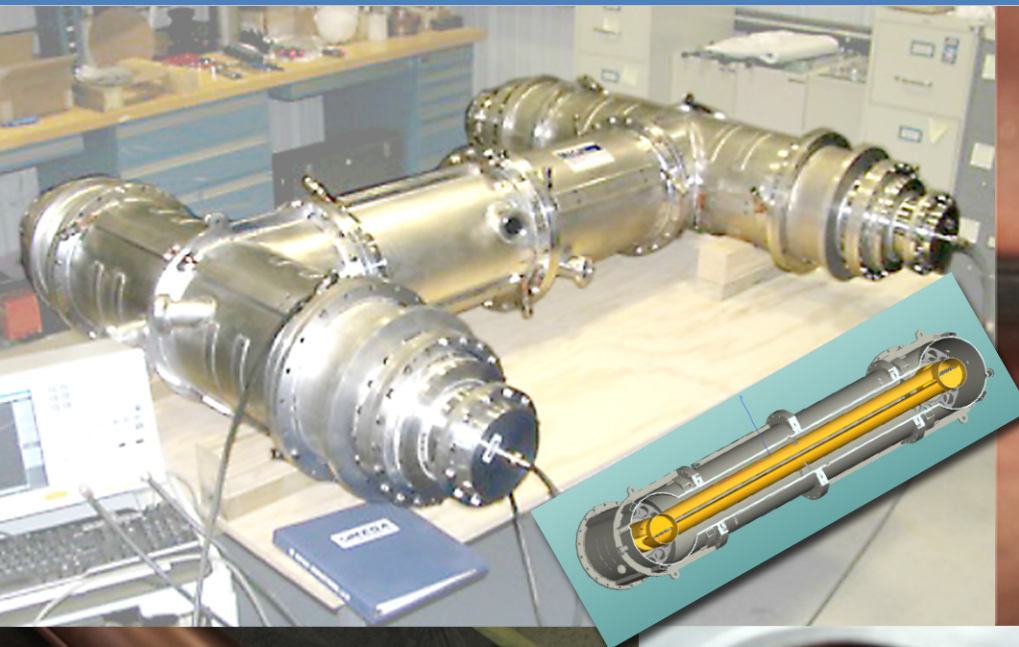



# Electron Cyclotron System Transmission Lines

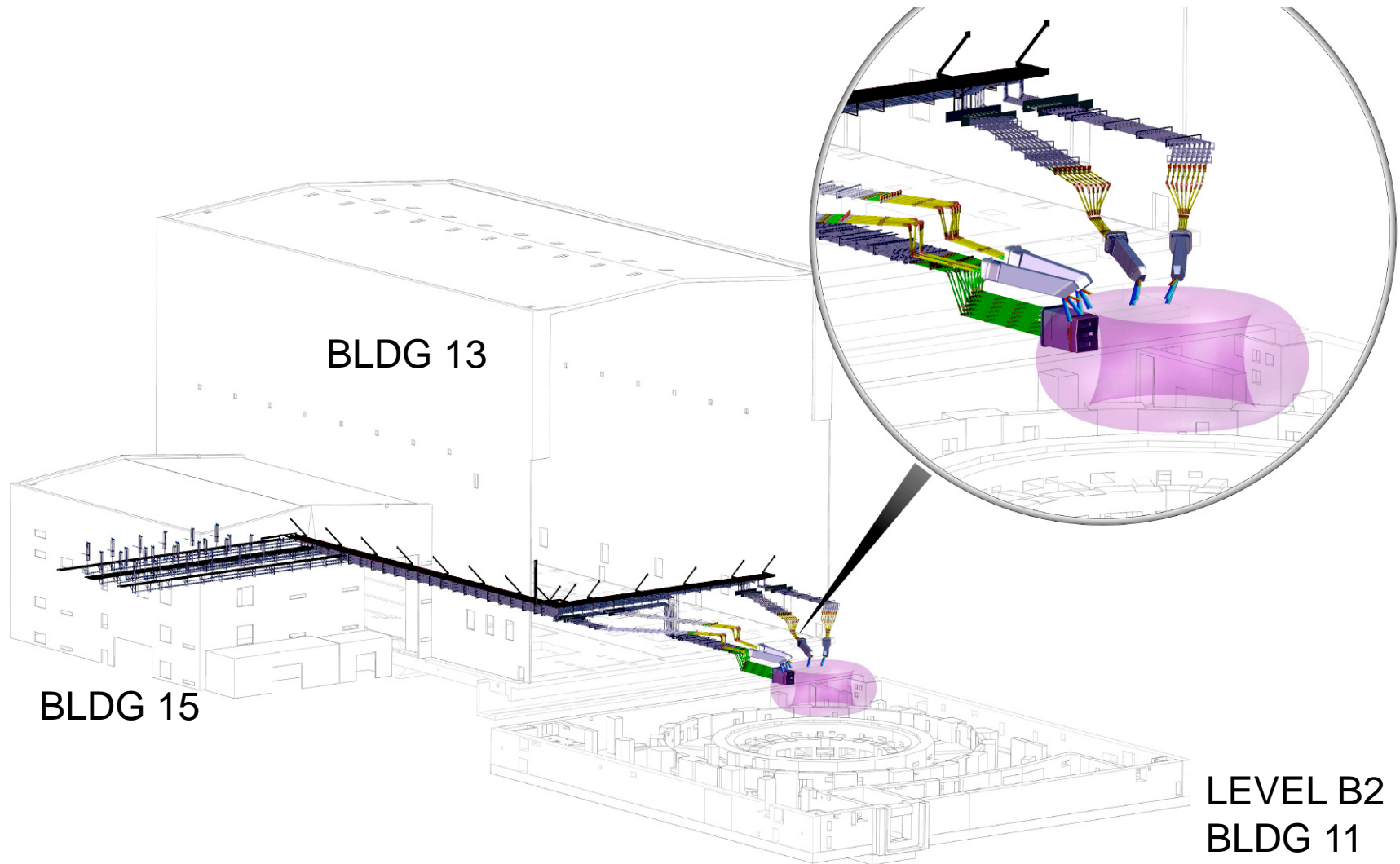



# Electron Cyclotron System Transmission Lines



- Provide efficient power transfer from 170 GHz gyrotron sources to launchers
- Transmit up to 2 MW per line for 1 hour
- Transmission lines from 24 sources to 56 feeds

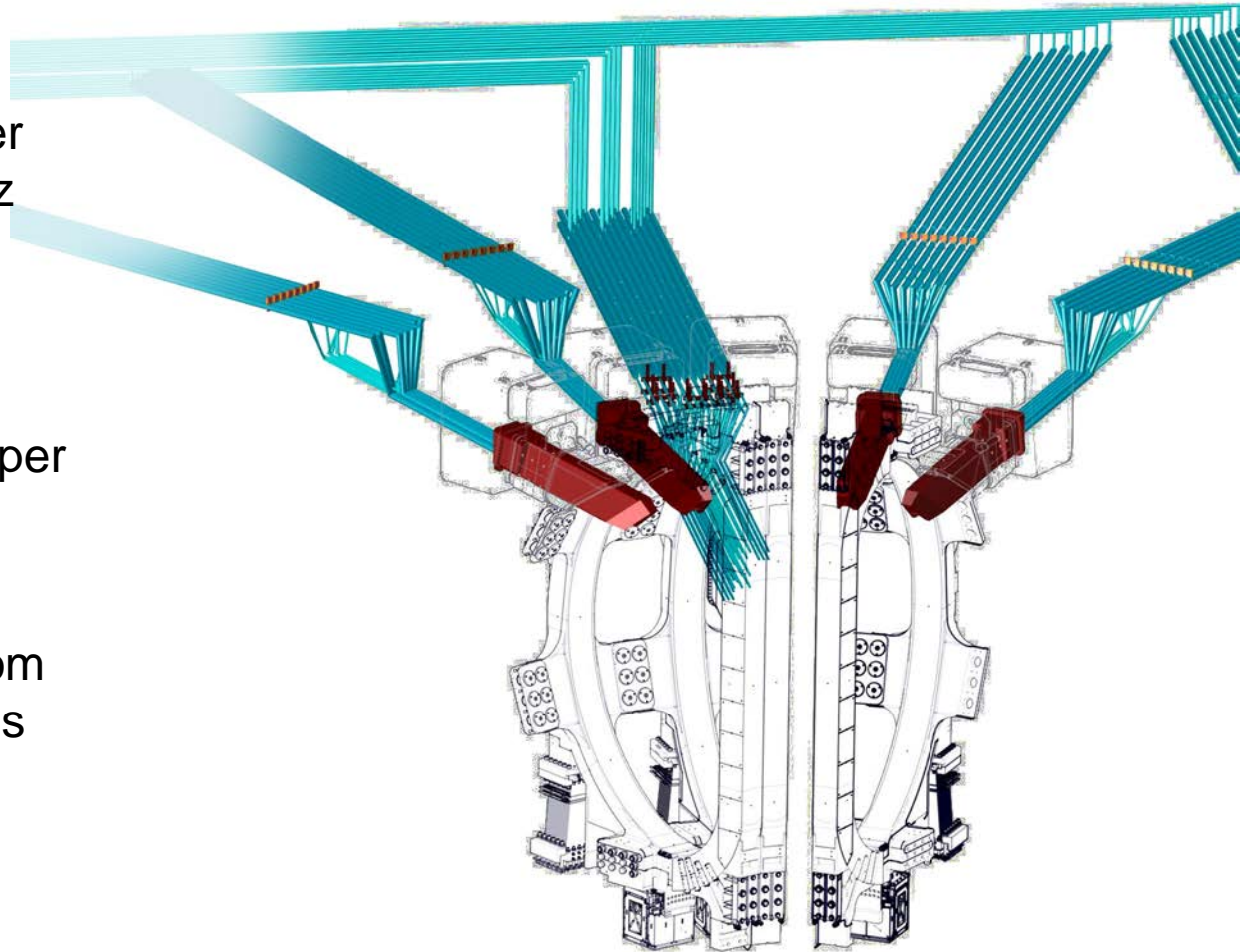

# Electron Cyclotron System Transmission Lines FY 14 Status



## Design Progress: Transmission Line Movement

### TL will move due to:

- Thermal expansion
- Building movements due to external loads

### TL and Support system must be designed to accommodate these movements

- During Operations
  - Minimize extent of WG bending
  - Use Expansion Units to avoid WG bending
  - WG must move axially through supports
- Non-Operational conditions
  - Expansion units to take up some building movements
  - WG bends at building interfaces

**Wind loads on Assembly and RF buildings can cause buildings to move/sway by more than 10 mm**

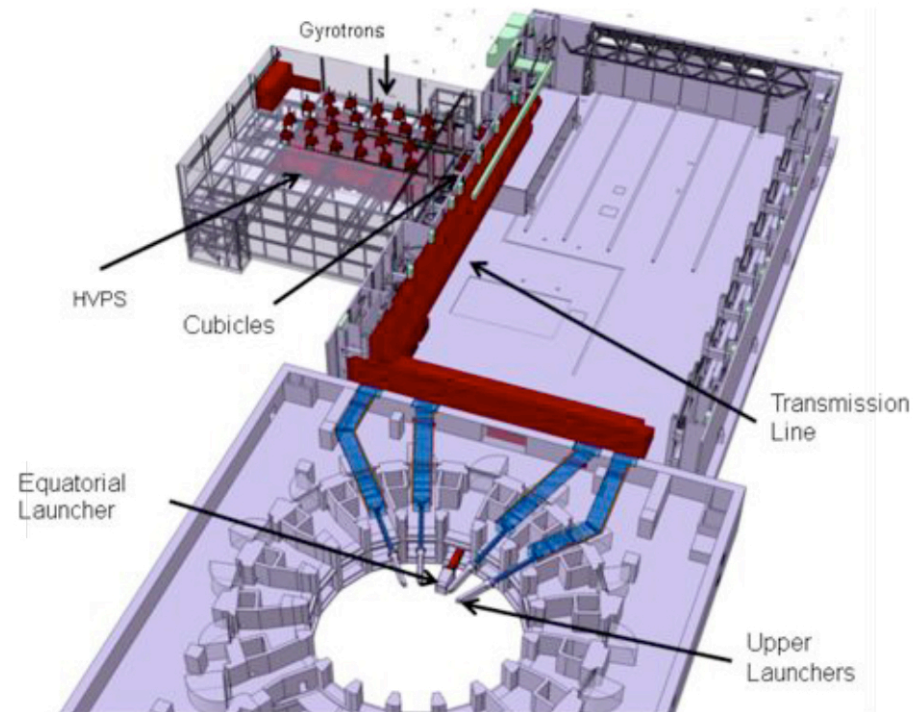



# FY 2014 Achievement 30% Final Design Intermediate Design Review



Modeling of in-line thermal/mechanical expansion compensation ECH transmission line component

Thermal/mechanical expansion component

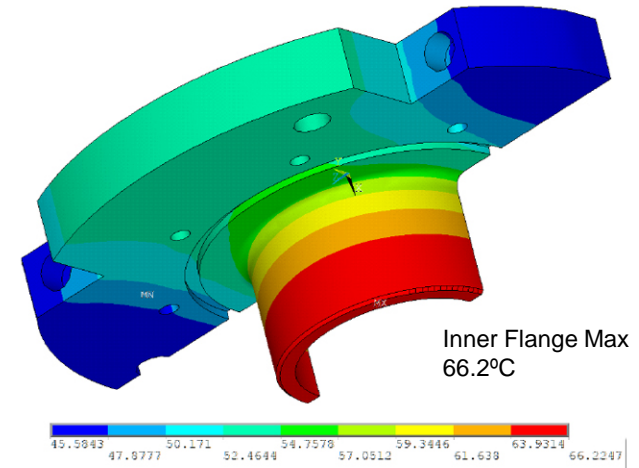
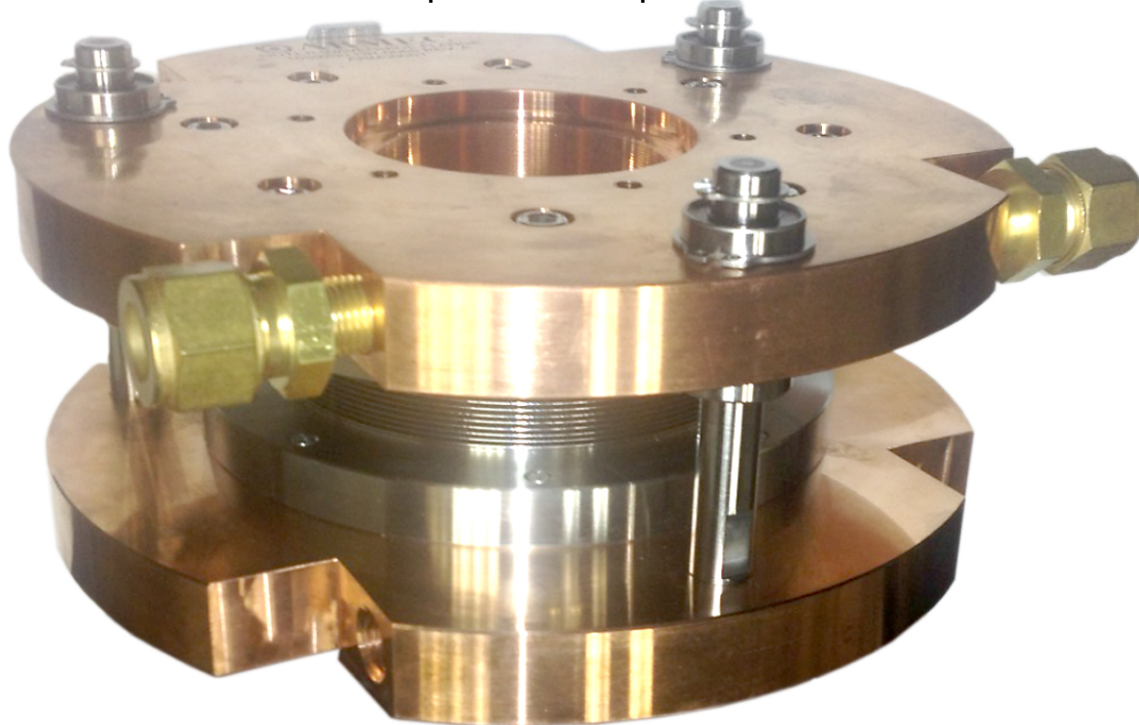

Temperature profile with 5,000 W/m heat load

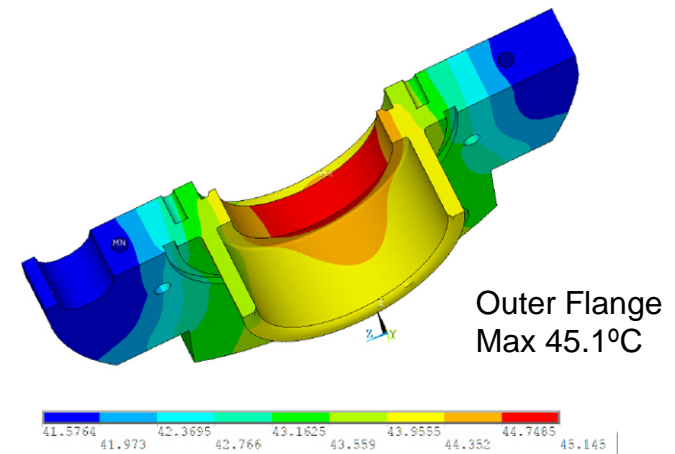

# FY 2014 Achievement Completed Conditioning Power Load SOW

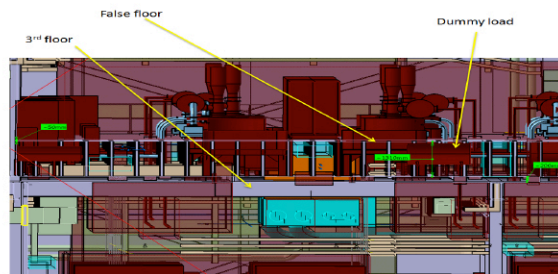
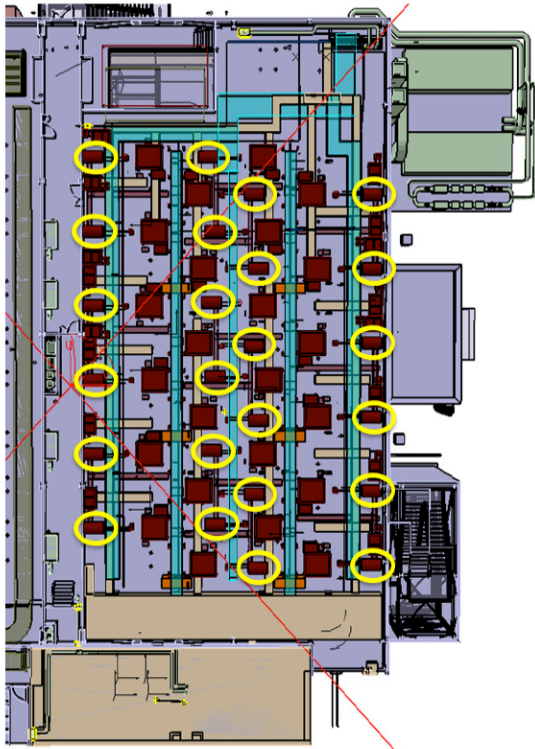



# Vacuum Auxiliary System and Roughing Pumps

## Vacuum Auxiliary System, VAS

## Roughing Pump System

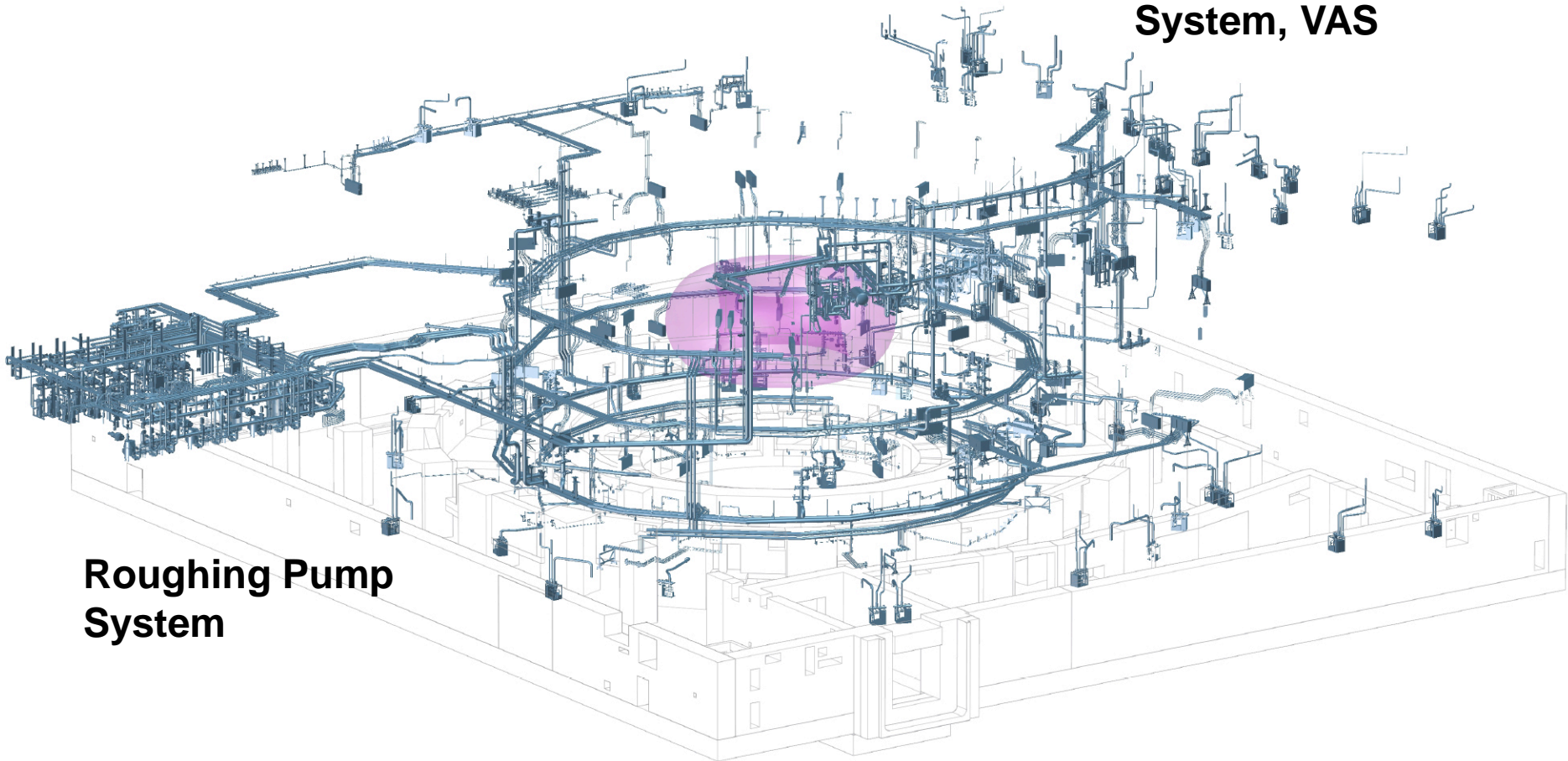

# Vacuum Auxiliary System and Roughing Pumps

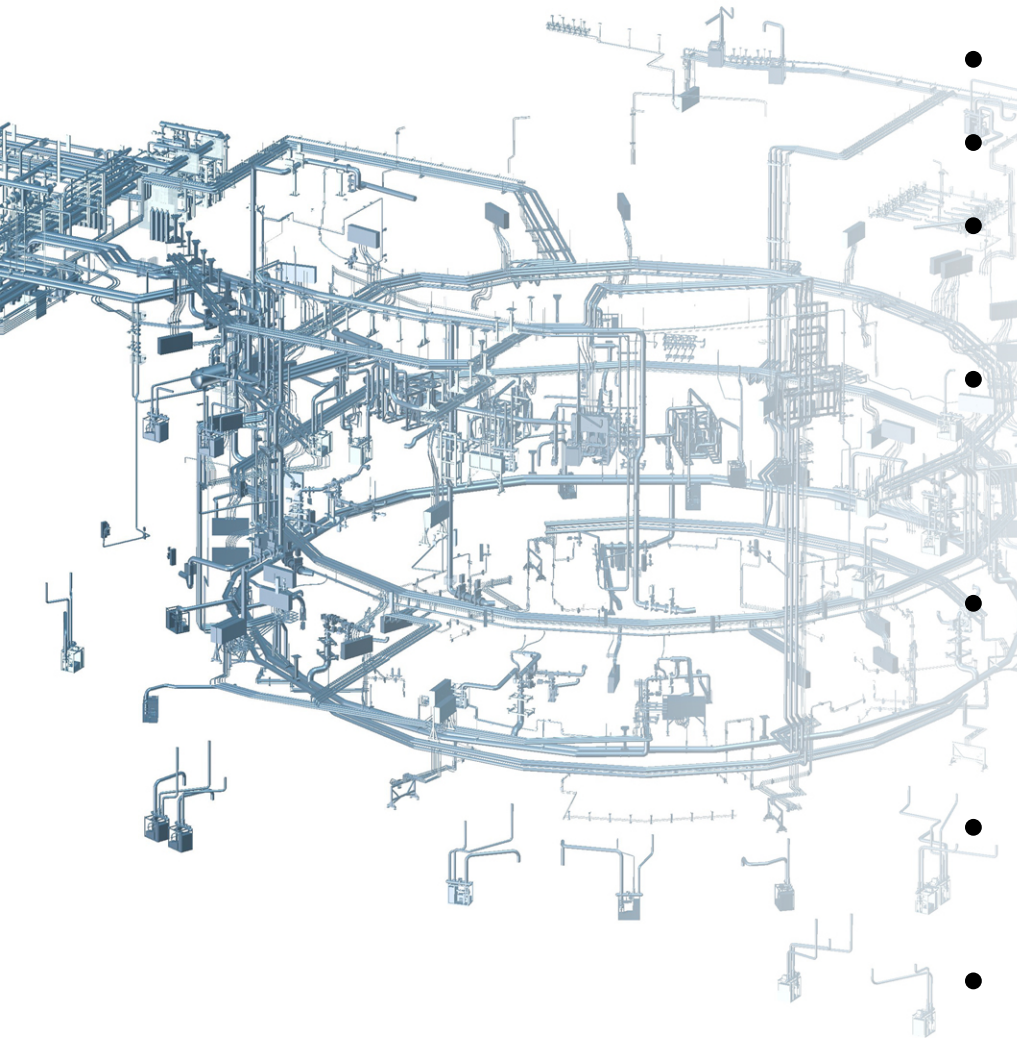

- Tokamak vacuum volume: 1330 m<sup>3</sup>
- Cryostat vacuum volume: 8500 m<sup>3</sup>
- Neutral beam injectors' volume: 8600 m<sup>3</sup>
- Vacuum system performance: 105 Pa to 10 Pa in 24 hours, operating pressure 1 x 10<sup>-4</sup> Pa
- Roughing pumps: 400+ vacuum pumps utilizing 10 different technologies
- Service vacuum system: >1500 clients
- Vacuum piping: 6 km



# Roughing Pump System

## FY 14 Status (1)



- The Roughing Pump System (RPS) achievements for FY14 consist of providing tritium compatible vacuum pump development support via the two Task Arrangements in effect.
- Successful manufacture and testing of the prototype tritium compatible roots and screw pumps
- Testing is underway at present at ORNL

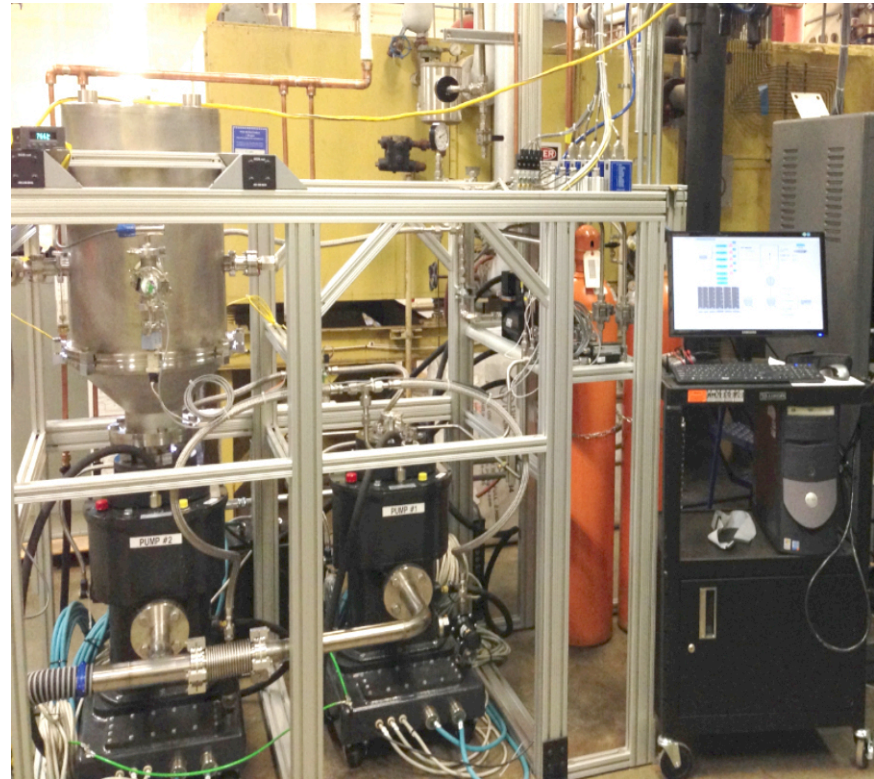

Tritium compatible screw pumps in test stand at ORNL

# Roughing Pump System

## FY 14 Status (2)



CVC assembly undergoing vacuum leak testing

Manufacture of the prototype tritium compatible Cryogenic Viscous Compressor (CVC) is being completed at Major Tool and Machine, Indianapolis, IN



Inner CVC core



Multilayer insulation film surrounds the CVC core



# Diagnosics

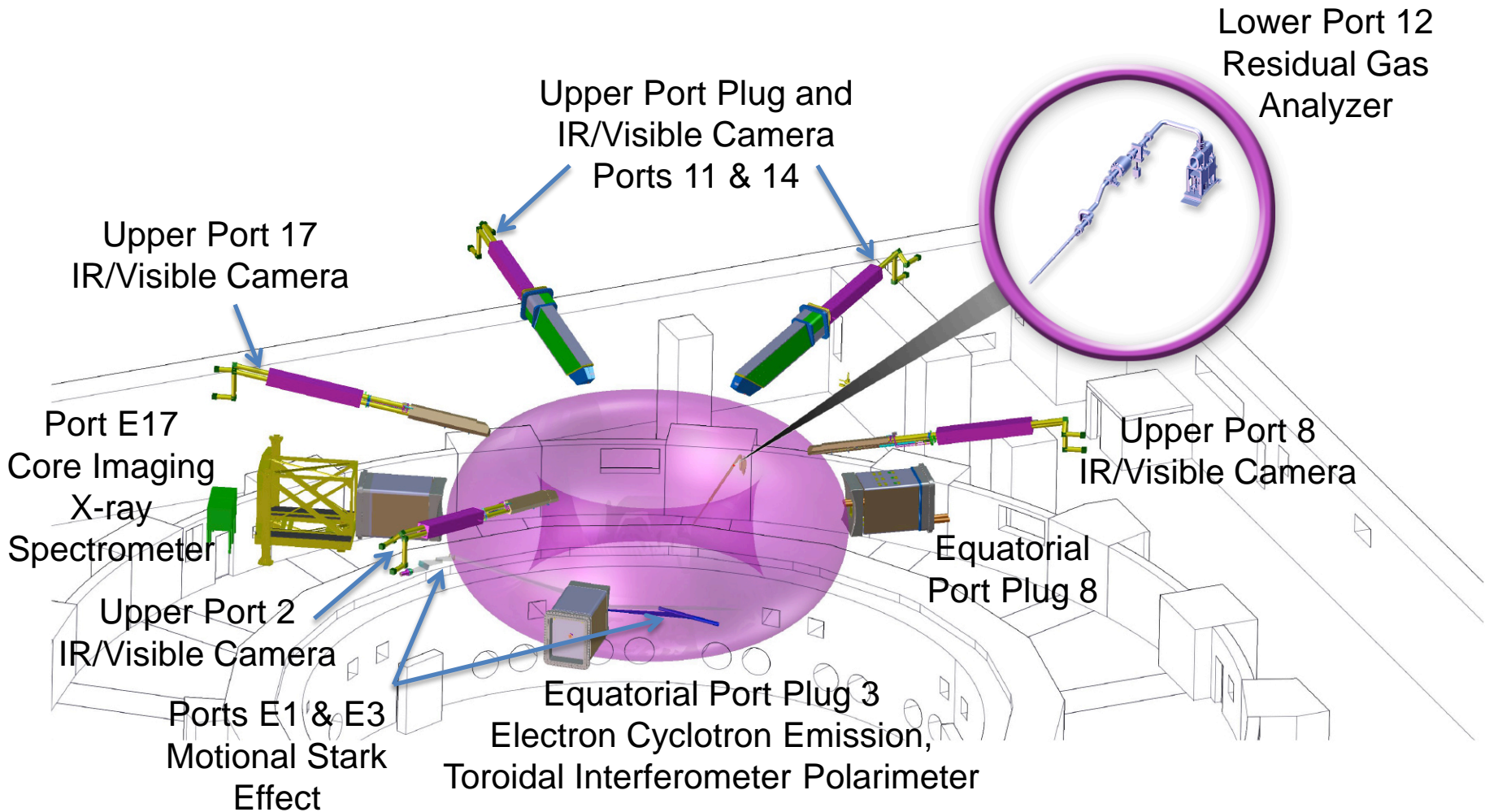

- USIPO is responsible for 14% of port based diagnostic systems, including integration of four diagnostics port plugs and seven instrumentation systems; achievements include:
  - Completed FDR of the Diverter Residual Gas Analyzer (DRGA) Sampling Tube
  - Awarded Subcontract for Low Field Side Reflectometer (LFSR) Physics Design
  - Awarded Subcontract for Electron Cyclotron Emission (ECE) Design
  - Awarded Subcontract for Upper Camera Design
  - Pending award - subcontract for Toroidal Interferometer/Polarimeter (TIP) Design

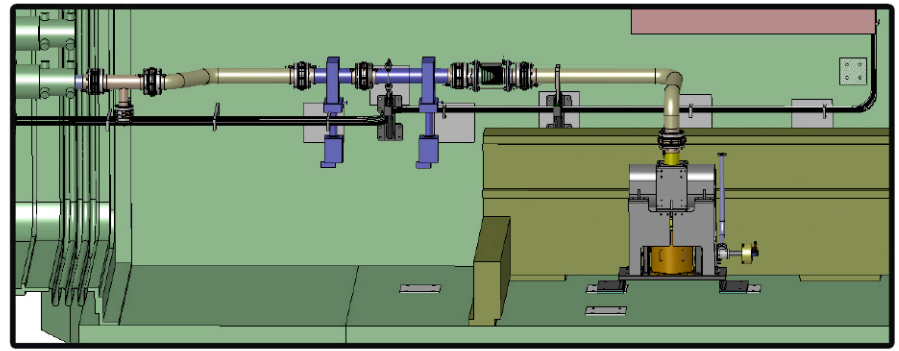
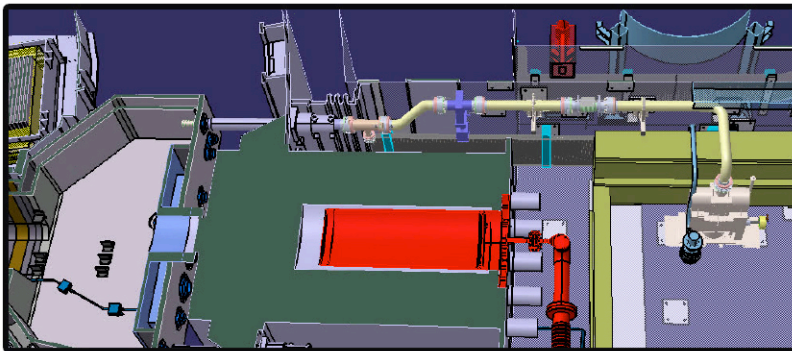

3-D CAD Model of RGA Diagnostic



# Diagnosics

## FY 14 Status



The residual gas analyzer and part of the low-field side reflectometer will be installed for 1<sup>st</sup> Plasma.

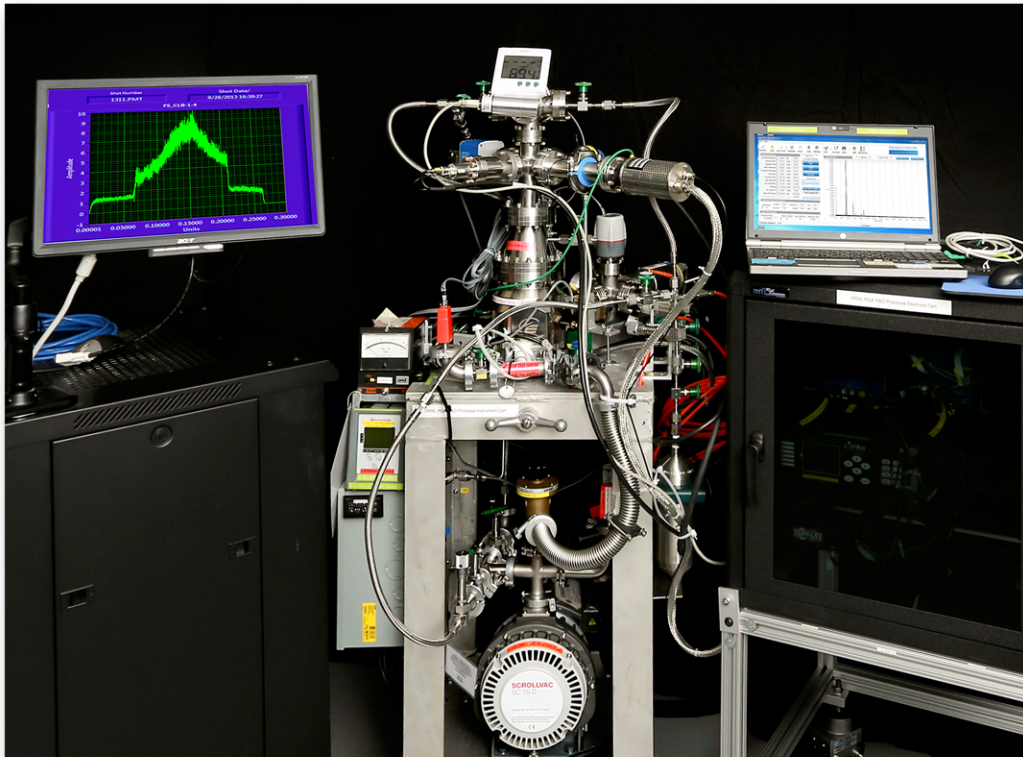

Diagnostic residual gas analyzer in development at ORNL.  
Photo: US ITER/ORNL

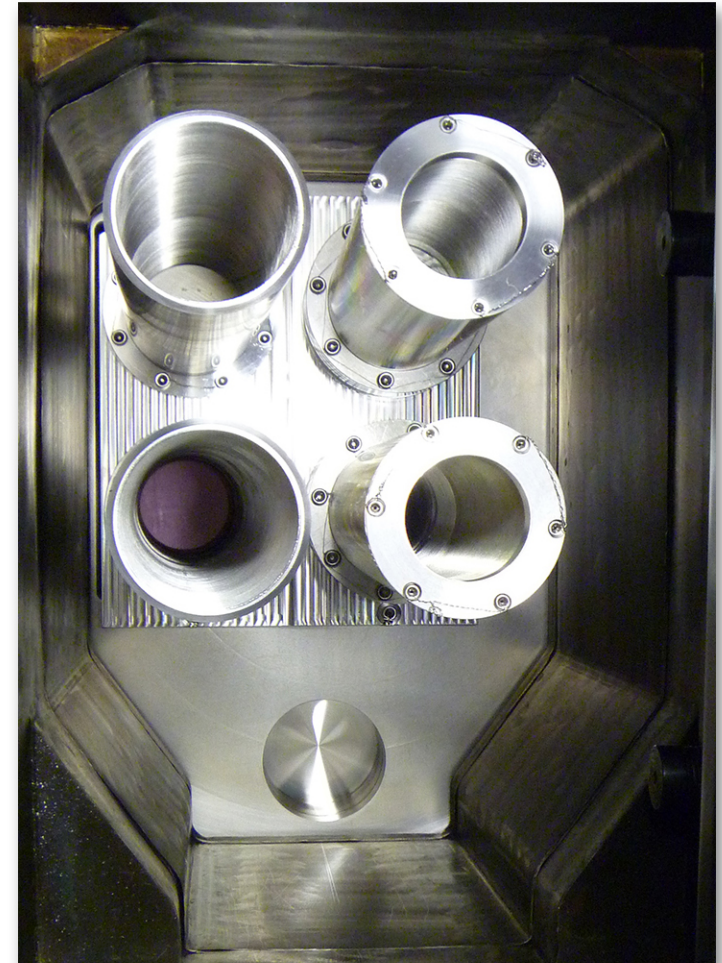

Prototype antenna for the low-field side reflectometer installed on DIII-D.  
Photo: US ITER/ORNL

# Diagnosics Design Status



System	Procurement Arrangement	Design Phase
Upper Port 11	✓	PD
Upper Port 14	✓	PD
Equatorial Port 3	imminent	PD
Equatorial Port 9	✓	PD
Upper Visible/IR Cameras	✓	PD
Low Field Side Reflectometer	✓	PD
Motional Stark Effect Diagnostic	imminent	PD
Electron Cyclotron Emission	✓	PD
Residual Gas Analyzer	✓	FD
Toroidal Interferometer/Polarimeter	✓	PD
Core Imaging X-ray Spectrometer	imminent	PD



# Tokamak Exhaust Processing

## Configuration:

- TEP equipment located in Tritium Building
- Tritium Confinement provided by nitrogen inerted gloveboxes and Tritium Building
- Gamma Decay Tanks located on separate floor

## Status:

- In preliminary design
- TEP required for DT Plasma

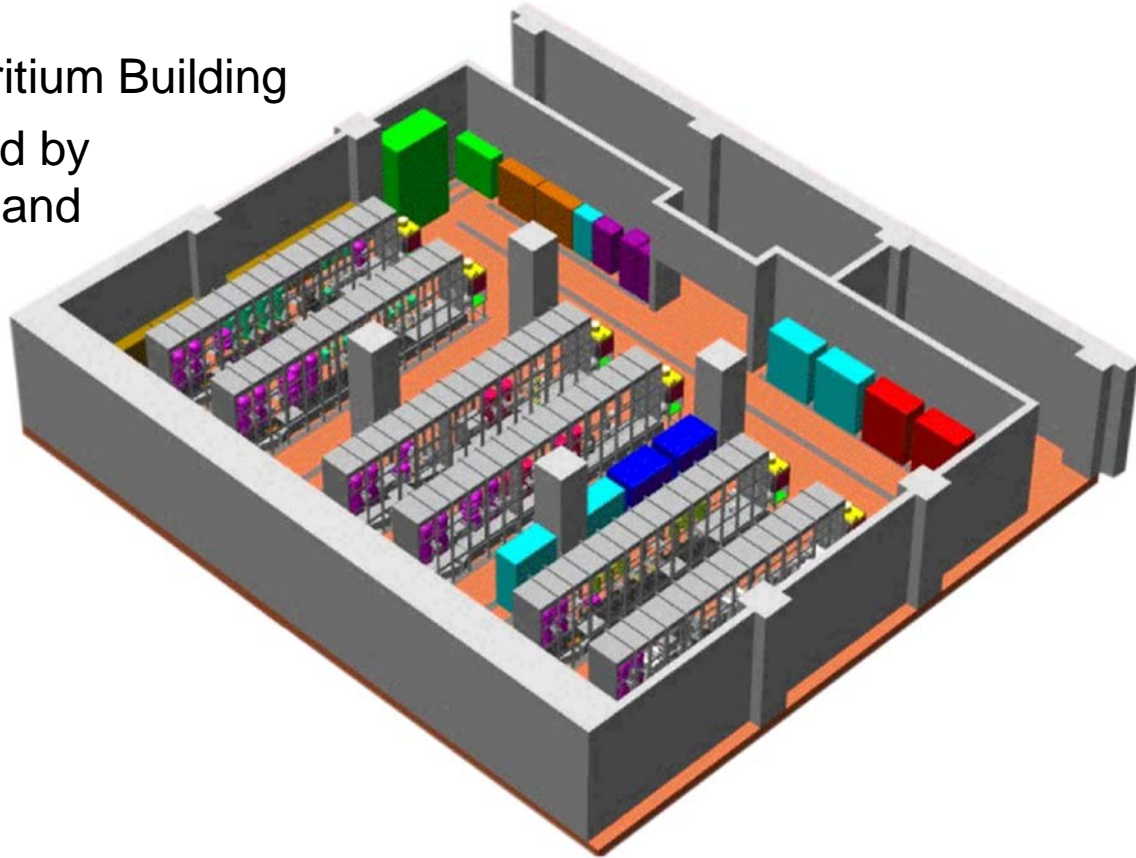

# Some Current Technical Challenges



<b>Tokamak Cooling Water System</b>	<ul style="list-style-type: none"><li>• <b>Finalize 1<sup>st</sup> Plasma scope and requirements</b>, including role in N<sup>16</sup> gamma dose reduction</li><li>• Oversight of IO as TCWS designer and piping manufacturer</li><li>• Design changes that implement design optimization (i.e., Heat Exchanger options)</li></ul>
<b>Ion and Electron Cyclotron Heating Systems</b>	<b>Building interfaces</b> for penetrations through Tokamak Building wall and Port Cell wall for transmission line, services and cabling especially meeting fire requirements
<b>Diagnostics</b>	Meeting <b>radiation shielding</b> requirements in the port plugs while simultaneously satisfying diagnostic measurement requirements and weight limits.



# Summary: Project Execution Well Underway!



**Percent Complete by Phase  
US ITER Project**

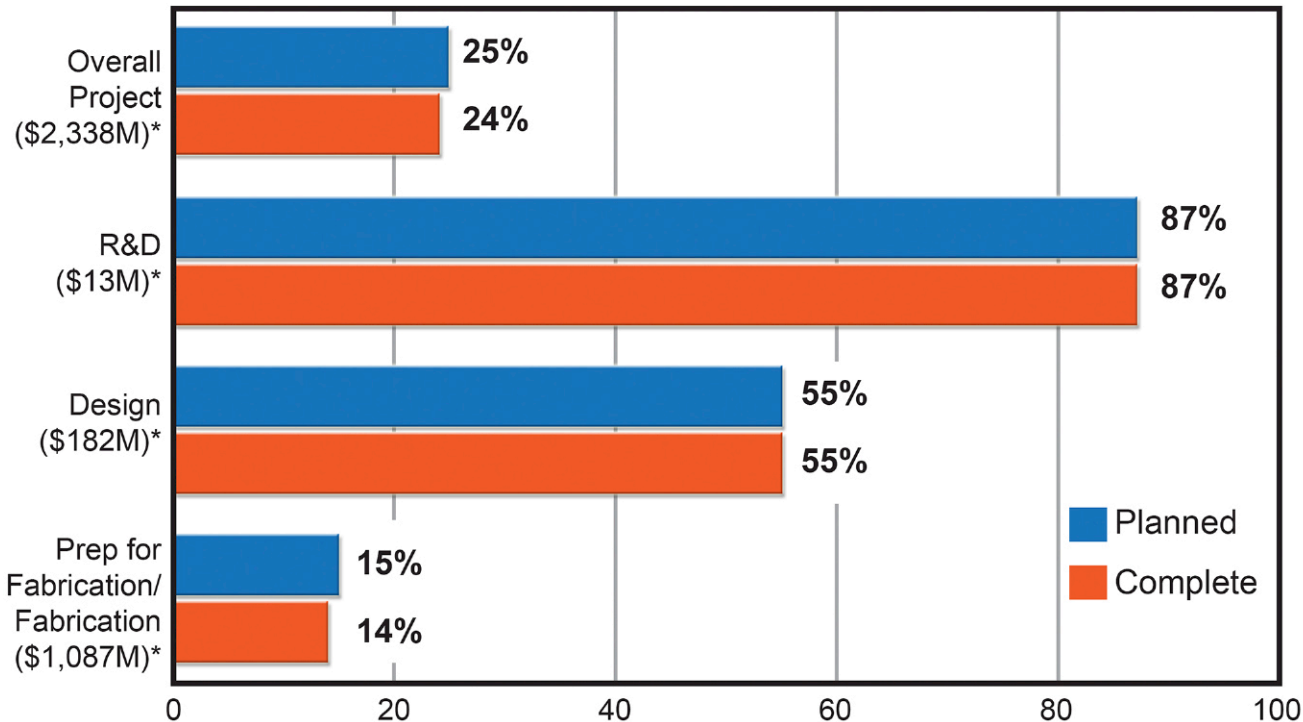

\* ETC, escalated w/o Contingency

**R&D - 87% complete**  
> 100 prototypes/first articles under development

**Significant information gained:**

- Technical feasibility
- Manufacturing issues
- Cost and time to fabricate

**Design - 55% complete**

**Prep for fab/fabrication – 14% complete**

# 5 Hardware Systems in Fabrication



## TF Conductor

- All strand complete
- 1<sup>st</sup> conductor (of 7) fabricated and undergoing leak testing
- 2 production cables are complete and jacketing of 1<sup>st</sup> cable is underway
- **All deliveries will be complete in 2016**

## CS Modules fabrication

- 5 spools of JA conductor received
- Tooling stations being installed
- Mock-up coil fabrication started
- Winding of 1<sup>st</sup> module to begin in 2014

## Tokamak Cooling Water System (TCWS) drain tanks

- All 5 tanks ready for shipment by end of 2014

## Steady State Electric Network (SSEN)

- 11 fabrication contracts in process
- **All deliveries will be complete in 2017**

## Vacuum Auxiliary

- 15 of 16 components for test stand complete



# Design, Contracts, Fabrication, Deliveries



## **Design well underway**

~2/3 (by value) of US Hardware systems in final design or beyond

## **Contracts are in place**

~1/2 (by value and number) of planned contracts have been awarded

**Fabrication underway** for critical-pacing items

**Key hardware deliveries** on-going

## **At the end of FY16:**

- Only one PA remaining
- Design >80% complete
- 28% of US Hardware Deliveries needed for 1<sup>st</sup> Plasma will be complete
- One US Hardware contribution will be complete in FY16 (TF)